

CXE/AVC MODBUS

Universal control module

Operating Instructions



Keep for reference!

Software version: from version 11.15

L-BAL-E230-GB 1546 Index 003

Content

1	General notes	5
1.1	Structure of the operating instructions	5
1.2	Target group	5
1.3	Exclusion of liability	5
1.4	Copyright	5
2	Safety instructions	5
2.1	Intended use	5
2.2	Explanations of symbols	6
2.3	Product safety	6
2.4	Requirements placed on the personnel / due diligence	6
2.5	Start-up and during operation	6
2.6	Work on the device	7
2.7	Modifications / interventions in the device	7
2.8	Operator's obligation of diligence	7
2.9	Employment of external personnel	7
3	Product overview	8
3.1	Operational area	8
3.2	Maintenance	8
3.3	Transport	8
3.4	Storage	8
3.5	Disposal / recycling	8
4	Mounting	9
4.1	General notes	9
4.2	Outdoor installation	9
4.3	Installation location for agriculture	9
4.4	Temperature influences during commissioning	9
5	Electrical installation	10
5.1	Safety precautions	10
5.2	EMC-compatible installation of control lines	10
5.3	Mains connection	10
5.4	Signal input or sensor connection (E1, E2)	11
5.5	Control outputs 0 - 10 V (A1, A2)	11
5.6	Voltage supply for external devices (+24V, GND)	11
5.7	Digital inputs (D1, D2)	11
5.8	Relay outputs (K1, K2)	12
5.9	RS-485 interfaces for MODBUS RTU	12
5.9.1	Addressing member MODBUS Master Interface	13
5.10	USB-interface	15
5.11	Potential at control voltage connections	15
6	Select operation mode	16
6.1	Mode and signal input	16
6.2	Operation with a second control circuit	17
6.3	External Setpoint / External speed setting in manual operation	20
7	Start-up	20
7.1	Prerequisites for commissioning	20
7.2	Procedure for commissioning	20

8	Controls and Menu	22
8.1	Multipurpose LC display and keyboard	22
8.2	Menu operation	23
8.3	Example for programming mode 2.01 in “Base setup ”	23
8.4	Menu structure	24
8.5	Overview menu groups	25
9	Programming	26
9.1	Speed controller 1.01 , 1.02	26
9.1.1	Speed controller with setting by external signal 1.01	26
9.1.2	Speed controller with direct setting by keyboard 1.02	28
9.2	Temperature control 2.01 ... 2.05	30
9.2.1	Basic setting 2.01 ... 2.05	30
9.2.2	Settings for operation modes 2.01 ... 2.05	31
9.2.3	Functional diagrams temperature control	33
9.2.4	Additionally for 2.03 (controller output 2 with function 6A)	34
9.2.5	For mode 2.03 : Relay output for Heating or Cooling	35
9.2.6	For mode 2.03 Relay output for temperature monitoring	36
9.3	Pressure control for condensers refrigeration 3.01 ... 3.04	37
9.3.1	Base setup 3.01 ... 3.04	37
9.3.2	Setting for operation modes 3.01 ... 3.04	38
9.3.3	Functional diagrams pressure control condensers	40
9.4	Pressure control airconditioning 4.01 ... 4.03	41
9.4.1	Base setup 4.01 ... 4.03	41
9.4.2	Setting for operation modes 4.01 ... 4.03	42
9.5	Volume control 5.01 and 5.02	44
9.5.1	Basic setting 5.01 and 5.02	44
9.5.2	Setting for operation modes 5.01 ... 5.02	45
9.6	Air velocity control 6.01	47
9.6.1	Base setup 6.01	47
9.6.2	Settings for operation modes 6.01	48
9.7	Menu group Start	49
9.8	Menu group Info	50
9.9	Controller Setup	51
9.9.1	PIN protection activate, PIN 0010	51
9.9.2	PIN protection activate, PIN 1234	52
9.9.3	Save user settings restore with PIN 9090	52
9.9.4	Sensor Alarm ON / OFF	52
9.9.5	Limit	53
9.9.6	Minimum speed cut off	53
9.9.7	Reverse action of the control function	54
9.9.8	Controller configuration	54
9.9.9	Group control	56
9.9.9.1	Variant “0”: One controlled group and up to three switched groups	57
9.9.9.2	Version “1”: Two controlled groups	59
9.9.10	Display text for external message	60
9.9.11	Offset control signal	60
9.9.12	Selection amplifier (comparator) control circuit 1 or 2 at output A1	61
9.9.13	Data on the total control deviation	61
9.10	IO Setup	62
9.10.1	Analog outputs “A1”/ “A2”	62
9.10.2	Digital inputs “D1” / “D2”	63
9.10.2.1	Menu overview	63
9.10.2.2	Enable ON/OFF function 1D	65
9.10.2.3	External message, Function 2D	65
9.10.2.4	Limit ON / OFF, Function 3D	66
9.10.2.5	Switch over input “E1” / “E2”, function 4D (operation with one control circuit)	66
9.10.2.6	Output control circuit 2 additional to “A2” on “A1”, function 4D	66

9.10.2.7	Set 1/2 or Setpoint 1/2, Function 5D	67
9.10.2.8	Intern / Extern Function 6D	68
9.10.2.9	Automatic control / speed manual Function 7D (mode 2.01)	68
9.10.2.10	Reverse action of control function (2.01), Function 8D	69
9.10.2.11	Switch over Setpoint 1/2 for control circuit 2 9D	69
9.10.2.12	Setting Max. Speed ON / OFF function 11D	70
9.10.2.13	Switch over Setpoint 1/2 and Pband 1/ 2 for control circuit 1 15D	70
9.10.2.14	Switch over Setpoint 1/2 and Pband 1/2 for control circuit 2 16D	71
9.10.2.15	Timer function overwrite 21D	71
9.10.3	Configuration of analog inputs "E1"and "E2"	72
9.10.3.1	Signal adaption E1 and E2	72
9.10.3.2	Inverting analog inputs "E1" / "E2"	74
9.10.3.3	"E1" / "E2" Bus mode	74
9.10.4	Function and inverting for relay outputs "K1" and "K2"	75
9.10.5	COM2 Function	76
9.11	Limits	77
9.11.1	Limit indication depending on modulation	77
9.11.2	Limit indication depending on setting or sensor signal	78
9.11.3	Limit indication depending on (offset) to Setpoint	80
9.12	Timer	81
9.12.1	Timerfunction	81
9.12.2	Setting of time and date	83
9.12.3	Automatic summer time	83
9.12.4	Enter switching times	84
9.12.5	Inverting timer function	86
9.12.6	Overwrite timer function	86
9.12.7	Adjustment of the real time clock	86
9.13	MODBUS Slave	86
9.14	MODBUS Master	87
9.14.1	Automatic addressing	88
9.14.2	Manual addressing	89
9.15	Member MODBUS Master	90
10	Menu tables	91
10.1	Menues of operating modes	91
10.2	Possible allocation of the IOs, PINs	98
11	Diagnostics menu	102
12	Protocol	104
12.1	Display and query of events and malfunctions	104
12.2	Messages and trouble shooting	105
13	Enclosure	108
13.1	Technical data	108
13.2	Connection diagram	109
13.3	Dimensions [mm]	110
13.4	Index	111
13.5	Manufacturer reference	112

1 General notes

1.1 Structure of the operating instructions

**Before installation and start-up, read this manual carefully to ensure correct use!
We emphasize that these operating instructions apply to specific units only, and are in no way valid for the complete system!**

Use these operating instructions to work safely with and on the device. They contain safety instructions that must be complied with as well as information that is required for failure-free operation of the device.

Keep these operating instructions together with the device. It must be ensured that all persons that are to work on the device can refer to the operating instructions at any time.

Keep the operating instructions for continued use. They must be passed-on to all successive owners, users and final customers.

1.2 Target group

The operating instructions address persons entrusted with planning, installation, commissioning and maintenance and servicing and who have the corresponding qualifications and skills for their job.

1.3 Exclusion of liability

Concurrence between the contents of these operating instructions and the described hardware and software in the device has been examined. It is still possible that non-compliances exist; no guarantee is assumed for complete conformity. To allow for future developments, construction methods and technical data given are subject to alteration. We do not accept any liability for possible errors or omissions in the information contained in data, illustrations or drawings provided.

We accept no liability for damage caused by misuse, incorrect use, improper use or as a consequence of unauthorized repairs or modifications.

1.4 Copyright

These operating instructions contain copyright protected information. The operating instructions may be neither completely nor partially photocopied, reproduced, translated or put on data medium without previous explicit consent. Infringements are liable for damages. All rights reserved, including those that arise through patent issue or registration on a utility model.

2 Safety instructions

This chapter contains instructions to prevent personal injury and property damage. These instructions do not lay claim to completeness. In case of questions and problems, please consult our company technicians.

2.1 Intended use



The equipment is to be used solely for the purposes specified and confirmed in the order.

Any other use above and beyond this is considered not for the intended purpose unless agreed otherwise by contract. The manufacturer will not be liable for any damage resulting from this. The individual or company using it bears the sole risk.

Reading these operating instructions and complying with all contained instructions - especially the safety notifications contained therein - are considered part of intended use. To consider is also the manual of attached components. Not the manufacturer, rather the operator of the device is liable for any personal harm or material damage arising from non-intended use!

2.2 Explanations of symbols

Safety instructions are highlighted with warning triangles and are depicted according to the degree of hazard as follows.

	<p>Attention! General hazardous area. Death or severe injury or significant property damage can occur if the corresponding precautions are not taken!</p>
	<p>Danger due to electric current Danger by dangerous, electric voltage! Death or severe injury can occur if the corresponding precautions are not taken!</p>
	<p>Information Important additional information and advice for user.</p>

2.3 Product safety

The device conforms to the state of the art at the time of delivery and is fundamentally considered to be reliable. The device and its accessories must only be used in a flawless condition and installed and operated in compliance with the assembly instructions and/or operating instructions. Operating outside the device's technical specifications (☞ name plate and attachment / technical data) can lead to a defect in the device and additional damage!

In the case of a malfunction or a failure of the equipment check all functions with alarms in order to prevent injury to persons or property. Note possibility of back-up operation. If used in intensive animal environments, any malfunctions in the air supply must be detected as soon as possible to prevent the development of a life-threatening situation for the animals. The design and installation of the system must comply with local regulations and directives. In Germany these include DIN VDE 0100, the animal protection and the keeping of working animals ordinance and the pig-keeping ordinance etc. Also note the instructions of AEL, DLG, VdS.

2.4 Requirements placed on the personnel / due diligence

Persons entrusted with the planning, installation, commissioning and maintenance and servicing in connection with the frequency inverter must have the corresponding qualifications and skills for these jobs.

In addition, they must be knowledgeable about the safety regulations, EU directives, rules for the prevention of accidents and the corresponding national as well as regional and in-house regulations. Personnel to be trained or instructed and apprentices are only permitted to work on the device under the supervision of an experienced person. This also applies to personnel undergoing general training. Comply with the legal minimum age.

2.5 Start-up and during operation



Attention!

- During commissioning, unexpected and hazardous conditions can arise in the entire installation due to defective adjustments, defective components or incorrect electrical connections. Remove all persons and objects from the hazardous area.
- During operation, the device must be closed or installed in a control cabinet. Fuses may only be replaced by new ones and must not be repaired or bypassed. The data for the maximum line fuse are to be considered absolutely (☞ Technical data). Use only fuses specified in schematic diagrams.
- Any faults detected in the electric system/modules/operating equipment must be corrected immediately. If these faults are not corrected, the device/system is potentially very dangerous. The device/system must therefore not be operated when it is faulty.
- Pay attention to smooth, low vibration running of the motor/fan, the appropriate instructions in the drive documentation must be observed!

2.6 Work on the device



Information

Mounting, electrical connection, and start-up operation may only be carried out by an electrical specialist in accordance with electrotechnical regulations (e.g. EN 50110 or EN 60204)!



Danger due to electric current

It is generally forbidden to carry out work on electrical live parts. Protection class of the device when open is IP00! It is possible to touch hazardous voltages directly.

The safe isolation from the supply must be checked using a **two-pole** voltage detector.



Attention!

Automatically restart after a power failure or mains disconnection!

2.7 Modifications / interventions in the device



Attention!

For reasons of safety, no unauthorized interventions or modifications may be made on the device. All planned modifications must be authorized by the manufacturer in writing.

Only use the manufacturer's original spare parts / wearing parts / accessories. These parts are specially designed for this device. If parts from other sources are used, there is no guarantee that they are designed and produced for the proper loads and with the required level of safety. Parts and special equipment not supplied by the manufacturer are not approved for use.

2.8 Operator's obligation of diligence

- The contractor or owner must also ensure that the electric systems and equipment are operated and maintained in accordance with electro-technical regulations.
- The owner is obliged to ensure that the device is operated in perfect working order only.
- The device may only be used as intended (☞ "area of application").
- You must periodically examine the safety equipment for their properly functioning condition.
- The assembly instructions and/or operating instructions are always readily available at the location where the device is being used, are complete and are in legible condition.
- These persons are regularly instructed in all applicable questions regarding occupational safety and environmental protection and are knowledgeable regarding the assembly instructions and/or operating instructions and, especially, are familiar with the safety instructions contained therein.
- All safety and warning notices attached to the device are never removed and remain legible.

2.9 Employment of external personnel

Maintenance and service work are frequently carried out by external employees who often do not recognize the specific situations and the thus resulting dangers. These persons must be comprehensively informed about the hazards in their area of activity.

You must monitor their working methods in order to intervene in good time if necessary.

3 Product overview

3.1 Operational area

The purpose of the device is to reach and maintain the target values set. To accomplish this, the measured actual value (sensor value) is compared with the adjusted target value, and the controlled value is deduced from this.

The device has two separate control circuits and two sensor inputs (0 - 10 V, 4 - 20 mA, KTY 81-210, PT 1000).

Speed controllers for fans or fans with an integrated controller can be activated via the 0 - 10 V signal or the parallel option of the MODBUS Master interface.

3.2 Maintenance

The device must be checked for soiling and, if necessary, cleaned in periodic intervals.

3.3 Transport

- The device is packed ex factory to suit the transport method previously agreed.
- Always use the original packaging materials when transporting the device.
- Avoid shocks and impacts to the device during the transport.
- During manual handling the human lifting and carrying restrictions must be observed and adhered to.

3.4 Storage

- The device must be stored in its original packaging in a dry and weather-proof room.
- Avoid exposure to extreme heat and cold.
- Avoid over-long storage periods (we recommend a maximum of one year).

3.5 Disposal / recycling



Disposal must be carried out professionally and in an environmentally friendly way in accordance with the respective national legal stipulations.

- ▷ Separate the materials by type and in an environmentally friendly way.
- ▷ If necessary, commission a specialist company with the waste disposal.

4 Mounting

4.1 General notes



Attention!

The following points must be complied with during the mechanical installation to avoid causing a defect in the device due to assembly errors or environmental influences:

- Before installation remove the device from the packing and check for any possible shipping damage!
- Assemble the device on a clean and stable base. Do not distort during assembly! Use the appropriate mounting devices for proper installation of the unit!
- Do not mount equipment on vibrating base!
- When mounted onto lightweight walls, there must be no impermissibly high vibrations or shock loads. Any banging shut of doors that are integrated into these lightweight walls, can result in extremely high shock loads. Therefore, we advise you to decouple the devices from the wall.
- Do not allow drilling chips, screws and other foreign bodies to reach the device interior!
- The device should be installed in a location where it will not be disturbed, but at the same time can be easily accessed!
- Depending on the housing model use supplied stoppers for cable inlets, cut off necessary cable inlets respectively to the cable diameter. Or alternative use cable inlet for cable glands. Any cable ducts openings not used must be sealed!
- Care must be taken to avoid direct radiation from the sun!
- The device is designed for vertical installation (cable inlet down). A horizontal or reclined installation is only permissible after technical release of the manufacturer!
- Be sure to observe proper heat dissipation (☞ Technical data, heat dissipation).

4.2 Outdoor installation

Outdoor installation is possible up to -20 °C when the controller supply is not switched off. Installation must be protected from the effects of weather as much as possible, including protection from direct sunlight!

4.3 Installation location for agriculture

When using for animal keeping, do not install the device directly in the stable but in a separate room with a lower pollutant load. This helps to avoid damages caused by pollutant gases (e.g. ammonia fumes, hydrogen sulphide fumes).

4.4 Temperature influences during commissioning

Avoid condensation in the controller and functional faults attributable to condensation by storing the controller at room temperature!

5 Electrical installation

5.1 Safety precautions



Danger due to electric current

- Work on electric components may only be carried out by trained electricians or by persons instructed in electricity under the supervision of an electrician in accordance with electrical engineering regulations.
- The 5 electrical safety rules must be observed!
- **It is forbidden to carry out work on electrically live parts.**
- Other measures may be necessary to achieve safe electrical isolation.
- A second person must always be present when working on energized parts or lines who disconnects in case of emergency.
- Inspect electrical equipment periodically: retighten loose connections – immediately replace damaged lines and cables.
- Always keep switch cabinets and all electrical supply facilities locked. Access is only allowed for authorized persons using a key or special tool.
- Operating the device with the housing cover removed is prohibited because energized, exposed parts are present inside the device. Disregarding this regulation can lead to severe personal injury.
- The required protective earth connection is established using screws between the housing parts in metal terminal space covers and housing casings. Commissioning is only permissible after these screws have been properly attached!
- The device owner is responsible for the EMC of the entire plant according to the locally applicable standards.
- Metal screwed-connections are not permitted in plastic housing parts because there is no potential equalization.
- Never clean electrical equipment with water or similar liquids.



Information

The respective connections are represented in the enclosure of this manual (☞ Connection diagram)!

5.2 EMC-compatible installation of control lines

Pay attention to sufficient distance from powerlines and motor wires to prevent interferences. The control cable may not be longer than 30 m. Screened control cables must be used when the cable length is longer than 20 m. When using a shielded cable connect the shielding to one side only, i.e. only to the control unit with the protective ground (keep cable short and with as little inductance as possible!).

5.3 Mains connection

Power from the mains is connected to terminals: PE, L1 and N. Here, it must be strictly observed that the mains voltage lies within the allowable tolerance specifications (☞ Technical data and nameplate affixed to the side).



Danger due to electric current

The mains voltage must comply with the DIN EN 50160 quality characteristics and the defined standard voltages in IEC 60038!

5.4 Signal input or sensor connection (E1, E2)

The unit has two analog inputs: Analog In 1 = "E1" and Analog In 2 = "E2"

The connection is independent of the programmed operating mode and from the sensor signal employed.

- When connecting **passive** temperature sensors TF.. (KTY81-210) or PT1000 at terminals "E1" and "T" or "E2" und "T" must be paid attention to no polarity.
For a high interference immunity a capacitor must be connected directly to the sensor (1 nF parallel). With temperature sensors type TF.. (KTY81-210) a capacitor is integrated.
- When connecting **aktive** sensors at the terminals "E1" and "GND" or "E2" and "GND" attention must be paid to correct polarity, a 24 V DC power supply is integrated.
- For sensors in two-wire-technology (4 - 20 mA signal), the connection is made on the "E1" and "24 V" or "E2" and "24 V", "GND" terminal is omitted.



Danger due to electric current

Never apply line voltage to analog inputs!

5.5 Control outputs 0 - 10 V (A1, A2)

The analogue outputs can be used to activate a speed controller with 0 - 10 V input for example. Fans with integrated controller and 0 - 10 V input can be activated directly.

- Analog output 1 (terminals A1 - GND)
 - Controlled 0 - 10 V output for control circuit 1 (factory setting function $\boxed{2A}$).
- Analog output 2 (terminals A2 - GND)
 - For operation with one control circuit: constant voltage +10 V e.g. for supply of an external potentiometer (function factory setting $\boxed{1A}$).
 - For operation with a second control circuit: controlled 0 - 10 V output for control circuit 2 (function initial setting $\boxed{8A}$).

Other functions can be assigned if necessary (☞ Operating Instructions / IO Setup).



Danger due to electric current

It is not permissible to connect outputs of several devices to each other!

5.6 Voltage supply for external devices (+24V, GND)

A voltage supply is integrated for external devices e.g. a sensor (max. current load ☞ technical data). In case of overload or short circuit (24 V – GND), the external power supply is shut down (multi-fuse). The device performs a "Reset" and continues operation.

- It is not permissible to connect voltage outputs of several devices to each other!
- It is not permissible to connect voltage outputs in the device to each other!

5.7 Digital inputs (D1, D2)

Various functions can be allocated to the digital inputs "D1" and "D2" (☞ IO Setup: Functions summary of the digital inputs). Activation via floating contacts (a low voltage of ca. 24 V DC is connected).



Danger due to electric current

Never apply line voltage to the digital input!

Observe input resistance and voltage range (☞ Technical data).

5.8 Relay outputs (K1, K2)

Various functions can be allocated to the relay outputs "K1" and "K2" (☞ IO Setup: function and inverting relays outputs). Max. contact rating ☞ technical data and connection diagram.

Relays K1

- Connection of the floating contacts of relay "K1" to the terminals 11, 14, 12.
- "K1 Function" factory setting: **1K** = **Operating indication**. I.e. energized for operation without fault, for enable "OFF" de-energized.

Relays K2

- Connection of the floating contacts of relay "K2" to the terminals 21, 24, 22.
- "K2 Function" factory setting: **2K** = **Fault indication**. I.e. energized for operation without fault and for enable "OFF".

5.9 RS-485 interfaces for MODBUS RTU

The device has two RS-485 interfaces for networking via MODBUS RTU:

1. Interface "1A (1D+)", "1B (1D-)" for MODBUS Master applications
 - Pre-programmed function is output from control circuit 1: **1. Control signal (2A)**
e.g. for activating speed controllers for fans or fans with integrated controller and MODBUS interface (☞ member MODBUS Master).
The programmable functions correspond to the functions for the analogue outputs described in the IO Setup.
 - Automatic addressing of members via a patented procedure.
It is no longer necessary to address each individual member manually in the network. The "ID" connection is also assigned (for more information ☞ the following chapter).
 - Integrated failsafe wiring and 150 Ω termination.
2. Interface "2A (2D+)", "2B (2D-)" for MODBUS Slave applications
 - Connection of the device to a superordinate building control system.
 - Setting of address and communication parameters ☞ Programming: Menu group MODBUS Slave.

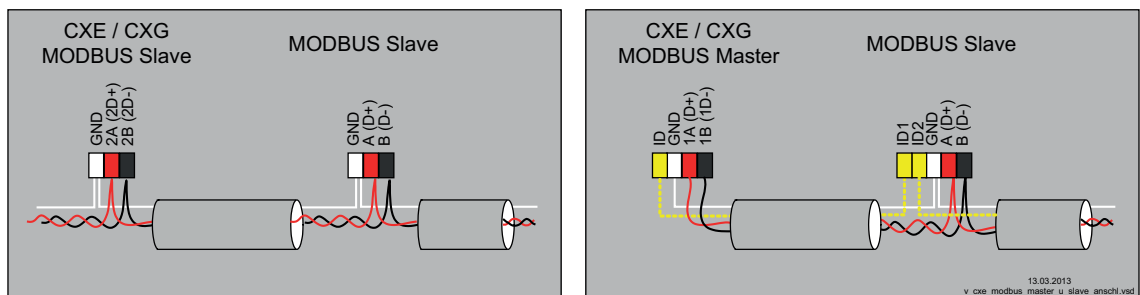

Connection MODBUS Slave and MODBUS Master interface

When using telephone flex with four cable cores, we recommend the following allocation:

- A (D+) = red
- B (D-) = black
- ID - ID1/2 = yellow (for automatic addressing for MODBUS Master)
- GND = white



Information

- You must ensure correct connection; i.e. "A (D+)" must also be connected on the following devices to "A (D+)". The same applies to "A (D+)".
- In addition, a "GND" connection must be established, as dissimilar potential (over 10 V!) will lead to the destruction of the RS-485 interface (e.g. lightning).

- Except for the data link “A (D+)”, “B (D-)”, the “ID1 - ID2” (automatic addressing for MODBUS Master) and the “GND” connection, no further cable cores of the data line may be used.
- Do not use wire shield!
- Pay attention to sufficient distance from powerlines and motor wires (min. 20 cm).

The data line must be connected from one device to the next. No other type of wiring is allowed! Always use only two wires of one lead (twisted pair) for the connection.

MODBUS connection

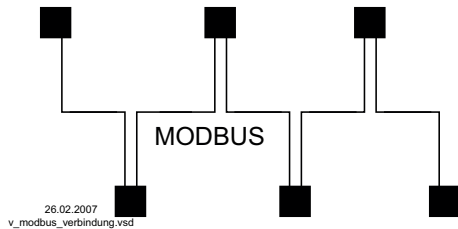

Recommended wire types

1. CAT5 / CAT7 cables
2. J-Y (St) 2x2x0.6 (telephone wire)
3. AWG22 (2x2 twisted pair)

Max. allowed wire length 1000 m (CAT5/7 500 m)



Information

If any matters are unclear, please contact our V-STE support department for control systems - ventilation technology. The information sheet "Network structure of MODBUS" R-TIL08_01 contains detailed information about "MODBUS".

5.9.1 Addressing member MODBUS Master Interface

Up to **32** members can be connected at the MODBUS Master interface.

No other components are required for the patented automatic addressing (activation  menu group MODBUS Master: AutoAddressing). Only the connections “ID1” and “ID2” of the Slave members are connected additionally next to the bus connection and at the “ID” connection of the MODBUS Master for this.

The “ID” connection of the MODBUS Master must be connected to the “ID1” or “ID2” connection of the **first Slave member**. This is recognised as a result and occupied by address **1**.

For the following users the connection “ID1” or “ID2” of a Slave user respectively is connected with connection “ID1” or “ID2” of the next Slave user.

The automatic addressing of other users is initiated by the previous user via this connection.

The individual members can be addressed in advance without this device by an external terminal or a PC.

Alternatively, the addressing can be done manually by a separate hand held terminal or PC software, the appropriate number of members must then be entered on the MODBUS Master ( menu group MODBUS Master: BUS Slavecount).



Information

- When using the automatic addressing, no repeaters can be used because these do not pass the signal through to the addressing.
- Depending on the version, the connections for MODBUS “A (D+)”, “B (D-)” are available single or double at the Slave members. These are connected with each other internally electrically.
- The connections for the automatic addressing “ID1” and “ID2” are **not directly** connected with each other internally. These may not be bridged; any order of connection is possible.
- Do not connect the cable screen! When using the connection box, the cable screen of the CAT5 cable is connected internally by an RC element to “PE”.
- The communication parameters are fixed  Programming: Menu group MODBUS Master.

Networking with telephone wire

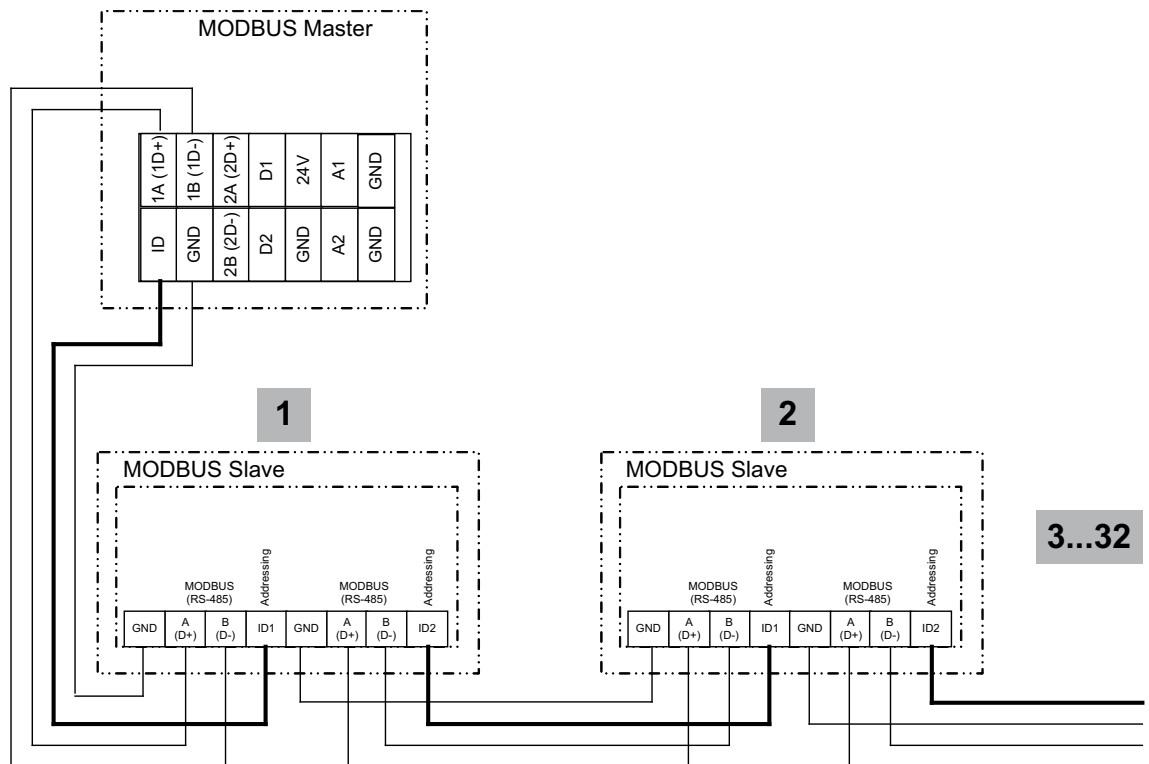

13.03.2013
v_modbus_master_autoadr.vsd

The connection at the terminal is made at the terminals: 1A (1D+), 1B (1D-) and GND
 Connection of the users via the terminals: A (D+), B (D-), GND and ID1 / ID2

Networking with RJ45 patch cable by usage connection box for ECblue (part. no. 380085).

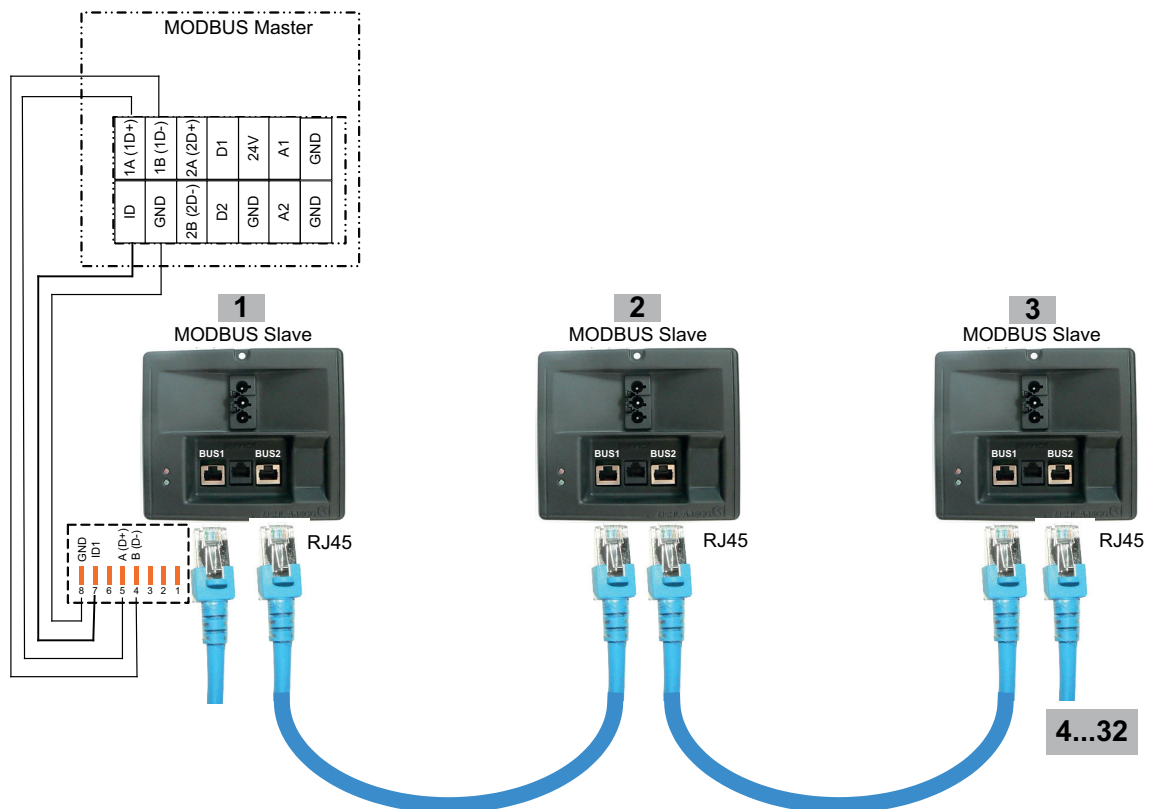

13.03.2013
v_modbus_master_autoadr_zabox.vsd

Connection to the MODBUS Master at the terminals: 1A (1D+), 1B (1D-), ID and GND
 Connection of the Slave members via the two RJ45 connections "BUS1" and "BUS2"

5.10 USB-interface

Over the USB interface if necessary a software update can be made. For this a consultation with the manufacturer is necessary.



Danger due to electric current

Plug the jumper J1 to both PINs only for a software update via USB interface. The device will not switch on if this jumper is plugged to both PINs!

Do not replug the jumper under voltage, observe the safety instructions!

5.11 Potential at control voltage connections

The control voltage connections (< 50 V) relate to the joint GND potential (Exception: Relay contacts are potential free). There is a potential separation between the control voltage connections and the protective earth. It must be ensured that the maximum external voltage at the control voltage connections cannot exceed 50 V (between "GND" terminals and "PE" protective earth). If necessary, a connection to the protective earth potential can be established, install bridge between "GND" terminal and the "PE" connection (terminal for screening).

6 Select operation mode

6.1 Mode and signal input



Information

Simple installation is possible through the selection of the preprogrammed mode of operation (☞ Start-up)

This determines the basic function of the device; factory setting **1.01** = speed controller (activation via 0 - 10 V signal). The controller configuration is automatically carried out during selection of the application related mode of operation. The factory presets in accordance with the mode of operation are based on many years of experience, which is suitable for many applications. Under special circumstances, these can be individually adapted (☞ Operating Instructions / Controller Setup: "Controller Configuration").

The purpose of the device is to reach and maintain the target values set. To accomplish this, the measured actual value (sensor value) is compared with the adjusted target value, and the controlled value (modulation) is deduced from this.

By selection of the mode the function for control circuit 1 is determined, this influences the following outputs (factory setting):

1. Analog output "A1" 0 - 10 V with function **2A** (☞ Electrical installation).
2. MODBUS Master interface "1A" + "1B" with function **2A** (☞ Electrical installation).

Mode	Signal or Sensor (input)	Function
1.01	Signal: 0 - 10 V, 0 - 20 mA, 4 - 20 mA	Speed controller with input for Setting signal, two step operation (Factory setting)
1.02	-	Manual speed controller with direct setting by the keys ▼ ▲ (0 - 100 % or in 1 - 5 steps)
2.01	* Sensor KTY81-210 / PT1000 (E1)	Temperature control airconditioning and refrigeration (preset set-point 20.0 °C, P-band 5.0 K)
2.02	* Sensor KTY81-210 / PT1000 (E1)	Temperature control depending on outdoor temperature (preset set-point 5.0 °C, - P-band 20.0 K)
2.03	Sensor KTY81-210 / PT1000 (E1)	Temperature control with additional functions (shutter and heating)
2.04	* 1x Sensor KTY81-210 / PT1000 (E1) 1x Sensor KTY81-210 / PT1000 (E2)	Temperature control with two sensors, comparison or average
2.05	* 1x Sensor KTY81-210 / PT1000 (E1) 1x Sensor KTY81-210 / PT1000 (E2)	Temperature control with two sensors differential temperature
3.01	* Sensor MBG.. (E1)	Pressure control condensers (refrigeration)
3.02	* Sensor MBG.. (E1)	Pressure control for condensers with input for refrigerant
3.03	* 1x sensor MBG.. (E1) 1x sensor MBG.. (E2)	Pressure control for two circuit condensers
3.04	* 1x sensor MBG.. (E1) 1x sensor MBG.. (E2)	Pressure control for two circuit condensers with input for refrigerant
4.01	* Sensor DSG.. / MPG.. (E1)	Pressure control for ventilation systems
4.02	1x Sensor DSG.. / MPG.. (E1) 1x Sensor KTY81-210 / PT1000 (E2)	Pressure control depending on outdoor temperature
4.03	1x Sensor DSG.. / MPG.. (E1) 1x BUS RS 485	Pressure control with outdoor temperature-dependent setpoint adaptation and activation by MODBUS
5.01	* Sensor DSG.. / MPG.. (E1)	Volume control (constant) for ventilation systems
5.02	1x Sensor DSG.. / MPG.. (E1) 1x Sensor KTY81-210 / PT1000 (E2)	Volume control with setpoint depending on outdoor temperature
6.01	* Sensor MAL.. (E1)	Air velocity control e.g. clean room

* Operation with a second control circuit possible

Mode and Signal to E1, E2

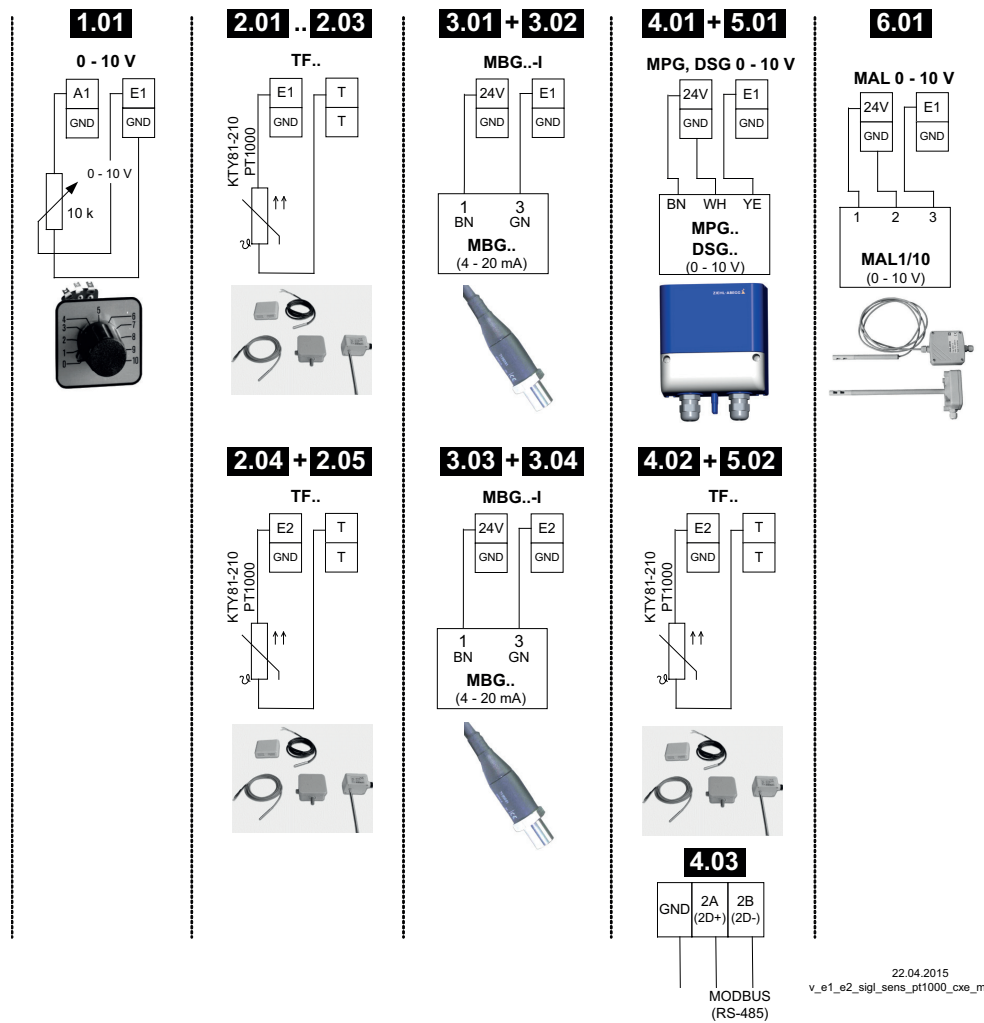

22.04.2015
v_e1_e2_sigl_sens_pt1000_cxe_master.vsd

6.2 Operation with a second control circuit

The function for control circuit 1 is determined by selection of the mode. This influences the output with function **[2A]**.

A second control circuit with separate actual value measuring and separate output can be activated additionally if required.

Control circuit 2 influences the output with function **[8A]**.

- Analog output “A2” (factory setting) IO Setup
- MODBUS Master interface member menu

Operation with a second control circuit is **not** possible in the following modes:

1.01, 1.02, 2.03, 4.02, 4.03, 5.02

The following modes which are pre-programmed to operation with a second sensor can be reprogrammed to operation with a second control circuit.

2.04, 2.05, 3.03, 3.04

The second control circuit is activated by the “E2 function” for the second analogue input “E2” (menu group “Base Setup”).

E2 functions for activating control circuit 2:

E2 Function	Description second control circuit	Factory setting	
		E2 Analog In	2.Setpoint 1
Temperature (8E)	Temperature control Presettings and sensor selection Mode 2.01	TF	20.0 °C
Cold-Pressure (9E)	Pressure control condensers Presettings and sensor selection Mode 3.01	MBG0-30	15.00 bar
Cold-Temperature (10E)	Pressure control for condensers with input for refrigerant Presettings, sensor selection and input for refrigerant Mode 3.02	MBG0-30	35.0°C
Air Pressure (11E)	Pressure control Airconditioning Presettings and sensor selection Mode 4.01	DSG200	100.0 Pa
Air flow (12E)	Air volume control Presettings, sensor selection and K-Factor for inlet ring Mode 5.01	DSG200	44720 m³h
Air speed (13E)	Air velocity control Presettings and sensor selection Mode 6.01	MAL1	0.50 m/s

When activating control circuit 2, the “Setting” menu group is extended.

- The additional parameters for control circuit 2 are identified by a prefixed “2.” e. g. “2.Setpoint 1”.
- A prefixed “1.” e. g. “1.Setpoint 1” is added to the parameters for control circuit 1.

Example:Second control circuit Pressure control condensers

E2 function = [9E], Mode 2.01 for temperature control via control circuit 1	
Setting	1.Setpoint 1
20.0 °C 1.Setpoint 1	Setpoint 1 for control circuit 1 Setting range with passive sensor type “TF”, “PT1000” : -50.0...150.0 °C Factory setting: 20.0 °C
Setting	1.Setpoint 2
----- 1.Setpoint 2	Setpoint 2 for control circuit 1 Setting “Setpoint 2” e.g. reduced value for night operation. Switch over Setpoint 1/2 by external contact (as long as no allocation is carried out Display: [-----] IOSetup).
Setting	1. Pband 1
5.0 K 1. Pband 1	Pband 1 for control circuit 1 Setting range with passive sensor type “TF”, “PT1000” : 0.0...200.0 °C Factory setting: 5.0 K
Setting	1. Min. Speed
0 % 1. Min. Speed	Minimal Speed for control circuit 1 Setting range: 0 rpm... “1. Max. Speed” Factory setting: 0 %
Setting	1. Max. Speed
100 % 1. Max. Speed	Maximal Speed for control circuit 1 Setting range: 100 %... “1. Min. Speed” Factory setting: 100 %
Setting	2.Setpoint 1
12.0 bar 2.Setpoint 1	Setpoint 2 for control circuit 2 Setting range: in measuring range of sensor Factory setting: 12,0 bar

Setting	2.Setpoint 2
----- 2.Setpoint 2	Setpoint 2 for control circuit 2 Setting "Setpoint 2" e.g. reduced value for night operation. Switch over Setpoint 1/2 by external contact (as long as no allocation is carried out: Display: [-----] IOSetup).
Setting	2. Pband 1
5.0 bar 2. Pband 1	Pband 1 for control circuit 2 Setting range: in measuring range of sensor Factory setting: 5,0 bar
Setting	2. Min. Speed
0 % 2. Min. Speed	Minimal Speed for control circuit 2 Setting range: 0. rpm... "2. Max. Speed" Factory setting: 0 %
Setting	2. Max. Speed
100 % 2. Max. Speed	Maximal Speed for control circuit 2 Setting range: 100 %... "2. Min. Speed" Factory setting: 100 %
Setting	Manual mode
OFF 1. Manual mode	Manual mode for control circuit 1 "OFF" = automatic control as function of the set parameters (Factory setting) "ON" = automatic control without function, speed setting in menu "Speed manual"
Setting	Speed manual
100 % 1. Speed man.	Speed Manual mode for control circuit 1 Setting range: 0 rpm... "1. Max. Speed" Factory setting: 100 %

Function extension for digital inputs "D1" and "D2" in operation with second control circuit

D1 / D2 Function	Description *
E1 / E2 (4D)	The output for control circuit 2 is set additionally to "A2" to "A1" (regardless of the programmed function for <u>A1</u>). Control circuit 1 has no output for the duration of the switching.
2. Setpoint 1/2 (9D)	for control circuit 2: Switch over "Setpoint 1" / "Setpoint 2"
2.Setp+Pband1/2 (16D)	for control circuit 2: Switch over Setpoint 1/2 and Pband 1/2 When programming this function, "Setting" additionally lists the parameter: "2.Pband 2 for control circuit 2."

* Detailed description IO Setup / Digital Inputs "D1" / "D2"

Following restrictions apply for the control circuit 2:

- The “Manual Mode” function in the “Setting” menu group only influences control circuit 1!
- The Limit (☞ IO Setup [3D] and Controller Setup) function influences both control circuits simultaneously.
- The “Max. Speed” setting by a digital input (☞ IO Setup [11D]) simultaneously influences both control circuits. I.e. at “1.Max. Speed” and at “2.Max. Speed”.
- The controller configurations (KP, KI, KD, TI ☞ Controller Setup) are identical for both control circuits. Fine adjustment is possible for each control circuit by the separate “Pband” setting.

6.3 External Setpoint / External speed setting in manual operation

External setpoint setting or external manual operation are possible using a 0 - 10 V (0 - 20 mA, 4 - 20 mA) signal at the “E2” and “GND” terminals. Configure “E2” in Base setup. For potentiometers, program Analog Out 1 (terminal “A1”) to the function [1A] = “+10 V” (as factory setting ☞ IO Setup). E2 Analog In = factory setting 0 - 10 V

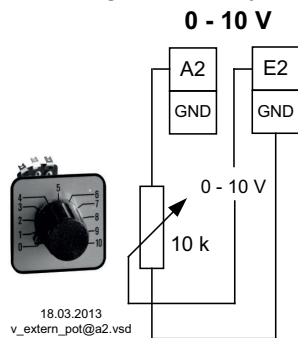

External Setpoint via external signal instead of “Setpoint 1”. The “external Setpoint” function must be activated in base setup [1E] for “E3 function”. The active external Setpoint value is displayed in the “info” menu group.

External speed setting in manual operation. The “external manual operation” function must be activated in the basic settings [2E] for “E3 function”. Switchover between settings on the device and external manual operation via the digital input (☞ IO Setup: “Control / manual operation” [7D]).

Not possible in modes with 2 sensors and operation with a second control circuit because the second analogue input is already occupied by it.

7 Start-up

7.1 Prerequisites for commissioning



Attention!

1. You must mount and connect the device in accordance with the operating instructions.
2. Double check that all connections are correct.
3. The mains voltage must match the information on the rating plate.
4. Make sure that no persons or objects are in the fan's hazardous area.

7.2 Procedure for commissioning

1. Turn on mains voltage
 - Display:

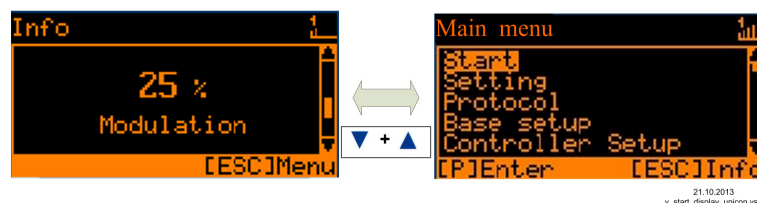

(Function of display ☞ controls and menu)

2. Switch over between “Info” and “Main menu” with the “Esc” key combination
3. Menu group: **Start**

- Set the menu language if necessary (factory setting English = Language GB).
- The display can be switched between SI units (US units = OFF) and imperial (US) units (US units = ON).
- 4. Menu group: **Base setup**
 - Set the desired mode (factory setting **1.01** = speed controller).
 - Further settings depend on the selected mode and the sensor / setting signal used.
- 5. Menu group: **Setting**
 - Set the parameters for the control mode.

Excerpt from the menu table

Start									
Language	GB	GB	GB	GB	GB	GB	GB	GB	GB
US units	OFF	OFF	OFF	OFF	OFF	OFF	OFF	OFF	OFF
Base setup									
Mode	1.01 1.02	2.01 2.03 2.04	2.02	2.05	3.01 3.02	3.03 3.04	4.01 4.02 4.03	5.01 5.02	6.01
E1 Analog In	1.01 = 0 - 10 V	TF	TF	TF	0-30 MBG	0-30 MBG	DSG200	4.01 = DSG200 4.02 + 4.03 = DSG50	0-1 MAL
Number steps	1.02 = 0								
Step 1 value	1.02 = -- -- (20%)								
E1 Refrigerant					3.02 = R503	3.04 = R503			
E1 K-Factor								75	
E2 Refrigerant						3.04 = R503			
Setting									
Set Intern1	1.01 = 80%								
Setting direct	1.02 = 80%								
Setting Step	1.02 = 0								
Setpoint1		20.0 °C	5.0 °C	0.0 °C	12.0 bar 35.0°C	12.0 bar 35.0°C	100 Pa	530 m ³ h	0.50 m/s
Pband 1		5.0 K	20.0 K	5.0 K	5.0 bar 7.0 K	5.0 bar 7.0 K	100 Pa	530 m ³ h	0.50 m/s
Set external1	1.01 = ON								



Information

Adjust further settings according to the desired function (☞ Operating Instructions / Programming)

8 Controls and Menu

8.1 Multipurpose LC display and keyboard

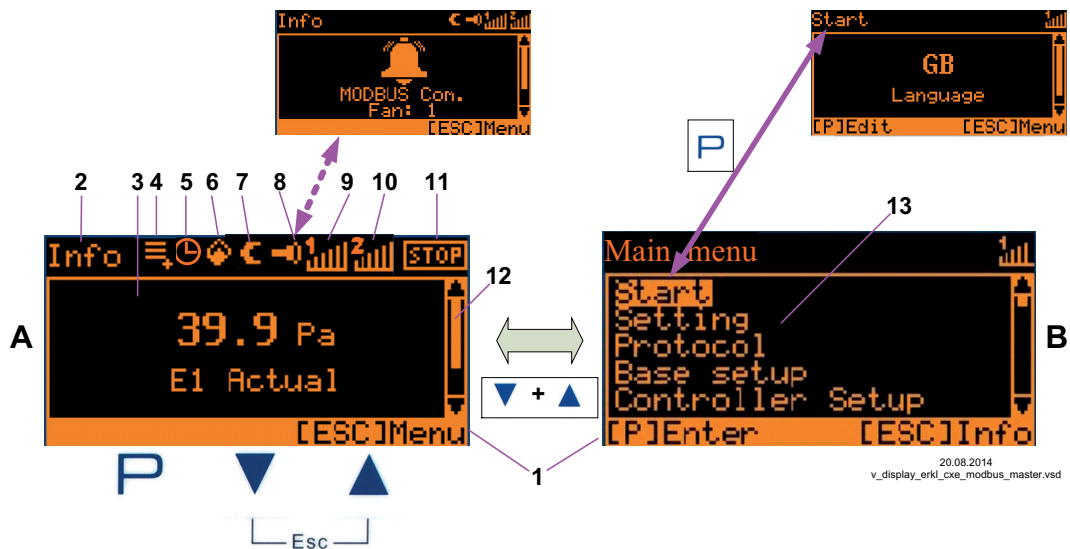

<p>A</p>	<p>Actual value display Display after line voltage is switched on or after the Esc key combination is used to exit the settings menu (display depends on selected mode and sensor value).</p>	<ol style="list-style-type: none"> 1. Status bar 2. Display of the menu group in which the displayed menu is located 3. Display window 4. Log entry which still was not seen 5. Timer function active 6. Fire-Symbol (heating operation) 7. Moon-Symbol for set point 2 8. Alarm symbol (fault message alternating with actual value display) 9. Modulation control circuit 1 10. Modulation control circuit 2 (if activated) 11. STOP-Symbol (enable) 12. Position of the menu in the menu group 13. List of the menu groups
<p>B</p>	<p>Main menu Display after the Esc key combination is used to exit the actual value display. Select the desired menu group with the ▼▲ buttons and use the P-key to open it.</p>	
<p>P</p>	<p>Program key and open menu.</p>	
<p>▼</p>	<p>Menu selection, reduce value.</p>	
<p>▲</p>	<p>Menu selection, increase value.</p>	
<p>▼ + ▲ Esc</p>	<p>Esc-key combination, Escape = leave menu. Switch between Info and Main menu.</p>	

8.2 Menu operation

Info	<p>Display after turning on the mains voltage description for menu language English = "GB" (delivery status). Switch over between "Info" * and "Main menu" with the Esc key combination.</p> <p>Example for mode 1.01 (speed controller).</p> <p>*Info depending on device type: - "Speed" / rpm,- "Frequency" / Hz, - "Modulation" / %</p>	Main menu
<p>0 % Modulation</p>		<p>Start</p> <p>Setting</p> <p>Protocol</p> <p>Base setup</p> <p>Controller Setup</p>
[ESC] Menu		[P] Enter

Main menu	<p>Select the desired menu group with the ▼▲ keys (text highlighted) and open with the P-key.</p>
<p>Start</p> <p>Setting</p> <p>Protocol</p> <p>Base setup</p> <p>Controller Setup</p>	
[P] Enter	

▲ ▼

Start	<p>PIN input, e.g. for resetting to basic factory setting</p>
<p>----- PIN input</p>	
[P] Edit	

▲ ▼

Start	<p>In the menu point "Language" display language can be selected. One returns to the menu group "Start" using the Esc (▼ + ▲) shortcut keys.</p>
<p>GB Language</p>	
[P] Edit	

8.3 Example for programming mode **2.01** in "Base setup "

Sequence

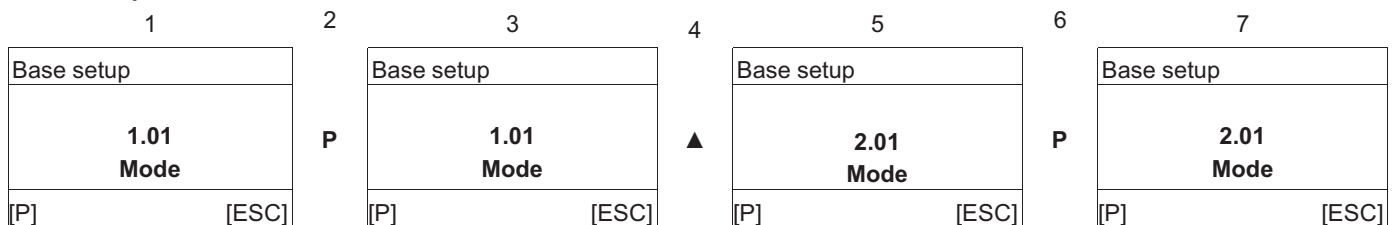

8.4 Menu structure

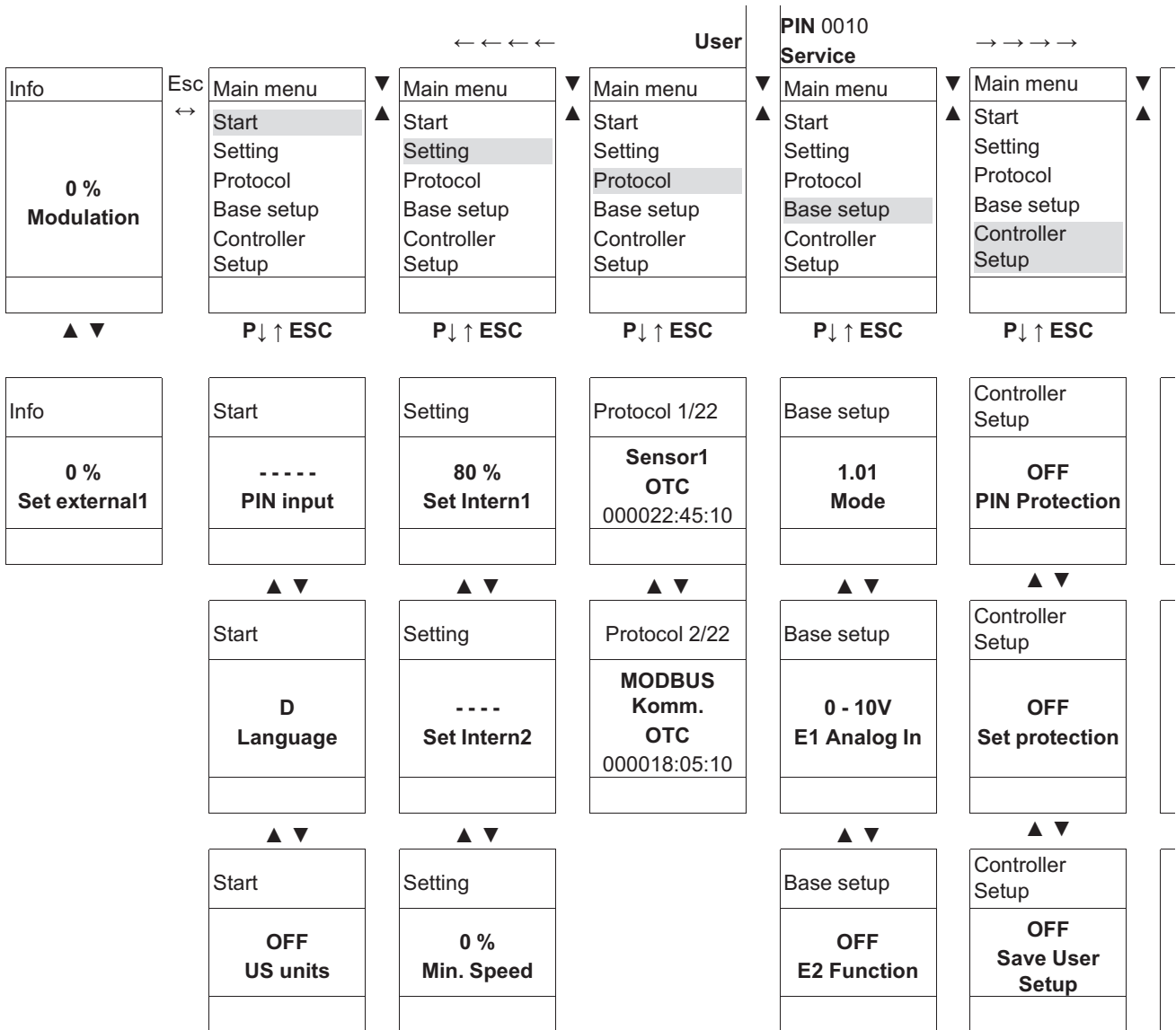

Menu dependent on mode

Selection of the menu group (e.g. Base setup) to the right through the ▼-key, to the left through the ▲-key. You can go to the menu items in the menu groups (e.g. mode of operation) by using the P key. Use the arrow keys to move up and down within the menu group. The menu groups consist of one area for the user (user menu) and one area for installation (service). The service area can be protected against unauthorized access by using a PIN. In order to simplify the initial start-up operation, the service level is enabled at first (i.e., not protected by the PIN 0010 (☞ Operating Instructions / Controller Setup, PIN protection = OFF). If PIN protection is activated (ON), the service menu remains enabled after input of PIN 0010 as long as one is pressing keys. If no keys are pressed for ca. 15 minutes, the PIN is automatically erased, i.e. the service level is blocked. To make adjustments, press the P key after selecting the menu item. If the previously set value starts to ash, it can be adjusted with the ▼ + ▲ keys and then saved with the P key. To exit the menu without making any changes, use the “Esc” short-key, i.e., the originally set values remain.



Information

After installation of the device has been carried out, PIN protection should be activated (☞ Operating Instructions / Controller Setup)!

8.5 Overview menu groups

Main menu	Possible settings
Info	Display measured actual values, selected setpoints, modulation, etc. Settings cannot be made in this menu group.
Start	PIN input for reset to initial settings and to protect settings. Setting the menu language. Display in SI units or Imperial units (US) Complete re-start of the device. Display of the set mode, software version, etc.
Setting	Settings for Operation, Setpoint, Pband, Min. Speed, Max. Speed, etc.
Protocol	Display and query of events / malfunctions.
Base setup	Setting of the desired mode, configuration of signal and sensor inputs. Activation control circuit 2.
Controller Setup	Activate set protection, save user settings. Activate alarm message in the event of a sensor fault. Activate limitation of modulation via digital input or timer of time switch. Configuration of control parameters, group control.
IO Setup	Configuration and function assignment for: analogue outputs, digital inputs, relay outputs. Function MODBUS interface: COM2 for MODBUS Slave or MODEM SMS.
Limits	Limit messages depending on modulation, setting signal or sensor signal, offset to setpoint.
Timer	Integrated time switch with programmable timer functions. Clock fine adjustment
Diagnostic	Current operating states of the device.
MODBUS Slave MODBUS SMS	Addressing and configuration of the MODBUS Slave interface. alternatively Input of SIM PIN for MODBUS SMS interface (currently no function).
MODBUS Master	Start automatic addressing of members. alternatively Manual input of number of members.

9 Programming



Display in SI units or Imperial units (US)

The following description is for display in SI units (factory setting). The appropriate conversion factors must be observed when switching over to Imperial units (US) (☞ menu group Start / US Units).

9.1 Speed controller **1.01**, **1.02**

9.1.1 Speed controller with setting by external signal **1.01**

Settings for controller output with function **2A** (by analogue signal ☞ IO Setup, by MODBUS ☞ members menu).

Base setup **1.01**

Main menu	Base setup
Setting	
Protocol	
Base setup	
Controller Setup	
IO Setup	
Base setup	Mode
1.01 Mode	Factory setting Mode: 1.01
Base setup	E1 Analog In
0 - 10V E1 Analog In	Selection: 0 - 10V, 0 - 20 mA, 4 - 20 mA (Inverting, E1 BUS Modus ☞ IO Setup) Factory setting: 0 - 10 V
Base setup	E2 Function (only for special applications)
OFF E2 Function	Analog input 2 "E2" factory set at "OFF". For operation with a second setting signal and switch over by potential-free contact: E2 Function = Ext. Setpoint (1E) Necessary function for digital input: E1/E2 (4D) ☞ IO Setup For operation with a second signal and automatic control at the higher level: E2 Function = comparison E1 (4E).
Base setup	E2 Analog In
----- E2 Analog In	Display as long as no function allocated: ----- Selection: 0 - 10 V, 0 - 20 mA, 4 - 20 mA (Inverting, E2 BUS Modus ☞ IO Setup) Factory setting: 0 - 10 V

Setting for operation 1.01

Main menu	Setting
Setting	
Protocol	
Base setup	
Controller Setup	
IO Setup	
Setting	Set Intern1
80 % Set Intern1	Setting range manual speed setting: 0...100 % Δ "Min. Speed"... "Max. Speed" Factory setting: 80 %
Setting	Set Intern2
----- Set Intern2	Setting "Set Intern2" e.g. reduced value for night operation. Switch over Intern1 1/2 over external contact (display where no allocation: <input type="text" value="-----"/> ) IO Setup).
Setting	Min. Speed
0 % Min. Speed	Setting range: 0... "Max. Speed" Factory setting: 0 %
Setting	Max. Speed
100 % Max. Speed	Setting range: 100 %... "Min. Speed" Factory setting: 100 %
Setting	Set external1
ON Set external1	"ON" (factory setting) = speed setting by external Signal "OFF" = Setting "Set Intern1"

Diagram setting signal and output voltage (Idealized principle diagram)



MODBUS Out: speed setting over MODBUS
 Analog Out: speed setting over analog output 0 - 10 V
 Si Signal

9.1.2 Speed controller with direct setting by keyboard **1.02**

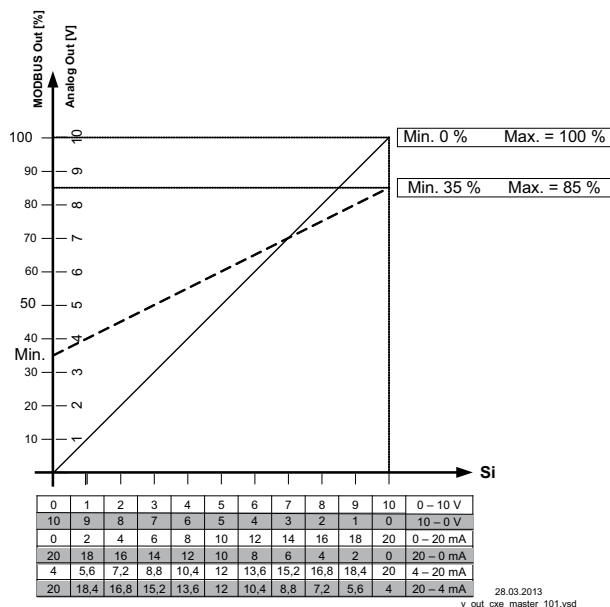
Base setup 1.02

Main menu	Base setup
Setting	
Protocol	
Base setup	
Controller Setup	
IO Setup	
Base setup	Mode Mode selection: 1.02
1.02 Mode	
Base setup	Number steps Selection: 0, 1, 2, 3, 4, 5 Factory setting: 0 Number steps: 0 In the factory setting "0" (without steps) the modulation can be set directly with the ▼ ▲ keys (☞ setting in operation). Number steps: 1, 2, 3, 4, 5 The modulation value can be assigned to each step. The desired step is set with the ▼ ▲ keys (☞ setting in operation). The following menus become active depending on the selected step count. (Step not active = [---])
0 Number steps	
Base setup	Step 1 value - 5 Setting range: 0...100 %. Factory setting: - - - - (Number steps 0) Factory setting: 20 %, 40 %, 50 %, 60 %, 100 % (Number steps 1 - 5)
----- Step 1 value	

Menu group "Setting" (only when needed)

Main menu	Setting
Setting	
Protocol	
Base setup	
Controller Setup	
IO Setup	
Setting	Setting direct (at Number steps: 0 ☞ "Base setup") If the setting is to be made during operation directly with the ▼ ▲ keys, no setting is necessary here (☞ setting in operation 1.02). Setting range: Min. Speed - Max. Speed Factory setting: 80 %
80 % Setting direct	
Setting	Setting step (at Number steps: 1 - 5 ☞ "Base setup") If the setting is to be made during operation directly with the ▼ ▲ keys, no setting is necessary here (☞ setting in operation 1.02). Setting range: 0 - setting nummber steps Factory setting: 0
0 Setting Step	

Setting	Min. Speed
0 % Min. Speed	Setting range: 0... "Max. Speed" Factory setting: 0 %
Setting	Max. Speed
100 % Max. Speed	Setting range: 100 % - "Min. Speed" Factory setting: 100 %

Setting in operation 1.02

After installation is completed, only the "Setting direct" or "Setting Step" setting is visible in the "Info" menu group. All other menus are protected by a PIN.

Info	Setting direct (at Number steps: 0 ↻ "Base setup")
76 % Setting direct	Setting range: Min. Speed - Max. Speed Factory setting: 80 %
	The value set by the ▼ ▲ keys is accepted and executed directly (P key without function).
Info	Setting step (at Number steps: 1 - 5 ↻ "Base setup")
5 Setting Step	Setting range: 0 - programmed number steps Factory setting: 0

Switching over to the protected "Info" menu group takes place automatically after approximately 15 minutes if no key is pressed.

Possibilities for early activation of PIN protection:

- Select the "Info" menu group and confirm with the P key.
- Press the [Esc] key combination several times until the "Setting direct" or "Setting Step" menu is displayed.
- Execute the "Reset" function in the "Start" menu group.
- By switching the mains voltage off and then on again.

Input PIN [0010] to exit the protected area

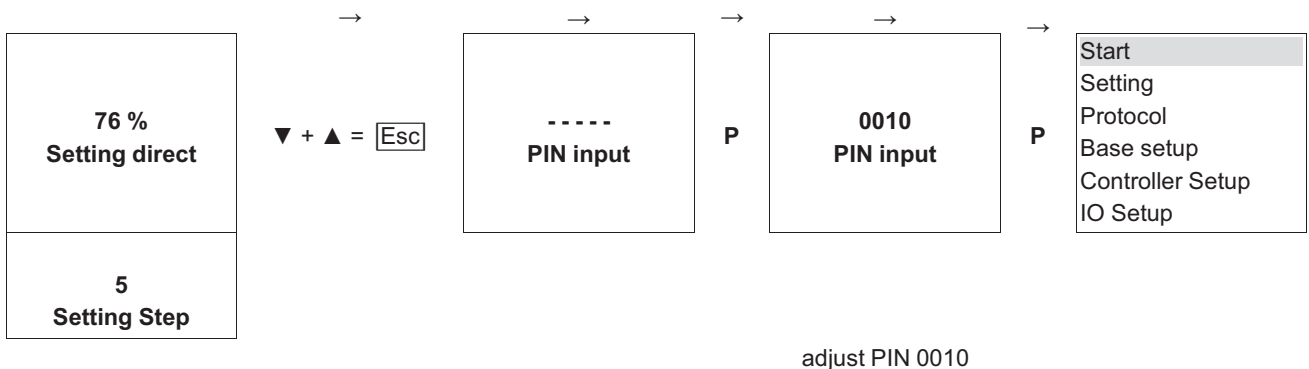

9.2 Temperature control **2.01...2.05**

9.2.1 Basic setting **2.01... 2.05**

Main menu	Base setup
Setting	
Protocol	
Base setup	
Controller Setup	
IO Setup	
Base setup	Mode
2.01	Mode selection e.g. 2.01
Mode	
Base setup	E1 Analog In
TF	The sensor input is factory set in modes of group 2 to sensors of the "TF" type series (sensor type KTY81-210).
E1 Analog In	Measuring range: -50.0...+150 °C Connection terminals: "GW E1 Viive" and "T"
	Other settable sensors:
	<ul style="list-style-type: none"> • PT1000 at terminals "E1" and "T", (measuring range -50.0...+150 °C) • MTG-120V (type designation for active sensor with 0 - 10 V output, connection to terminals "E1", "GND" and "24 V", measuring range: -10...+120 °C) • 0 - 10 V, 0 - 20 mA, 4 - 20 mA (for sensors with free measuring range and linear characteristic)
	The sensor measuring range must be entered for sensors with free measuring range in order to display the actual value correctly. Example with a 0 - 10 V sensor and 0 - 100 °C measurement range: E1 Analog In = 0 - 10 V, E1 Unit = °C, E1 Decimals = 1, E1 Min. = 0,0 °C, E1 Max. = 100,0 °C, When selecting sensors with active signal, the setpoint and the Pband are automatically set to the 1/2 measuring range.
Base setup	E1 Offset
20.0 °C	Sensor calibration with calibrated comparison device.
E1 Offset	The current "E1 Actual" is displayed including the offset set here.

Base setup	E2 Function
OFF E2 Function	<p>The second signal input is not activated at the factory for modes with one sensor. The function is automatically jointly programmed in operating modes using two sensors. The second analog input is thus allocated and additional function allocations are not possible.</p> <ul style="list-style-type: none"> • 2.04 E2 Function at 4E preprogrammed = comparison value with control to higher temperature. Alternative: average of 2 measuring points for this must be reprogrammed on function 3E preprogrammed sensor type "TF". • 2.05 E2 Function at 5E preprogrammed = regulation on difference temperature between sensor 1 and sensor 2. Preprogrammed sensor type "TF". <p>Adjustable "E2 Function"</p> <ul style="list-style-type: none"> • 1E = External Setpoint e.g. via external signal (0 - 10 V) instead of "Setpoint 1" <ul style="list-style-type: none"> – For sensor type "E1 Analog In" = "TF or PT1000": 0 - 10 V $\hat{=}$ -50.0...+150 °C. – For sensors with active signal: 0 - 10 V $\hat{=}$ 0 - 100 % sensor measuring range. • 2E = External manual operation via external signal (0 - 10 V). Switch over between settings on the device and external manual operation via digital input (☞ IO Setup: function 7D). • 6E = sensor for outdoor temperature-dependent setpoint adaptation (at 2.03 not possible), pre-programmed sensor type "TF..". <ul style="list-style-type: none"> – additional parameters menu group "Setting": T-Band, T-Start SA, Min. Setpoint. – additional parameters menu group "Info": Setpoint Control – Example ☞ Setting for operation 4.01... 4.03 / additional menu items. • 7E = Measurement value = Measurement value e.g. for limit indication, display in Info menu "E2 Actual". • 8E... 13E = sensor input for control circuit 2 (at 2.03 not possible) ☞ base setup / operation with second control circuit.

9.2.2 Settings for operation modes 2.01... 2.05

- 2.01** Temperature control airconditioning and refrigeration (preset set-point 20.0 °C, P-band 5.0 K)
- 2.02** Temperature control depending on outdoor temperature (preset set-point 5.0 °C, - P-band 20.0 K)
- 2.03** Temperature control with pre-programmed additional functions (heating, shutter, temperature monitoring).
- 2.04** Temperature control with 2 sensors
Comparison with control to higher value "E2 Function" set to comparison **4E**. Display during operation: "Control value"
Alternative: Average calculation of 2 measuring places "E2 Function" set to **3E**. Display during operation: "Average E1 / E2"
- 2.05** Temperature control with 2 sensors, regulation on difference temperature.
Display during operation: "Value of E1 - E2" in K, "E1" = reference temperatur, "E2" causes positiv (E2 < E1) or negative (E2 >E 1) difference.

Settings for controller output with function **2A** (by analogue signal ☞ IO Setup, by MODBUS ☞ members menu).

Main menu	Setting
Setting	
Protocol	
Base setup	
Controller Setup	
IO Setup	

Setting	Setpoint1
20.0 °C Setpoint1	Setting range with passive sensor type "TF", "PT1000": -50.0...150.0 °C Factory setting: 2.01 , 2.03 , 2.04 : 20.0 °C at 2.02 : 5.0 °C at 2.05 : 0.0 °C
	Setting range with passive sensor type "MTG-120V": -10.0 °C...+120.0 °C Factory setting 2.01 - 2.05 : 55.0 °C
Setting	Setpoint2
----- Setpoint2	Setting "Setpoint 2" e.g. reduced value for night operation. Switch over Setpoint 1/2 by external contact (display as long as no allocation is carried out: <input type="checkbox"/> IO Setup).
Setting	Pband
5.0 K Pband	Narrow control range = Short control times Wide control range = Longer control times and more stable control
	Passive sensor type "TF", "PT1000" Setting range: 0 - 200.0 K (Kelvin) Factory setting: 5.0 K, (at 2.02 : 20.0 K)
	active Sensor type "MTG-120V" Setting range: -120.0...+120.0 K Factory setting: 65.0 K
Setting	Min. Speed
0 % Min. Speed	Setting range: 0... "Max. Speed" Factory setting: 0 %
Setting	Max. Speed
100 % Max. Speed	Setting range: 100 %... "Min. Speed" Factory setting: 100 %
Setting	Manual mode
OFF Manual mode	"OFF" = automatic control as function of the set parameters (Factory setting) "ON" = automatic control without function, speed setting in menu "Speed manual"
Setting	Speed manual
100 % Speed manual	Manual speed setting without influence by the external signal. Activation by menu "Manual mode" or external contact at digital input (<input type="checkbox"/> IO Setup). Setting range: 0...100 % Δ "Min. Speed"... "Max. Speed" Factory setting: 100 %
	For information about deactivated regulation the adjusted value for manual speed is indicated alternating with the actual value.

9.2.3 Functional diagrams temperature control

Example 1: Temperature control in factory setting “Cooling function” (Idealized principle diagram)

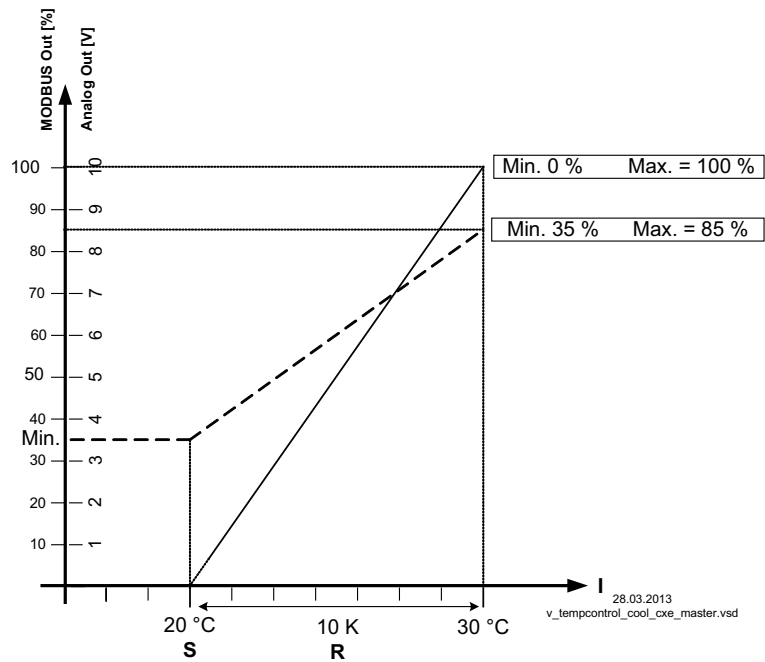

(Controller Setup: “Actual>Nominal=n+” at “ON”)
 MODBUS Out: speed setting over MODBUS
 Analog Out: speed setting over analog output 0 - 10 V
 S Setpoint
 R Pband
 I Actual value

Example 2: Temperature control in “Heating function” (Idealized principle diagram)

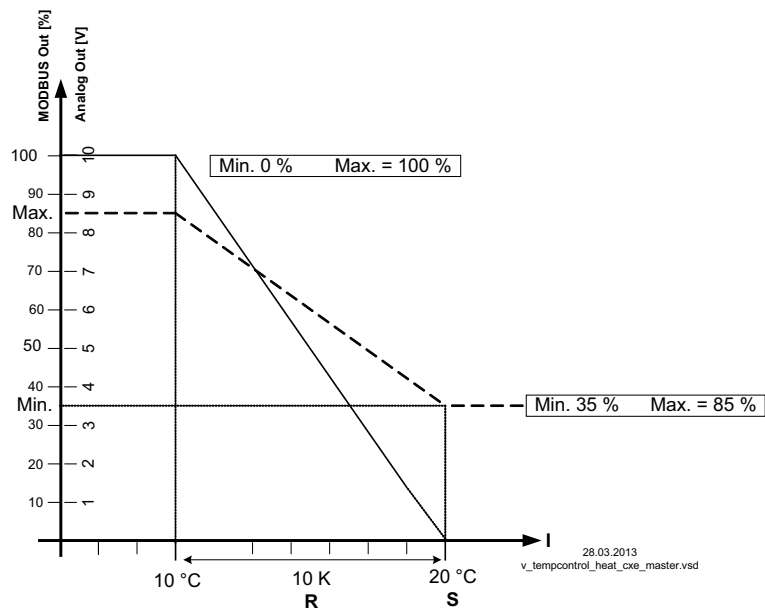

(Controller Setup: “Val>Set=n+” to “OFF”)
 MODBUS Out: speed setting over MODBUS
 Analog Out: speed setting over analog output 0 - 10 V
 S Setpoint
 R Pband
 I Actual value

9.2.4 Additionally for **2.03** (controller output 2 with function **6A**)

The 0 - 10 V output signal A2 can, e.g., be used for triggering a shutter or heating.

Setting	Offset AnalogOut
0.0 K Offset AnalogOut	The target value for this output is the target value (Setpoint) for the ventilation "offset" setting. Adjustment: range +/- 10,0 K relative to the active Setpoint. Example for triggering a shutter servomotor: At factory setting "0,0 K" = synchronous operation. The analog output is factory set to increasing activation during increasing temperature. Reprogramming to "Heating function", i.e., increasing modulation during decreasing temperature is possible (IO Setup).
Setting	Pband AnalogOut
2.0 K Pband AnalogOut	Pband AnalogOut = separately adjustable range of control (P-band) for 0 - 10 V output Setting range: 0...200.0 K Factory setting: 2.0 K
Setting	Min. AnalogOut
0 % Min. AnalogOut	Min. AnalogOut = Minimal output voltage Setting range: 0...100 % = 0 - 10 V Factory setting: 0 %
Setting	Max. AnalogOut
100 % Max. AnalogOut	Max. AnalogOut = Maximal output voltage Setting range: 100...0 % = 10 - 0 V Factory setting: 100 %

Example for signal out 0 - 10 V (IO Setup: "A2 function" = **6A**)

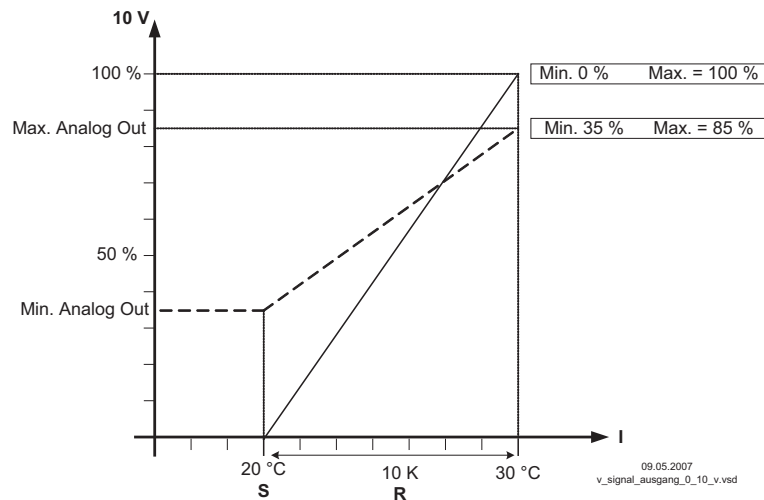

Example: Setpoint ventilation 25.0°C, Offset -5.0 K, Pband 10.0 K

S Setpoint Ventilation +/- Offset

R Pband

I Actual value

9.2.5 For mode **2.03**: Relay output for Heating or Cooling

Setting	OffsetDigitalOut
-1.0 K OffsetDigitalOut	Offset Digital Out = Offset for relay output ("K2" is pre-programmed by the factory). The relay operating point deviates by the adjusted offset of the Setpoint of the ventilation (if relay "K2" not inverted, terminal "21"- "24" bridged). Setting range: -10.0...+10.0 K Factory setting: -1.0 K <ul style="list-style-type: none"> • "0.0 K" set, i.e. heating "ON" when: actual value = Setpoint • During negative offset value heating "ON" when: actual value = Setpoint - offset • During positive offset value heating "ON" when: actual value = Setpoint + offset
Setting	Hyst.DigitalOut
1.0 K Hyst.DigitalOut	Switching hysteresis of the relay Setting range: 0...10,0 K, Factory setting: 1.0 K (Kelvin)

Temperature variation with factory setting [9K] in IO Setup e. g. for controlling a Heating.

If the ambient temperature is lower than the set operating point, the heating remains switched on. If the ambient temperature exceeds the set operating point of the heating by 2 K (Kelvin), the heating is switched off. I.e., the release point is situated at the hysteresis value over the operating point.

Example:

Setpoint 15.0 °C, Offset +5.0 K, Hysteresis 2.0 K

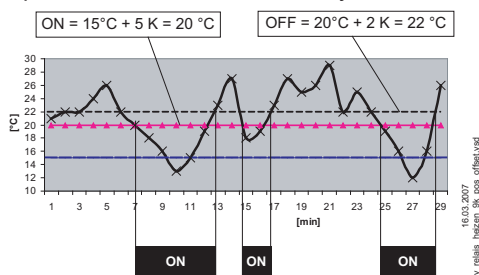

Example:

Setpoint 20.0 °C, Offset -5.0 K, Hysteresis 2.0 K

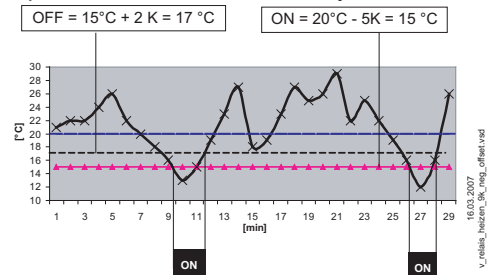

Info		
28.7 °C E1 Actual		The activated heating is indicated over the fire symbol in the display.

Temperature variation with reprogramming to [10K] for "K2" in IO Setup, e.g., for activation of the Cooling

Example:

Setpoint 15.0 °C, Offset +5.0 K, Hysteresis 2.0 K

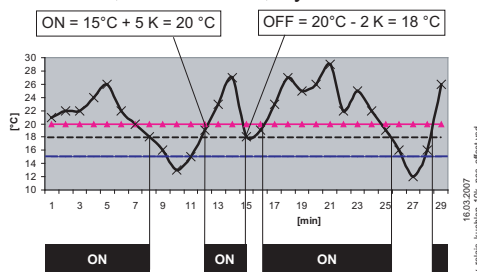



If the ambient temperature is higher than the set operating point, the cooling remains switched on. If the ambient temperature falls below the set operating point of the cooling by 2 K (Kelvin), it is switched off. I.e., the OFF point is situated at the hysteresis value under the ON point.

9.2.6 For mode 2.03 Relay output for temperature monitoring

If the set value for the “minimum alarm” is not reached or the set value for the “maximum alarm” is exceeded, a message is generated via the alarm symbol in the display. In addition, „Lmt E1 min“ is displayed alternately with the actual value for the minimum alarm and Lmt E1 max for the „Maximum alarm“. An external message follows via the factory-assigned “K1” relay. (IO Setup: K1 function = 2K).

Setting	Alarm Minimum
0.0 °C Alarm Minimum	Setting range: OFF / -49.9...150.0 °C Factory setting: 0.0 °C
Setting	Alarm Maximum
40.0 °C Alarm Maximum	Setting range: OFF / -49.9...150.0 °C Factory setting: 40.0 °C

Info	Example for display if falling below setting “Alarm Minimum” alternating to the actual value display. Relay “K1” disengages (if not inverted).
 Lmt E1 min	
Info	Example for display if exceeding setting “Alarm Maximum” alternating to the actual value display Relay “K1” disengages (if not inverted).
 Lmt E1 max.	

9.3 Pressure control for condensers refrigeration **3.01...3.04**

9.3.1 Base setup **3.01... 3.04**

Main menu	Base setup
Start	
Setting	
Protocol	
Base setup	
Controller Setup	
Base setup	Mode
3.01	Mode selection e.g. 3.01
Mode	
Base setup	E1 Analog In
MBG0-30	The sensor input is factory set for modes of group 3 to sensor type "MBG-30I".
E1 Analog In	Measuring range: 0...30 bar Output signal: 4 - 20 mA Connection terminals: "E1", "24V"
	Other settable sensors:
	<ul style="list-style-type: none"> • MBG-50I (measuring range 0...50 bar, output signal 4 - 20 mA) • DSF2-25 (measuring range 2...25 bar, output signal 4 - 20 mA) • 0 - 10 V, 0 - 20 mA, 4 - 20 mA (for sensors with free measuring range and linear characteristic)
	The sensor measuring range must be entered for sensors with free measuring range in order to display the actual value correctly. Example 0 - 10 V sensor and measuring range 0 - 20 bar: E1 Analog In = 0 - 10 V, E1 Unit = bar, E1 Decimals = 1, E1 Min. = 0,0 bar, E1 Max. = 20,0 bar
Base setup	E1 Offset
0.00 bar	Sensor calibration with calibrated comparison device.
E1 Offset	The current "E1 Actual" is displayed including the offset set here.
Base setup	E1 Refrigerant
R503	With 3.02 and 3.04 operating modes with input of the refrigerant, the device automatically calculates the corresponding temperature for the measured pressure. The settings for offset, target value and the controlling range are then carried out in °C or K.
E1 Refrigerant	Calculation for relative pressure (differential measurement of pressure relative to ambient pressure). No further settings are necessary for pressure sensors model e.g. "MBG-30I" or "MBG-50I" (measurement range 0 - 30 bar or 0 - 50 bar). In the case of sensors with other measurement ranges, the "E1 Min. value" and the "E1 Max. Value". Setting in "bar" although unit display is in "°C"!

Base setup	E2 Function
OFF E2 Function	The second signal input is not activated at the factory for modes with one sensor. The function is automatically jointly programmed in operating modes using 2 sensors. The second analog input is thus allocated and additional function allocations are not possible.
	<p>Modes with two sensors</p> <ul style="list-style-type: none"> • 3.03 and 3.04 E2 Function at 4E preprogrammed = comparison value with control to higher value (two circuit condensers). <p>Adjustable “E2 Function”</p> <ul style="list-style-type: none"> • 1E = external setpoint e.g. by external signal (0 - 10 V) instead of setting “Setpoint 1”. 0 - 10 V $\hat{=}$ 0 - 100 % sensor measuring range. • 2E = External manual operation via external signal (0 - 10 V). Switch over between settings on the device and external manual operation via digital input (☞ IO Setup: function 7D). • 3E = Sensor average to E1 • 5E = Sensor difference to E1 • 6E = sensor for outdoor temperature-dependent setpoint adaptation, pre-programmed sensor type “TF..”. <ul style="list-style-type: none"> – Menu group “Setting” additional parameter: T-Band, T-Start SA, Min. Setpoint. – Menu group “Info” additional parameter: Setpoint control – Example ☞ Setting for operation 4.01... 4.03 / additional menu items. • 7E = Measurement value = Measurement value e.g. for limit indication, display in Info menu “E2 Actual”. • 8E... 13E = sensor input for control circuit 2 ☞ base setup / operation with second control circuit.

Selection of the refrigerants:								
R12	R13	R13b1	R22	R23	R32	R114	R134a	R142B
R227	R401	R401A	R401B	R402	R402A	R402B	R404A	R407A
R407B	R407C	R410A	R500	R502	R503	R507	R717	

9.3.2 Setting for operation modes 3.01... 3.04

- 3.01** Pressure control condensers, setting Setpoint in bar
- 3.02** Pressure control for condensers with input for refrigerant, Setpoint in °C
- 3.03** Two sensors for dual circuit condenser. Automatic regulation to the highest pressure (selection amplifier integrated) operation display: “Control value”, Setpoint in bar
- 3.04** Two sensors for dual circuit condenser with input for refrigerant automatic regulation to the highest pressure (selection amplifier). Setpoint in °C , also for different refrigerants suitably there comparison of the temperatures. Display during operation: “Control value ”

Settings for controller output with function **2A** (by analogue signal ☞ IO Setup, by MODBUS ☞ members menu).

Main menu	Setting
Start	
Setting	
Protocol	
Base setup	
Controller Setup	
Setting	Setpoint1
12.0 bar Setpoint1	<p>3.01 and 3.03</p> <p>Setting range: in measuring range of sensor Factory setting: 12.0 bar</p>
	<p>3.02 and 3.04</p> <p>Setting range: dependent on the selected refrigerant Factory setting: 35.0 °C</p>

Setting	Setpoint2
----- Setpoint2	Setting "Setpoint 2" e.g. reduced value for night operation. Switch over Setpoint 1/2 by external contact (display as long as no allocation is carried out: <input type="checkbox"/> IO Setup).
Setting	Pband
5.00 bar Pband	Narrow control range = Short control times Wide control range = Longer control times and more stable control 3.01 and 3.03
	Setting range: in measuring range of sensor Factory setting: 5.0 bar 3.02 and 3.04 Setting range: dependent on the selected refrigerant Factory setting: 7.0 K
Setting	Min. Speed
0 % Min. Speed	Setting range: 0... "Max. Speed" Factory setting: 0 %
Setting	Max. Speed
100 % Max. Speed	Setting range: 100 %... "Min. Speed" Factory setting: 100 %
Setting	Manual mode
OFF Manual mode	"OFF" = automatic control as function of the set parameters (Factory setting) "ON" = automatic control without function, speed setting in menu "Speed manual"
Setting	Speed manual
100 % Speed manual	Manual speed setting without influence by the external signal. Activation by menu "Manual mode" or external contact at digital input (☞ IO Setup). Setting range: 0...100 % $\hat{=}$ "Min. Speed"... "Max. Speed" Factory setting: 100 %
	For information about deactivated regulation the adjusted value for manual speed is indicated alternating with the actual value.

9.3.3 Functional diagrams pressure control condensers

Functional diagram for Mode **3.01** and **3.03** (Idealized principle diagram)

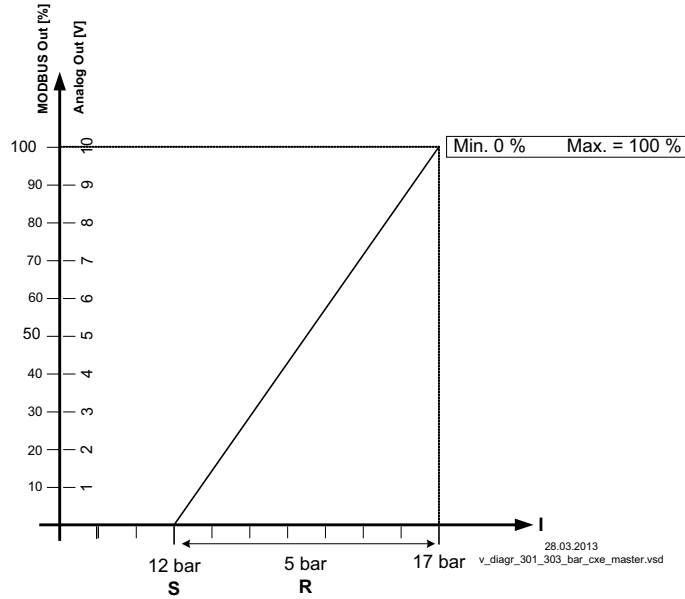

MODBUS Out: speed setting over MODBUS
 Analog Out: speed setting over analog output 0 - 10 V
 S Setpoint
 R Pband
 I Actual value

Functional diagram for Mode **3.02** and **3.04** (Idealized principle diagram)

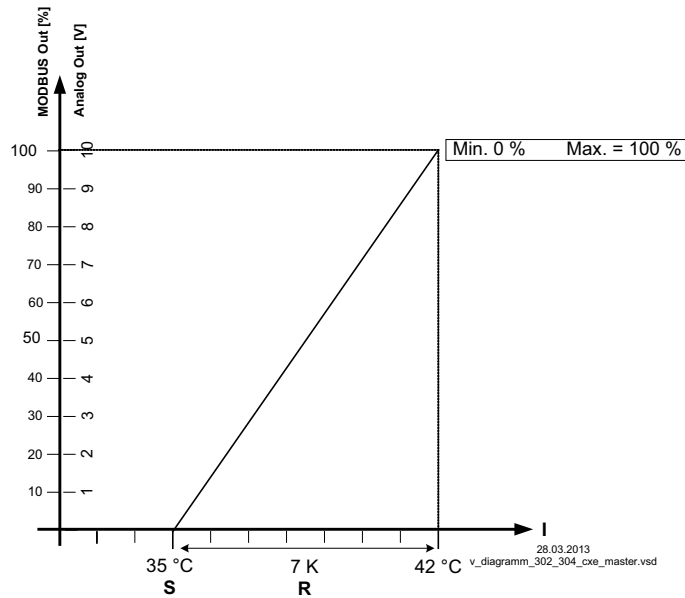

MODBUS Out: speed setting over MODBUS
 Analog Out: speed setting over analog output 0 - 10 V
 S Setpoint
 R Pband
 I Actual value



Information

The factory default presets must be adapted to match the system conditions by a competent person.

9.4 Pressure control airconditioning 4.01... 4.03

9.4.1 Base setup 4.01... 4.03

Main menu	Base setup
Start	
Setting	
Protocol	
Base setup	
Controller Setup	
Base setup	Mode
4.01	Mode selection e.g. 4.01
Mode	
Base setup	E1 Analog In
DSG200	The sensor input is factory set for modes of group 4 to sensor type "DSG200".
E1 Analog In	Measuring range: 0...200 Pa Output signal: 0 - 10 V Connection terminals: "E1", "GND", "24V"
	Other settable sensors / measuring ranges:
	<ul style="list-style-type: none"> "DSG 50", "DSG100", "DSG200", "DSG300", "DSG500", "DSG1000", "DSG2000", "DSG4000", "DSG6000", INT300, INT500 (numerical data $\hat{=}$ measuring range [Pa], output signal 0 - 10 V). Type designation DSG... $\hat{=}$ pressure sensor with new type designation MPG.. 0 - 10 V, 0 - 20 mA, 4 - 20 mA (for sensors with free measuring range and linear characteristic)
	The sensor measuring range must be entered for sensors with free measuring range in order to display the actual value correctly. Example with a 0 - 10 V sensor and 0 - 400 Pa measurement range: E1 Analog In = 0 - 10 V, E1 Unit = Pa, E1 Decimals = 1, E1 Min. = 0,0 Pa, E1 Max. = 400 Pa
Base setup	E1 Offset
0.0 Pa	Sensor calibration with calibrated comparison device.
E1 Offset	The current "E1 Actual" is displayed including the offset set here.

Base setup	E2 Function
OFF E2 Function	<p>The second signal input is not activated at the factory for modes with one sensor. The function is automatically jointly programmed in operating modes using two sensors. The second analog input is thus allocated and additional function allocations are not possible.</p> <p>Modes with two sensors</p> <ul style="list-style-type: none"> For 4.02 E2 Function at 6E preprogrammed = sensor for setpoint lowering. Preprogrammed sensor type "TF.." For 4.03 E2 Function at 6E preprogrammed = sensor for setpoint lowering. <ul style="list-style-type: none"> Preprogrammed sensor: type "0 - 10 V" (measuring range -35.0...+65.0 °C) <p>Pre-programmed in the IO setup:</p> <ul style="list-style-type: none"> To read out the sensor value via bus: E2 Busmode = "ON" For enabling via bus: D1 Function = 1D, D1 Busmode = "ON" For switch over setpoint 1 / 2 via Bus: D2 Function = 5D, D2 Busmode = "ON" <p>Adjustable "E2 function" for modes with one sensor</p> <ul style="list-style-type: none"> 1E = external setpoint e.g. by external signal (0 - 10 V) instead of setting "Setpoint 1". 0 - 10 V $\hat{=}$ 0 - 100 % sensor measuring range. 2E = External manual operation via external signal (0 - 10 V). Switch over between settings on the device and external manual operation via digital input (☞ IO Setup: function 7D). 3E = Sensor average to E1 4E = Sensor comparison to E1 5E = Sensor difference to E1 7E = Measurement value = Measurement value e.g. for limit indication, display in Info menu "E2 Actual". 8E ... 13E = sensor input for control circuit 2 ☞ base setup / operation with second control circuit.

9.4.2 Setting for operation modes 4.01... 4.03

- 4.01** Pressure control, Setting Setpoint in Pa
- 4.02** Pressure control setpoint depending on outdoor temperature
- 4.03** Pressure control with outdoor temperature-dependent setpoint adaptation and activation by MODBUS

Settings for controller output with function **2A** (by analogue signal ☞ IO Setup, by MODBUS ☞ members menu).

Main menu	Setting
Start	
Setting	
Protocol	
Base setup	
Controller Setup	
Setting	Setpoint1
100 Pa Setpoint1	Setting range: in measuring range of sensor Factory setting: 100 Pa
Setting	Setpoint2
..... Setpoint2	Setting "Setpoint 2" e.g. reduced value for night operation. Switch over Setpoint 1/2 by external contact (display as long as no allocation is carried out: ----- ☞ IO Setup).

Setting	Pband
100 Pa	Narrow control range = Short control times Wide control range = Longer control times and more stable control
Pband	Setting range: in measuring range of sensor Factory setting: 100 Pa
Setting	Min. Speed
0 %	Setting range: 0... "Max. Speed"
Min. Speed	Factory setting: 0 %
Setting	Max. Speed
100 %	Setting range: 100 %... "Min. Speed"
Max. Speed	Factory setting: 100 %
Setting	Manual mode
OFF	"OFF" = automatic control as function of the set parameters (Factory setting)
Manual mode	"ON" = automatic control without function, speed setting in menu "Speed manual"
Setting	Speed manual
100 %	Manual speed setting without influence by the external signal.
Speed manual	Activation by menu "Manual mode" or external contact at digital input (☞ IO Setup). Setting range: 0...100 % Δ "Min. Speed"... "Max. Speed" Factory setting: 100 %
	For information about deactivated regulation the adjusted value for manual speed is indicated alternating with the actual value.

Additional menu item for mode 4.02 and 4.03 with outside-temperature dependent target-setpoint.

Outside-temperature dependent target-setpoint

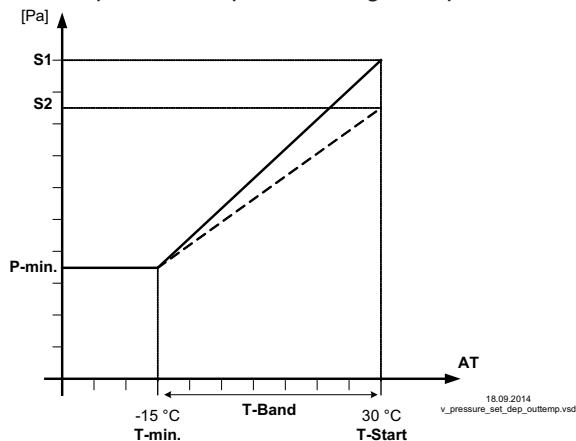

An outside temperature compensation can be activated (sensor connection "E2" = "Analog In 2") when being operated as a pressure regulation device.

An optimal building climate, e.g., can be achieved through this. Through this function, the set and active "Setpoint1" or "Setpoint2" is automatically changed proportional to the measured outside temperature (☞ Info: "Setpoint control").

- S1 Setpoint1
- S2 Setpoint2
- P-min. Min. Setpoint
- T-min Min. temperature
- T-Start Setpoint reducing will start below this outside temperature
- T-band Temperature range
- AT Outdoor temperature

Setting	T-Band SA
30 K	Temperature range in which the setpoint change continuously with outside temperature
T-Band SA	Setting range: 0.0..100.0 K Factory setting: 30.0 K

Setting	T-Start SA
15 °C T-Start SA	Setpoint reducing will start below this outside temperature Setting range: -10.0...40.0 °C Factory setting: 15.0 °C
Setting	Min. Setpoint
70.0 Pa Min. Setpoint	Minimum pressure for very low outside temperature Setting range: in measuring range of sensor Factory setting: 70 Pa

9.5 Volume control **5.01** and **5.02**

9.5.1 Basic setting **5.01** and **5.02**

Main menu	Base setup
Start	
Setting	
Protocol	
Base setup	
Controller Setup	
Base setup	Mode
5.01 Mode	Mode selection e.g. 5.01
Base setup	E1 Analog In
DSG200 E1 Analog In	The sensor input is factory set for modes of group 5 to sensor type "DSG200". Measuring range: 0...200 Pa Output signal: 0 - 10 V Connection terminals: "E1", "GND", "24V"
	Other settable sensors / measuring ranges:
	<ul style="list-style-type: none"> "DSG 50", "DSG100", "DSG200", "DSG300", "DSG500", "DSG1000", "DSG2000", "DSG4000", "DSG6000", INT300, INT500 (numerical data $\hat{=}$ measuring range [Pa], output signal 0 - 10 V). Type designation DSG... $\hat{=}$ pressure sensor with new type designation MPG.. 0 - 10 V, 0 - 20 mA, 4 - 20 mA (for sensors with free measuring range and linear characteristic)
	The sensor measuring range must be entered for sensors with free measuring range in order to display the actual value correctly. Example with a 0 - 10 V sensor and 0 - 400 Pa measurement range: E1 Analog In = 0 - 10 V, E1 Min. = 0,0 Pa, E1 Max. = 400 Pa
Base setup	K Factor
75 E1 K-Factor	Input of the "K factor" dependent on the fan (inlet duct). setting range: 0...5000 Factory setting: 75
Base setup	E1 Offset
0.0 Pa E1 Offset	Sensor calibration with calibrated comparison device.

Base setup	E2 Function
OFF E2 Function	The second signal input is not activated at the factory for modes with one sensor. The function is automatically jointly programmed in operating modes using two sensors. The second analog input is thus allocated and additional function allocations are not possible.
	<p>Modes with two sensors</p> <ul style="list-style-type: none"> For 4.02 E2 Function at 6E preprogrammed = sensor for setpoint lowering. Preprogrammed sensor type "TF.." <p>Adjustable "E2 function" for modes with one sensor</p> <ul style="list-style-type: none"> 1E = external setpoint e.g. by external signal (0 - 10 V) instead of setting "Setpoint 1". 0 - 10 V \triangleq 0 - 100 % setting range. 2E = External manual operation via external signal (0 - 10 V). Switch over between settings on the device and external manual operation via digital input (☞ IO Setup: function 7D). 3E = Sensor average to E1 4E = Sensor comparison to E1 5E = Sensor difference to E1 7E = Measurement value = Measurement value e.g. for limit indication, display in Info menu "E2 Actual". 8E... 13E = sensor input for control circuit 2 ☞ base setup / operation with second control circuit.

9.5.2 Setting for operation modes **5.01**...**5.02**

5.01 Volume control, Setpoint in m³/h

5.02 Volume control for ventilation systems setpoint depending on outdoor temperature

Settings for controller output with function **2A** (by analogue signal ☞ IO Setup, by MODBUS ☞ members menu).

Main menu	Setting
Start	
Setting	
Protocol	
Base setup	
Controller Setup	
Setting	Setpoint1
530 m³/h Setpoint1	Setting Setpoint in m ³ /h Setting range: depending on measuring range of sensor and "K factor" Factory setting: 530 m ³ /h
Setting	Setpoint2
----- Setpoint2	Setting "Setpoint 2" e.g. reduced value for night operation. Switch over Setpoint 1/2 by external contact (display as long as no allocation is carried out: ----- ☞ IO Setup).
Setting	Pband
530 m³/h Pband	Narrow control range = Short control times Wide control range = Longer control times and more stable control Setting range: depending on measuring range of sensor and "K factor" Factory setting: 530 m ³ /h
Setting	Min. Speed
0 % Min. Speed	Setting range: 0... "Max. Speed" Factory setting: 0 %

Setting	Maximal Speed
100 % Max. Speed	Setting range: 100 %... "Min. Speed" Factory setting: 100 %
Setting	Manual mode
OFF Manual mode	"OFF" = automatic control as function of the set parameters (Factory setting) "ON" = automatic control without function, speed setting in menu "Speed manual"
Setting	Speed manual
100 % Speed manual	Manual speed setting without influence by the external signal. Activation by menu "Manual mode" or external contact at digital input (☞ IO Setup). Setting range: 0...100 % \triangle "Min. Speed"... "Max. Speed" Factory setting: 100 %
	For information about deactivated regulation the adjusted value for manual speed is indicated alternating with the actual value.

Additional menu item for mode 5.02 with outside-temperature dependent target-setpoint

Outside-temperature dependent target-setpoint

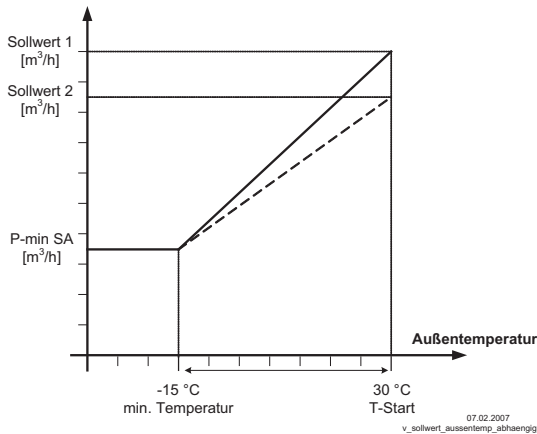

An outside temperature compensation can be activated (sensor connection "E2" to "Analog In 2") when being operated as a air volume regulation device.
An optimal building climate, e.g., can be achieved through this. Through this function, the set and active Setpoint 1/2 is automatically changed proportional to the measured outside temperature (☞ Info: "Setpoint control").

- S1 Setpoint1
- S2 Setpoint2
- P-Min SA Minimum air volume
- T-min Minimum temperature
- T-Start Setpoint reducing will start below this outside temperature
- AT Outdoor temperature

Setting	T-Band SA
30.0 K T-Band SA	Temperature range in which the setpoint change continuously with outside temperature Setting range: 0.0..100.0 K Factory setting: 30.0 K
Setting	T-Start SA
15.0 °C T-Start SA	Setpoint reducing will start below this outside temperature Setting range: -10.0...40.0 °C Factory setting: 15.0 °C
Setting	Min. Setpoint
700 m³h Min. Setpoint	Minimum pressure for very low outside temperature Setting range: depending on measuring range of sensor and "K factor" Factory setting: 700 m³/h



9.6 Air velocity control **6.01**



9.6.1 Base setup **6.01**

Main menu	Base setup
Start	
Setting	
Protocol	
Base setup	
Controller Setup	
Base setup	Mode
6.01	Mode selection 6.01
Mode	
Base setup	E1 Analog In
MAL1	The sensor input is factory set for mode 6.01 to sensor type "MAL1".
E1 Analog In	Measuring range: 0...1 m/s Output signal: 0 - 10 V Connection terminals: "E1", "GND", "24V"
	Other settable sensors / measuring ranges:
	<ul style="list-style-type: none"> • MAL10 (0...10 m/s, output signal 0 - 10 V) • MAL15 * (0...15 m/s, output signal 0 - 10 V) • MAL20 * (0...20 m/s, output signal 0 - 10 V) • 0 - 10 V, 0 - 20 mA, 4 - 20 mA (for sensors with free measuring range and linear characteristic)
	The sensor measuring range must be entered for sensors with free measuring range in order to display the actual value correctly. Example 0 - 10 V sensor and measuring range 0 - 5 M/s: E1 Analog In = 0 - 10 V, E1 Unit = m/s, E1 Decimals = 1, E1 Min. = 0,0 m/s, E1 Max. = 5 m/s
	* Alternative measuring ranges which can be selected by jumpers for sensor type MAL10.
Base setup	E1 Offset
0.00 m/s	Sensor calibration with calibrated comparison device.
E1 Offset	The current "E1 Actual" is displayed including the offset set here.
Base setup	Adjustable "E2 Function"
OFF	<ul style="list-style-type: none"> • 1E = external setpoint e.g. by external signal (0 - 10 V) instead of setting "Setpoint 1". 0 - 10 V $\hat{=}$ 0 - 100 % sensor measuring range. • 2E = External manual operation via external signal (0 - 10 V). Switch over between settings on the device and external manual operation via digital input (☞ IO Setup: function 7D). • 3E = Sensor average to E1 • 4E = Sensor comparison to E1 • 5E = Sensor difference to E1 • 6E = sensor for outdoor temperature-dependent setpoint adaptation, pre-programmed sensor type "TF..". <ul style="list-style-type: none"> – Menu group "Setting" additional parameter: T-Band, T-Start SA, Min. Setpoint. – Menu group "Info" additional parameter: Setpoint control – Example ☞ Setting for operation 4.01... 4.03 / additional menu items. • 7E = Measurement value = Measurement value e.g. for limit indication, display in Info menu "E2 Actual". • 8E... 13E = sensor input for control circuit 2 ☞ base setup / operation with second control circuit.

9.6.2 Settings for operation modes **6.01**

6.01 Air velocity control, Setpoint in m/s

Settings for controller output with function **2A** (by analogue signal  IO Setup, by MODBUS  members menu).

Main menu	Setting
Start	
Setting	
Protocol	
Base setup	
Controller Setup	
Base setup	Setpoint1
0.50 m/s Setpoint1	Setting range: in measuring range of sensor Factory setting: 0.50 m/s
Base setup	Setpoint2
----- Setpoint2	Setting "Setpoint 2" e.g. reduced value for night operation. Switch over Setpoint 1/2 by external contact (display as long as no allocation is carried out:  IO Setup).
Base setup	Pband
0.50 m/s Pband	Narrow control range = Short control times Wide control range = Longer control times and more stable control Setting range: in measuring range of sensor Factory setting: 0.50 m/s
Base setup	Min. Speed
0 % Min. Speed	Setting range: 0... "Max. Speed" Factory setting: 0 %
Base setup	Max. Speed
100 % Max. Speed	Setting range: 100 %... "Min. Speed" Factory setting: 100 %
Base setup	Manual mode
OFF Manual mode	"OFF" = automatic control as function of the set parameters (Factory setting) "ON" = automatic control without function, speed setting in menu "Speed manual"
Base setup	Speed manual
100 % Speed manual	Manual speed setting without influence by the external signal. Activation by menu "Manual mode" or external contact at digital input ( IO Setup). Setting range: 0...100 % Δ "Min. Speed"... "Max. Speed" Factory setting: 100 %
	For information about deactivated regulation the adjusted value for manual speed is indicated alternating with the actual value.

9.7 Menu group Start

Main menu	Start
Start	
Settings	
Protocol	
Base setup	
Controller Setup	
Start	PIN input
-----	The service menu for the installation can be protected against unintentional changes by a pin code. With further pin codes putting back to pre-setting is possible.
PIN input	
	PIN 0010 Opening service menu, if PIN-protection activated.
	PIN 1234 Opening "setting". if "set protection" = "ON" (☞ Controller Setup)
	PIN 9090 Restore user setting.
	PIN 9091 Save user setting (corresponds function "Save user setup" = "ON"☞ Controller Setup)
	PIN 9095 Restore factory setting = delivery status Exception: The stored events in the "Protocol" menu are retained after resetting to factory setting!
Start	Language
GB	Menu language by the factory set to English.
Language	In this menu different national languages can be selected (GB = English, D = German ...).
	US Einheiten
OFF	The display can be switched between SI units and imperial (US) units =>US units ON.
US Einheiten	SI units (factory setting): °C, bar, Pa, m ³ /h, K-Faktor, m/s Imperial (US) units: °F, psi, in.wg, cfm, K-Faktor US, ft/s Settings for temperature differences (with SI units in K) are also made for Imperial units (US) in °F ($\Delta 1.8 \text{ }^\circ\text{F} \hat{=} \Delta 1 \text{ K}$). Conversion factors: <ul style="list-style-type: none"> • Temperature: $t / \text{ }^\circ\text{F} = 1,8 \times t \text{ }^\circ\text{C} + 32$. • Pressure: 1,0 psi = 0,069 bar, 1,0 in.wg = 254 Pa • Air flow: 1,0 cfm = 0.5885 m³/h, inlet ring: K-Faktor US = 9,3 x K-Faktor SI • Speed: 1.0 ft/s = 0.3048 m/s In order to refresh the display, the desired mode must be confirmed again after switching over the units (☞ Base setup)!
Start	Reset
OFF	Complete re-start of the device
Reset	
Start	Mode
1.01	Query of the operating mode (e.g. 1.01 for speed controller)
Mode	

Start	Device name
9.15 xxx	Display of device name and software version
Start	Individual unit number
SN: 154036311039	

9.8 Menu group Info

The first menu item in the Info menu group is displayed (display dependent on selected mode) after switching on the line voltage or after exiting the setting menu with the Esc key combination.
Settings cannot be made in this menu group!

Info for mode speed controller 1.01											
Info	Level modulation control output.										
0 % Control	The percentage modulation factor is displayed in addition to the bar chart.										
Info	Display of the currently active default signal.										
0 % Set external1	The percentage corresponds to the internal actuation of the device under consideration of the settings "Min. speed" and "Max. speed". 0 - 100 % $\hat{=}$ 0 - 10 V, 10 - 0 V, 0 - 20 mA, 20 - 0 mA, 4 - 20 mA, 20 - 4 mA										
	<table border="1" style="width: 100%;"> <tr> <td>Display:</td> <td>The device operates at:</td> </tr> <tr> <td>"Set external1"</td> <td>Signal to "E1" / "GND"</td> </tr> <tr> <td>"Set external2"</td> <td>Signal to "E2" / "GND"</td> </tr> <tr> <td>"Set Intern1"</td> <td>Menu "Set Intern1"</td> </tr> <tr> <td>"Set Intern2"</td> <td>Menu "Set Intern2"</td> </tr> </table>	Display:	The device operates at:	"Set external1"	Signal to "E1" / "GND"	"Set external2"	Signal to "E2" / "GND"	"Set Intern1"	Menu "Set Intern1"	"Set Intern2"	Menu "Set Intern2"
Display:	The device operates at:										
"Set external1"	Signal to "E1" / "GND"										
"Set external2"	Signal to "E2" / "GND"										
"Set Intern1"	Menu "Set Intern1"										
"Set Intern2"	Menu "Set Intern2"										
Info for mode controller 2.01... 6.01											
Info	Only for mode 2.05										
0 °C E1-E2 actual	Current actual value difference sensor 1 - sensor 2 (unit depending on the programming).										
Info	Only for mode 2.04, 3.03, 3.04 (E2 function = 4E)										
0 °C Control value	The highest value determined automatically from two sensor measuring values which is used as the actual value for the control (unit depending on programming).										
Info	Only for mode 2.04 programmed for averaging (E2 function = 3E).										
49.9 °C Average E1/E2											
Info	Current actual value measured at sensor 1 (unit depending on programming).										
0 °C E1 Actual											
Info	Display for "actual value 2" for operation with two sensors.										
0 °C E2 Actual	Display if function not active: -----										

Info	Display of the active target value at which the device operates.
0 °C Setpoint1	"Setpoint1" Menu "Setting" "Setpoint2" Menu "Setting" "Ext. Setpoint" = setting by external signal 0-10 V. With activated manual mode the display constantly changes between actual value and value for manual mode. Display for operation with two control circuits: "1.Setpoint 1" or "1.Setpoint 2" for control circuit 1 "2.Setpoint 1" or "2.Setpoint 2" for control circuit 2
Info	Only for mode 4.02 , 4.03 , 5.02 with setpoint depending on outdoor temperature (E2 function = 6E).
100.0 Pa Setpoint control	
Info	Level modulation control output.
0 % Modulation	In addition to the bar chart, the level of the output voltage is indicated. The modulation for each control circuit is displayed in operation with two control circuits: "1. Modulation" for control circuit 1 "2. Modulation" for control circuit 2
Info	Momentarily status for minimum speed cut off
OFF Min. speed cut off	"ON" = switch off, if Setpoint (+/- "Min. speed cut off") is reached. "OFF" = no switch off that means operation with minimum rate of air. Display for operation with two control circuits: "1. Min. speed cut off" for control circuit 1 "2. Min. speed cut off" for control circuit 2

9.9 Controller Setup

9.9.1 PIN protection activate, PIN 0010

Controller Setup	The adjustments for the installation in the service level can be protected against unintentional modifications. To do this, activate the "PIN protection" = "ON".
OFF PIN Protection	In order to simplify the initial start-up operation, the service level in the factory setting is free = "OFF" i.e. accessible without PIN 0010 .

Available menu groups with activated PIN-protection

Main menu	
Start	
Setting	
Protocol	

If PIN-protection is switched on, it automatically becomes active after about 15 minutes without keys being pressed.

Possibilities for early activation of PIN protection:

- Execute the "Reset" function in the "Start" menu group.
- By switching the mains voltage off and then on again.



Information

After installation of the device has been carried out, "PIN-Protection" should be activated = "ON"

9.9.2 PIN protection activate, PIN 1234

Controller Setup	The "Settings" menu for the user's basic settings (Setpoint, default value, min, max ..) are freely accessible when using the factory settings (i.e. without "PIN").
OFF Set protection	If necessary, these can also be protected against unauthorized modifications by using a "PIN 1234". For this, the settings protection must be programmed to "ON". The settings menu is then no longer visible without inputting a PIN!
	Function only in combination with activated PIN-Protection!

Available menu groups with activated PIN-protection + setting protection

Menu	
Start	
Protocol	

9.9.3 Save user settings restore with PIN 9090

Controller Setup	The individually made device configurations (User Setting) can be saved here (corresponds to PIN 9091).
OFF Save User Setup	By entering PIN 9090 the individually made device configurations can be reestablished (☞ Start - PIN Input).
	A file (userconf.csv) is generated and saved on the main drive (root directory) when saving the user setting. The data can be accessed via the ZAsset program.





Information

By entering the "PIN 9095" in the "PIN" menu of the "Start" menu group the device is reset to the as-delivered state (except for the saved events in the "Protocol" menu). Any changes that have been made to the settings are thus lost.

9.9.4 Sensor Alarm ON / OFF

The inputs "E1 Analogue In" and if Sensor 2 is activated "E2 Analogue In" are monitored. In case of an interruption or short-circuit in the sensor conductor, or in case of measured values that lie outside of the device's measurement range, a time-delayed fault indication takes place. Function only in controller mode (from **2.01**)!

Controller Setup	With "Alarm Sensors" = "ON" (factory setting). Indicated sensor disturbances are displayed as "Alarm" alternating to the actual value and stored in the menu of "Protocol".	 Sensor 1
ON Alarm sensors	A programmed alarm relay (factory setting relay K2) indicates the sensor failure.	
Controller Setup	With "AlarmSensors" = "OFF" are indicated sensor disturbances as "Message" alternating to the actual value and stored in the menu of "Protocol".	 Sensor 1
OFF Alarm sensors		

9.9.5 Limit

Controller Setup	After allocation of a digital input (☞ IO Setup) an adjustable limitation of the modulation can be activated via a digital input (“D1”, “D2”, ..).
----- Limit	Display as long as no allocation has been carried out in “IO Setup”: <input type="checkbox"/> --- The limitation influences both outputs in operation with two control circuits.

“Limit value” = max. possible modulation (e.g. speed reduction during night operation by time switch).
 Setting range: “Limit” = “Min. Speed” to “Max. Speed”.
 Factory setting: 100 % $\hat{=}$ max. modulation, i. e. no limit.
 Setting depending on device tye in: % or rpm.

Limit (idealized principle diagram)
 MODBUS Out: speed setting over MODBUS
 Analog Out: speed setting over analog output 0 - 10 V
 L Limit
 S Setpoint
 R Pband
 D Speed controller: setting signal
 P P-controller: control deviation

9.9.6 Minimum speed cut off

Controller Setup	This function is primarily significant for installation of the device as a pure P Controller in refrigeration and air-conditioning technology.
OFF Min. speed cut off	For operation mode speed controller 1.01 without function!
	Display for operation with two control circuits: “1. Min. speed cut off” for control circuit 1 “2. Min. speed cut off” for control circuit 2

Msc0 = OFF (factory setting)
 If no “Min. speed” is adjusted, the fan stops with reaching the desired value.
 If “Min. speed” is adjusted (e.g. 20%), then no disconnection of the fan takes place. I.e., always a minimum ventilation is ensured (fan does not go under setting “Min. speed”).

Msc0. e.g. -2.0 K
 It takes place a disconnection from setting “Min. speed” to “0”, if the given difference is reached related to the desired value.
 At a plus value (+) before reaching the desired value
 At a minus value (-) after falling below the desired value.

Minimum speed cut off (idealized principle diagram)
 MODBUS Out: speed setting over MODBUS
 Analog Out: speed setting over analog output 0 - 10 V
 S Setpoint
 R Pband
 I Actual value

9.9.7 Reverse action of the control function

Controller Setup	<p>For the effect of the regulation there are two functions:</p> <ul style="list-style-type: none"> • ON for “Val>Set=n+” $\hat{=}$ increasing Fanlevel for increasing actual value over Setpoint. • OFF for “Val>Set=n+” $\hat{=}$ increasing Fanlevel for decreasing actual value below Setpoint. <p>Display for operation with two control circuits: “1. Actual>Set=n” for control circuit 1 “2. Actual>Set=n” for control circuit 2</p> <p>For special applications an external switch over of the control function is possible (☞ IO Setup).</p>
<p>ON Val>Set=n+</p>	

Factory setting depending on selected mode	Example for temperature control (Idealized principle diagram)														
<table border="1"> <thead> <tr> <th>Mode</th> <th>Controller function</th> </tr> </thead> <tbody> <tr> <td>1.01</td> <td>non</td> </tr> <tr> <td>2.01...</td> <td>ON</td> </tr> <tr> <td>3.01...</td> <td>ON</td> </tr> <tr> <td>4.01...</td> <td>OFF</td> </tr> <tr> <td>5.01...</td> <td>OFF</td> </tr> <tr> <td>6.01...</td> <td>OFF</td> </tr> </tbody> </table>	Mode	Controller function	1.01	non	2.01...	ON	3.01...	ON	4.01...	OFF	5.01...	OFF	6.01...	OFF	<p>MODBUS Out: speed setting over MODBUS Analog Out: speed setting over analog output 0 - 10 V R Pband S Setpoint I Actual value OFF for Val>Set=n+ = heating function ON for Val>Set=n+ = cooling function</p>
Mode	Controller function														
1.01	non														
2.01...	ON														
3.01...	ON														
4.01...	OFF														
5.01...	OFF														
6.01...	OFF														

9.9.8 Controller configuration

The “controller configuration” is automatically carried out during selection of the application related mode of operation (Base setup). The factory presets in accordance with the mode of operation are based on many years of experience, which is suitable for many applications. Under special circumstances, these can be individually adapted (☞ Menu group “setting”).

Controller Setup	<p>The type of control determines the method with which the controlled value behaves in case of a difference between the target and current values. For this, the control technology has standard algorithms, which consist of a combination of three methods:</p> <p>Selection P, PID:</p> <ul style="list-style-type: none"> • P control (Proportional component, proportion of the absolute deviation) • I control (Integral component, proportion of the sum of all deviations) • D control (Differential component, proportion of the last difference) <p>Display for operation with two control circuits: “1.Controller type” for control circuit 1 “2.Controller type” for control circuit 2</p>
<p>P Type of control</p>	
<p>With pure P controllers (controller type P), the following described settings do not have any function. If needed, the most suitable combination for the respective control system can be determined from these proportions.</p>	
<p>The control configuration (KP, KI, KD, TI) is identical for both control circuits in operation with two control circuits. Fine adjustment is possible for each control circuit by the separate “Pband” setting.</p>	

Controller Setup	P-component = reaction time
50 % KP	Setting range: 0 - 200 % smaller = more slowly bigger = faster
Controller Setup	I-component = accuracy, correction time
50 % KI	Setting range: 0 - 200 % bigger = faster smaller = more slowly
Controller Setup	D-component
50 % KD	More "D-component" causes more stability by a clean actual value signal with shorter correction times By a actual value signal with a superposition should be done to attitude without "D-component" → 0 % Setting range: 0 - 200 % value smaller = less "D-component" value higher = more "D-component"
Controller Setup	Integration time = correction time
0 % TI	Setting range: 0 - 200 % smaller = faster bigger = more slowly

9.9.9 Group control

Fan groups can be activated by the analogue outputs “A1” and “A2”, the relay outputs “K1” and “K2” or by the RS-485 interface for MODBUS RTU.

Controller Setup	Setting range 0 / 1
0 Group version	Following group versions are available: <ul style="list-style-type: none"> • 0: One controlled group and up to three switched groups (factory setting) • 1: Two controlled groups

Group control via analogue outputs and relays

- The groups must be connected at the appropriate programmed output when activating by the analogue outputs and relays.
- The assignment of the analogue outputs and the relays for the group control takes place in the IO Setup.
- The number of possible groups depends on the available hardware outputs in the MODBUS Master (maximum of 4 groups possible).

Group control im MODBUS Master Operation

- If controlling via MODBUS, an individual function can be programmed for each group device.
- The virtual outputs are assigned after the menu group “MODBUS Master” for the respective component “fan 1” ..“fan xx”.
- The number of possible groups does **not depend** on the available hardware outputs in the MODBUS Master (maximum of 4 groups possible).

Group functions (☞ IO Setup)

Analog output A1, A2
MODBUS A1, A2

2A = Group 1
5A = Group 2
11A = Group 3
12A = Group 4

Relay output K1, K2

8K = Group 2
12K = Group 3
13K = Group 4



Information

- Group activation by analogue output, relay and MODBUS can also be combined.
- Ensure an ascending and complete sequence when assigning the groups. This means that if, for example, the function for a fourth group was assigned for an output, there must already be an assignment for groups 2 and 3 (☞ IO Setup).
- The group control only becomes active once a group function is allocated to an output (analogue, relay, MODBUS).

9.9.9.1 Variant “0”: One controlled group and up to three switched groups

The programming described below applies equally for group control by analogue outputs, relay outputs and MODBUS.

For group control by the analogue outputs “A1” / “A2” and the relay outputs “K1” and “K2”, the available outputs must be observed in the selection of the version (combinations are possible).

Example: Required assignment for a controlled and a switched group

- For activation by analogue output (☞ IO Setup) or MODBUS (☞ MODBUS Master)
 - Function [A] for group 1 (0 - 100 % controlled)
 - Function [5A] for group 2 (0 / 100 % switched)
- For activation of Group 2 by relay (☞ IO Setup)
 - Function [A] for group 1 (0 - 100 % controlled)
 - Function [8K] for group 2 (ON / OFF switched)

The function [11A] must be allocated additionally to Group 3 for one controlled and two switched groups.

The function [12A] must be allocated additionally to Group 4 for one controlled and three switched groups.

Controller Setup	Group 2 ON value
50 % Group 2 ON value	Switch-on value for Group2 Setting range: 0 - 100 % Factory setting: 50 % *
Controller Setup	OFF Value Group2
45 % OFF Value Group2	Switch-off value for group2 Setting range: 0 - 100 % Factory setting: 45 % *
Controller Setup	nmin at Group2
20 % nmin at Group2	Minimum Value for Group2 Setting range: 0 - 100 % Factory setting: 20 % *
Controller Setup	Group 3 ON value
70 % Group 3 ON value	Switch-on value for Group3 Setting range: 0 - 100 % Factory setting: 70 % *
Controller Setup	OFF Value Group3
65 % OFF Value Group3	Switch-off value for group3 Setting range: 0 - 100 % Factory setting: 65 % *
Controller Setup	nmin at Group3
30 % nmin at Group3	Minimum Value for Group3 Setting range: 0 - 100 % Factory setting: 30 % *
Controller Setup	Group 4 ON value
85 % Group 4 ON value	Switch-on value for Group4 Setting range: 0 - 100 % Factory setting: 85 % *

Controller Setup	OFF Value Group4
80 % OFF Value Group4	Switch-off value for group4 Setting range: 0 - 100 % Factory setting: 80 % *
Controller Setup	nmin at Group4
40 % nmin at Group4	Minimum Value for Group4 Setting range: 0 - 100 % Factory setting: 40 % *

* Display as long as no group assignment via analogue output, relay, MODBUS: ---

Higher settings must be selected for following groups and the switch-off value of the group must be below the switch-on value.

Example version “0” via MODBUS

On controlled group and three switched groups

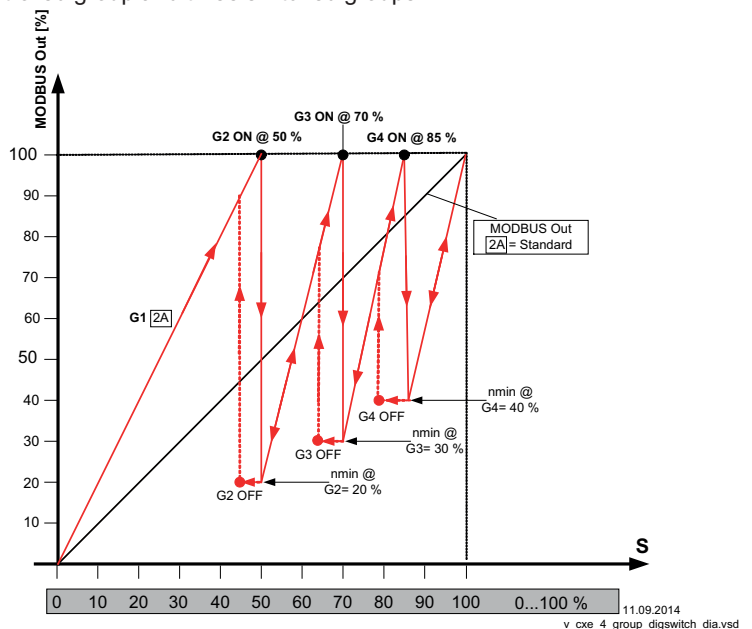
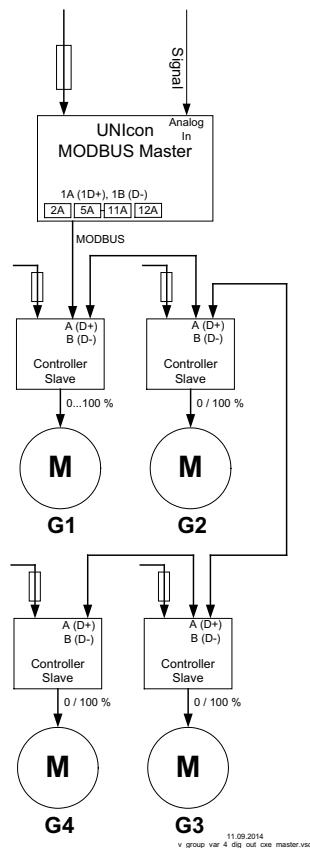

MODBUS Out: speed setting over MODBUS
 S: Modulation level of the controller in %
 G1: Group 1
 G2: Group 2
 G3: Group 3
 G4: Group 4
 G2, G3, G4 ON: ON Value Group2, 3, 4
 G2, G3, G4, OFF: OFF Value Group2, 3, 4
 nmin@G 2, 3, 4: nmin at Group2, 3, 4
 MODBUS Out Standard: Diagram without group control

Function

Group 1 is continuously controlled (0 - 100 %), the other groups are switched on and off depending on the degree of modulation (0 / 100%).
 If the modulation level exceeds the switch-on point “ON Value Group2”, the MODBUS Master switches on the second group and the speed of the first group is reduced to an adjustable minimal value “nmin at Group2”.
 Then the speed of the first group increases to maximum within the remaining range.
 If a third group is programmed up to switch-on point “ON Value Group3” etc.
 Switch-off point “OFF Value Group2” at diminishing speed requirement.

Controller Setup	Group 2 ON value Switch-on value for Group2 Setting range: 0 - 100 % Factory setting: 50 % *
50 % Group 2 ON value	
Controller Setup	OFF Value Group2 Switch-off value for group2 Setting range: 0 - 100 % Factory setting: 45 % *
45 % OFF Value Group2	
Controller Setup	nmin at Group2 Minimum Value for Group2 Setting range: 0 - 100 % Factory setting: 20 % *
20 % nmin at Group2	

* Display as long as no group assignment via analogue output, relay, MODBUS:

Example version “1”: Two controlled groups

Second Group over analog output

Second Group over MODBUS output

Function

If the modulation level of the controller exceeds the switch-on point of group 2 (On Value Group2), group 1 is reduced to “n-min at Group2”. From here on both groups run parallel at maximum power.

If group control is activated (Function = 5A) the gradient of the output curve of group 1 is automatically increased by factor 1.4 (gradient without group control = 1).

MODBUS Out: speed setting over MODBUS
Analog Out: speed setting over analog output 0 - 10 V
G1: Group 1
G2: Group 2
S: Modulation level of the controller in %
G 2 ON: Group 2 ON value
G2 OFF: OFF Value Group2
nmin @ G2: nmin at Group2
Analog / MODBUS Out Standard: Diagram without group control

9.9.10 Display text for external message

Controller Setup	Alternatively to the “External Error” display when an external message occurs (🔊 IO Setup / Digital Inputs “D1” / “D2” the following error texts can be programmed:
External error External message	<ul style="list-style-type: none"> • EC Motors • Filter • Frost protection • Adiabatic • Firealarm • Pressure switch • Gas alarm • Water alarm • RCD

RCD Residual-current-operated protective device

9.9.11 Offset control signal

Controller Setup	Offset control sig. 1
0 % Offset control sig. 1	<p>If required, the characteristic of the control signal for control circuit 1 can be adjusted. To activate this function, re-program the output with function 2A to function 14A.</p> <p>IO Setup.</p> <p>Setting range: 0 - 50 %</p> <p>Factory setting: 0 % (characteristic curve unchanged)</p>

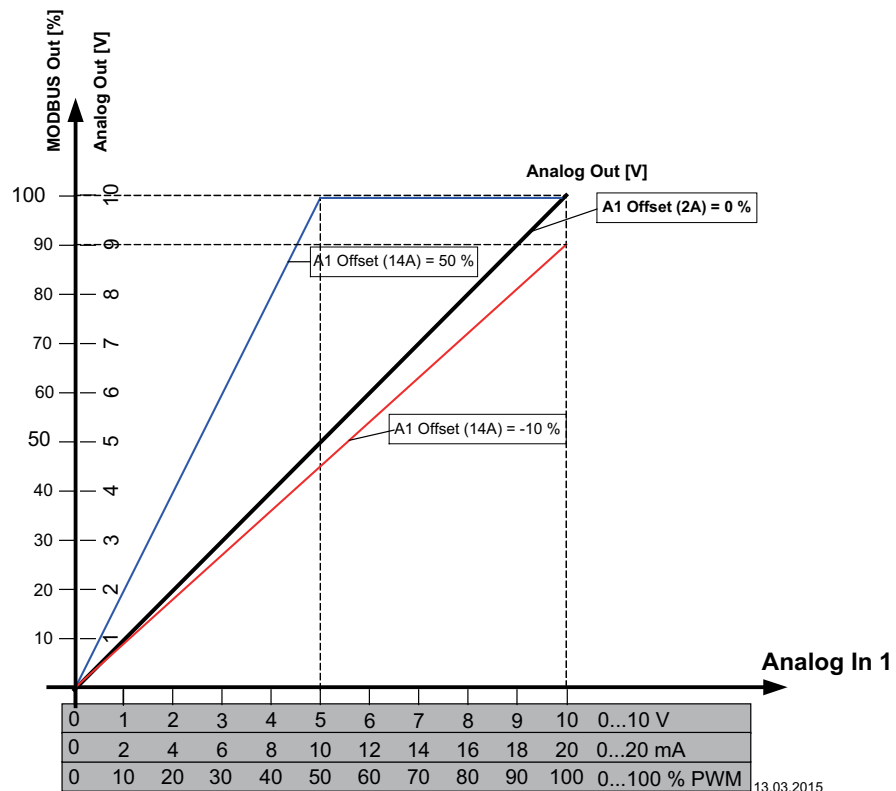

9.9.12 Selection amplifier (comparator) control circuit 1 or 2 at output A1

Controller Setup	<p>If using two control circuits, the control circuit with the higher modulation can be selected to affect the power component of the device.</p> <p>This function can be used for refrigeration systems with combined refrigerant circuit and floating brine pressure control circuits, for example.</p> <p>Example:</p> <ul style="list-style-type: none"> Control circuit 1 is used for the refrigerant circuit. A pressure sensor is connected to determine the actual value. The setpoint and control range are set in bar. Control circuit 2 is used for the brine pressurised circuit. A temperature sensor is connected to determine the actual value. The setpoint and control range are set in C° / K. Depending on which control circuit produces the higher modulation (depending on the measured and set values), the pressure control or temperature control is used as a specification for the power component. <p>Selection amplifier = OFF (factory setting) No comparison of the two control circuits.</p> <p>Selection amplifier = ON Comparison of the modulation of control circuit 1 and control circuit 2 with automatic control active at the highest value.</p>
OFF Selection amplifier	

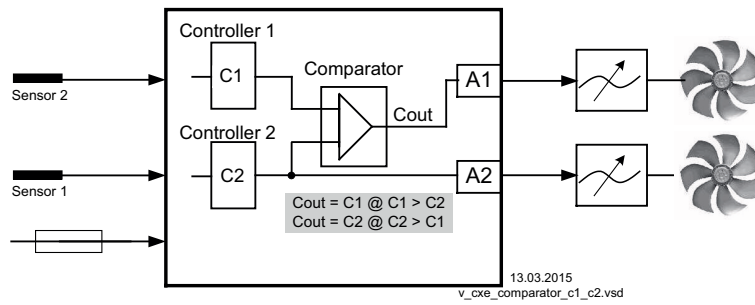

9.9.13 Data on the total control deviation

The total control deviation is comprised of the sum of the control deviations for performance quantities and work quantities combined and refers to the specified areas.

In direct reference to the acquired input and controlled variables, the maximum deviation to the target value is $< \pm 5\%$. By activating the menu-assisted adjustment, the total control deviation can be reduced to a value of $< \pm 1\%$.

For indirect reference of the acquired input value to the controlled variable, i.e., two physical variables still need to be converted, the deviation can be reduced to $< \pm 5\%$ through adjustment.

In the case of an internal default value through the integrated or external terminal, the control deviation remains at $< \pm 0.5\%$.

9.10 IO Setup

9.10.1 Analog outputs “A1”/ “A2”

IO Setup	The analog outputs 0 - 10 V (A1 and A2) can be allocated with various functions.
1. Control signal (2A) A1 Function	
IO Setup	With the settings “A1 min.” / “A2 min.” and “A1 max.” / “A2 max.” the characteristic of the output voltage can be adapted.
0.0 V A1 min.	Setting range: “A1 min.” / “A2 min.” = 0 - 10 V “A1 max.” / “A2 max.” = 0 - 10 V
IO Setup	Factory setting: “A1 min.” / “A2 min.” = 0 V “A1 max.” / “A2 max.” = 10 V
10.0 V A1 max.	
	The setting for “A1 min.” / “A2 min.” must be below “A1 max.” / “A2 max.”.

IO Setup	Inverting of the output voltage is possible with the settings "A1 Inverting" / "A2 Inverting".
OFF A1 Inverting	Factory setting: Inverting = "OFF"

Function	Description
OFF	no function
Constant voltage 10 V (1A)	Constant voltage +10 V Factory setting for "A2" at operation with one control circuit.
1st control signal (2A)	Controlled 0 - 10 V output for control circuit 1 (factory setting for "A1")
E1 (3A)	proportional input "E1"
E2 (4A)	proportional input "E2"
Group2 (5A)	Group control (☞ Controller Setup - group 2)
2.Cooling (6A)	Only for mode 2.03 temperature controller with additional functions. Controller output 2 with rising activation at Actual>Nominal = Cool .
2.Heating (7A)	Only for mode 2.03 temperature controller with additional functions. Controller output 2 with rising activation at Actual<Nominal = Heat .
2. control signal (8A)	Controlled 0 - 10 V output for control circuit 2 (factory setting for "A2" at operation with second control circuit). Control circuit 2 can be activated by programming the E2 function if required (☞ Base setup / operation with second control circuit).
Speed (9A)	proportionally 1.Control signal
Group3 (11A)	Group control (☞ Controller Setup - group 3)
Group4 (12A)	Group control (☞ Controller Setup - group 4)
Offset control sig. 1 (14A)	Offset control signal 1 Setting offset ☞ Controller Setup

"A1 min." / "A2 min." and "A1 max." / "A2 max."

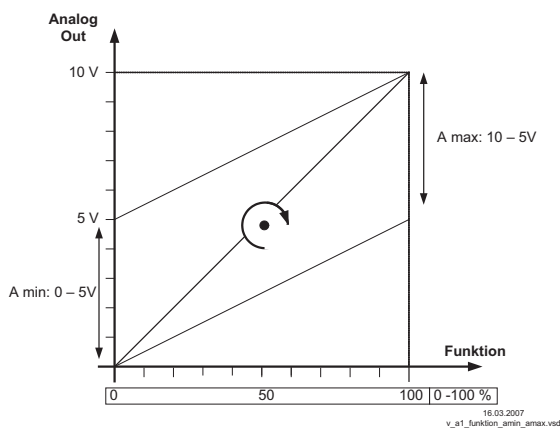

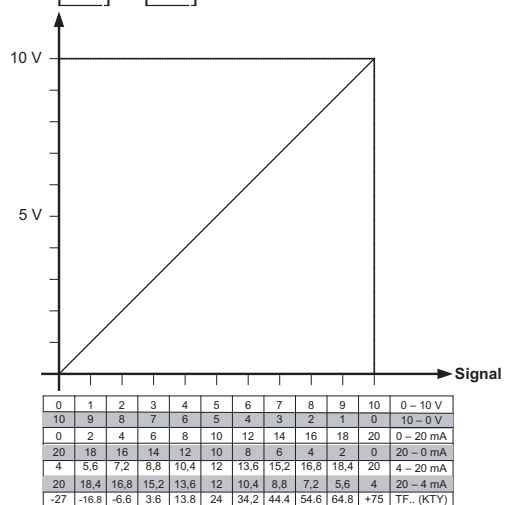

Function **3A** / **4A**



9.10.2 Digital inputs “D1” / “D2”

9.10.2.1 Menu overview

IO Setup	
OFF D1 Function	Possible functions for D1  following table.
IO Setup	
OFF D1 Inverting	To invert the function, switch to “ON” (display <input type="text" value="-- --"/> as long as no function is allocated for D1).
IO Setup	
ON D1 Busmode	With networking the digital inputs can be replaced by control over bus (Slave interface 2A/2B). With mode of operation 4.03 pre-setting of “D1” is <input type="text" value="ON"/> . If bus mode is at <input type="text" value="ON"/> , the digital input can be set by coil register c0 for D1.
IO Setup	
OFF D2 Function	Possible functions for D2  following table.
IO Setup	
OFF D2 Inverting	To invert the function, switch to “ON” (display <input type="text" value="-- --"/> as long as no function is allocated for D2).
IO Setup	
ON D2 Busmode	With networking the digital inputs can be replaced by control over bus (Slave interface 2A/2B). With mode of operation 4.03 pre-setting of “D2” is <input type="text" value="ON"/> . If bus mode is at <input type="text" value="ON"/> , the digital input can be set by coil register c1 for D2.
IO Setup	
OG D - D Relation	If the digital inputs have the same function allocation (also applies for timer function) you can choose between an AND and OR operation. OR operation (factory setting). The function becomes active when one of the digital inputs or the timer is activated. AND operation. The function becomes active when all digital inputs or also the timer are activated.

Function	Description
OFF	No function (factory setting)
Enable (1D)	Enable (remote control) “ON” / “OFF”
External error (2D)	External fault alarm
Limit (3D)	“Limit” ON / OFF Influences control circuit 1 and control circuit 2 in operation with two control circuits
E1 / E2 (4D)	Switch over input “E1” / “E2” (for operation with one control circuit)
Reset (10D)	Complete re-start of the device

Max. Speed (11D)	Setting Max. Speed "ON" / "OFF" Influences the respectively set value "1. Max. Speed" and "2. Max. Speed" in operation with two control circuits.
Override Time (21D)	Override timer function (in operation with timer) The timer output is overwritten for a settable time with a selectable status (ON / OFF).
For Mode Speed controller 1.01	
Setpoint1/2 (5D)	Switch over "Set Intern1" / "Set Intern2" "Setting External 1" must be at "OFF".
Setpoint int./ext. (6D)	Switch over "Intern" / "Extern"
For modes as controller (from 2.01)	
Setpoint1/2 (5D)	Switch over "Setpoint 1" / "Setpoint 2" for control circuit1
Setpoint int./ext. (6D)	Switch over "Intern" / "Extern" Possible only for operation with one control circuit!
Control/Manual (7D)	Switch over "automatic control" / "Speed manual" Possible only for operation with one control circuit!
Heating/Cooling (8D)	Switch over control function (e.g. "heating" / "cooling")
1.Setp+Pband1/2 (15D)	for control circuit 1: Switch over Setpoint 1/2 and Pband 1/1 When programming this function, "Setting" additionally lists the parameter: "1.Pband2 for control circuit 1."
Only active in operation with a second control circuit!	
E1 / E2 (4D)	The output for control circuit 2 is set additionally to "A2" to "A1" (regardless of the programmed function for "A1"). Control circuit 1 has no output for the duration of the switching. The switch over input "E1" / "E2" as in operation with one control circuit is no longer possible.
2. Setpoint 1/2 (9D)	for control circuit 2: Switch over "2. Setpoint 1" / "2. Setpoint 2"
2.Setp+Pband1/2 (16D)	for control circuit 2: Switch over Setpoint 1/2 and Pband 1/2 When programming this function, "Setting" additionally lists the parameter: "2Pband2 for control circuit 2."

9.10.2.2 Enable ON/OFF function 1D

Remote ON/OFF by potential-free contact.

Activation of the members (speed setting) by analogue output and MODBUS interface is switched off, the other signal inputs and outputs stay active.

The device can still be operated in the switched-off state after pressing the "Esc" key combination.

- A programmed operating indicator relay (factory set "K1 function" = 1K) reports the switch-off.
- A programmed alarm relay (factory set "K2 function" = 2K) does not report the switch-off.

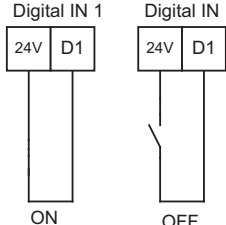
<p>Info [STOP]</p>  <p>Display for switch-off alternately with actual value display</p>	<p>Display STOP for switch OFF</p> <ul style="list-style-type: none"> • Controller "OFF" with opened contact • Controller "ON" for closed contact (factory setting). <p>At "D1 Inverting" = "ON" reversed function, i.e. device "OFF" when contact closed.</p>	 <p style="text-align: right; font-size: small;">25.06.2007 v_1d_24v_freigabe.vsd</p> <p>Contact at digital input e.g. "Digital In 1"</p>
--	---	--





Attention!

No disconnection (isolation) when turned off, in accordance with VBG4 §6!

9.10.2.3 External message, Function 2D

Connecting an external alarm indication (via floating contact). The device continues to work unchanged during an external indication to the digital input; the alarm symbol appears in the display. This indication can be issued via the relay contacts (K1 K2) (☞ IO Setup function K1, K2).

Info 	<ul style="list-style-type: none"> • Indication during closed contact (factory setting): "D1 Inverting" = "OFF " • Indication during opened contact: "D1 Inverting" = "ON"
 External error	Alternative display texts for error message ☞ Controller Setup / display text for external message.
Display alternating with actual value display	

9.10.2.4 Limit ON / OFF, Function 3D

The value for "Limit" adjusted in the Controller Setup, is activated over a digital input. Contact e.g. at digital input "Digital In 1" (depending on device type at terminals "D1" - "D1" or "D1" - "24 V").

For "D1 Inverting" = "OFF", limitation active at closed contact.

The limitation influences both outputs in operation with two control circuits.

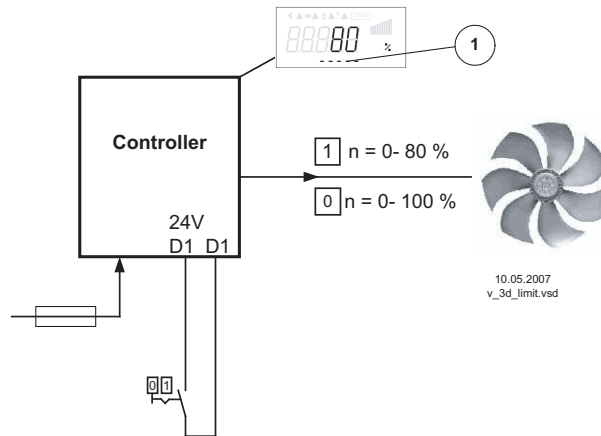

1 Setting "Limit" (depending on device type in: %, Hz, rpm)

9.10.2.5 Switch over input “E1” / “E2”, function 4D
(operation with one control circuit)

Switch over between Input signal 1 (Analog In 1 terminal “E1”) and input signal 2 (Analog In 2 terminal “E2”).
 Contact e.g. at digital input “Digital In 1” (depending on device type at terminals “D1” - “D1” or “D1” - “24 V”).

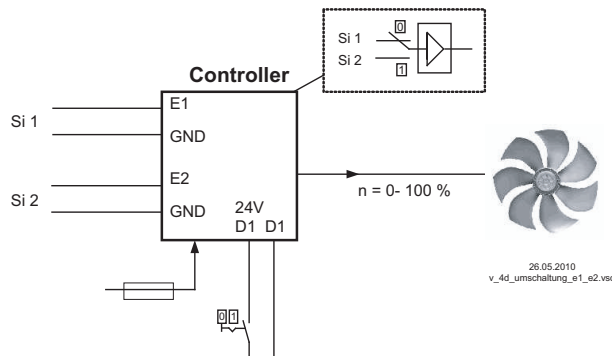

Si 1 Signal 1
 Si 2 Signal 2

For mode speed controller (1.01) Base setup for “E2 Analog In”: 1E necessary.
 For modes controller (from 2.01 ..) Base setup for “E2 Analog In”: 7E necessary (as far as otherwise does not occupy).

9.10.2.6 Output control circuit 2 additional to “A2” on “A1”, function 4D

The output for control circuit 2 is set additionally to “A2” to “A1” (regardless of the programmed function for A1). Control circuit 1 has no output for the duration of the switching.
 Contact e.g. at digital input “Digital In 1” (depending on device type at terminals “D1” - “D1” or “D1” - “24 V”).
 At “D1” Inverting “OFF” the output of control circuit 2 also influences output “A1” when the contact is closed.

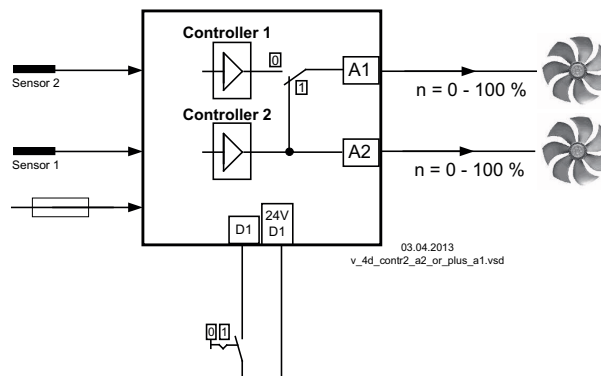

9.10.2.7 Set 1/2 or Setpoint 1/2, Function 5D
For Mode Speed controller 1.01: Switch over “Set Intern1” / “Set Intern2”

Contact e.g. at digital input “Digital In 1” (depending on device type at terminals “D1” - “D1” or “D1” - “24 V”).

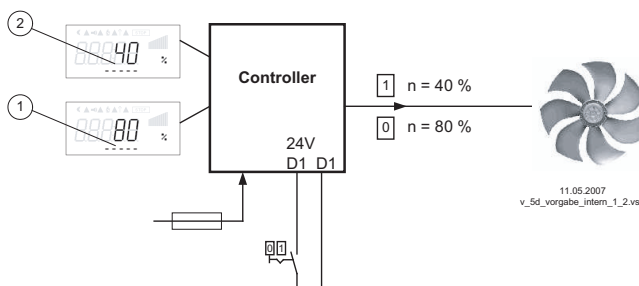

- “D1 Inverting” = “OFF”: “Set Intern1” at opened contact / “Set Intern2” at closed contact.
- “D1 Inverting” = “ON”: “Set Intern1” at closed contact / “Set Intern2” at opened contact.

1 Setting “Set Intern1” (depending on device type in: %, Hz, rpm)
 2 Setting “Set Intern2” (depending on device type in: %, Hz, rpm)

<p>Info</p>	<p>Operation with "Set Intern2" is signaled by the moon symbol for reduced operation. "Set extern1" under "settings" must be programmed to "OFF".</p>
<p>50 % Modulation</p>	

For operation as controller (starting from 2.01): switch over "Setpoint 1" / "Setpoint 2"
For operation with second control circuit: switch over "1.Setpoint 1" / "1.Setpoint 2"

Contact e.g. at digital input "Digital In 1" (depending on device type at terminals "D1" - "D1" or "D1" - "24 V").

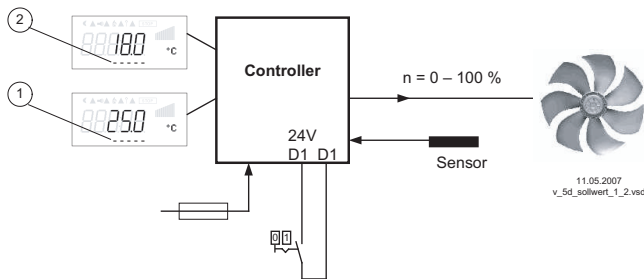

- "D1 Inverting" = "OFF": "Setpoint1" = 18 °C at opened contact / "Setpoint2" = 25 °C at closed contact.
- "D1 Inverting" = "ON": "Setpoint1" = 18 °C at closed contact / "Setpoint2" = 25 °C at opened contact.

- 1 Setting "Setpoint 1" or "1.Setpoint 1" (display in operation with two control circuits for Setpoint 1 of control circuit 1)
- 2 Setting "Setpoint 2" or "1.Setpoint 2" (display in operation with two control circuits for Setpoint 2 of control circuit 1)

<p>Info</p>	<p>Operation with "Setpoint2" is signaled by the moon symbol for reduced operation.</p>
<p>28.7 °C E1 Actual</p>	

9.10.2.8 Intern / Extern Function [6D]

For Mode Speed controller 1.01: Switch over "Set Intern" / "Set external"

"Set extern1" under settings must be programmed to "OFF".

Contact e.g. at digital input "Digital In 1" (depending on device type at terminals "D1" - "D1" or "D1" - "24 V").

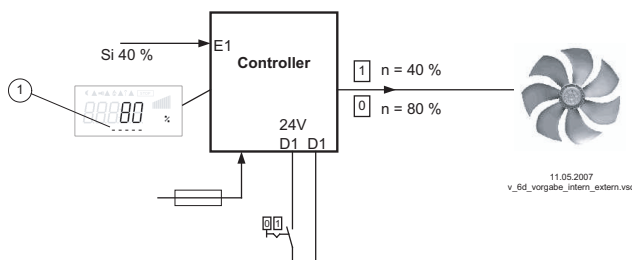

- "D1 Inverting" = "OFF": "Set Intern1" at opened contact / "Setting Extern" at closed contact.
- "D1 Inverting" = "ON": "Set Intern1" at closed contact / "Set Extern" at opened contact.

- Si Signal
 1 Setting "Set Intern1" (depending on device type in: %, Hz, rpm)

For operation as controller (starting from 2.01): switch over "Setpoint 1" / "external Setpoint"

Possible only for operation with one control circuit!

Under Base setup "E2 function" programmed to function [1E] for "external setpoint".

Contact at digital input e.g. "Digital In 1" = "D1" - "D1"

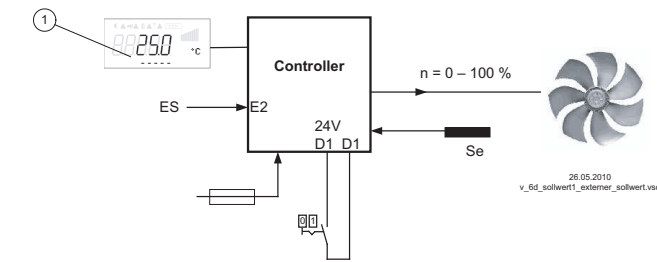

- “D1 Inverting” = “ON”: Setting at the unit at opened contact / Signal Extern at closed contact
- “D1 Inverting” = “OFF”: Setting at the unit at closed contact / Signal Extern at opened contact

1 Setting “Setpoint1”
 ES External Setpoint e.g. 5 V Δ 23.8°C
 Se Sensor

9.10.2.9 Automatic control / speed manual Function [7D] (mode 2.01)

Possible only for operation with one control circuit!

Switch over between automatic control to set target value (depending on the activation: “Setpoint1”, “Setpoint2”) and the default for “manual operation” set at the device.

If for Analog In 2 “E2 function” is programmed to [2E] switch over between “Setpoint1” or “Setpoint2” and external manual operation. With activated manual mode the display constantly changes between “actual value” and value for “manual mode”.

Contact at digital input e.g. “Digital In 1”

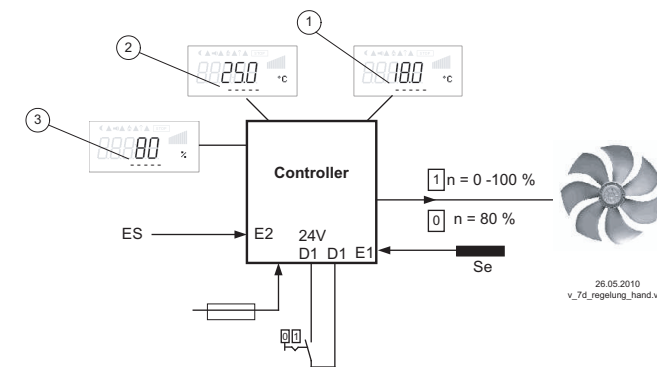

- “D1 Inverting” = “OFF” Automatic control at opened contact / manual operation at closed contact.
- “D1 Inverting” = “ON”: Automatic control at closed contact / manual operation at opened contact.

1 Setting “Setpoint1”
 2 Setting “Setpoint2”
 3 Setting “Speed manual” (depending on device type in: %, Hz, rpm)
 EH Signal for Manual mode extern, E2 Function = [2E]
 Se Sensor

9.10.2.10 Reverse action of control function (2.01), Function [8D]

Switchover between: Increasing modulation during increasing actual-value and increasing modulation during sinking actual-value.

The factory presets for the “Control function” are dependent on the selected mode of operation (Controller Setup - reverse operation of the control function).

When switching over via a digital input, the device works with the opposite function as set there.

The inversion of the control function influences both circuits in operation with two control circuits.

Controller Setup	Settings in Controller Setup
ON Val>Set=n+	Display for operation with two control circuits: “1. Actual>Set=n” for control circuit 1 “2. Actual>Set=n” for control circuit 2

9.10.2.11 Switch over Setpoint 1/2 for control circuit 2 [9D]

Switch over between “2.Setpoint 1” and “2.Setpoint 2” (for operation with two control circuits)

Contact e.g. at digital input “Digital In 1” (depending on device type at terminals “D1” - “D1” or “D1” - “24 V”).

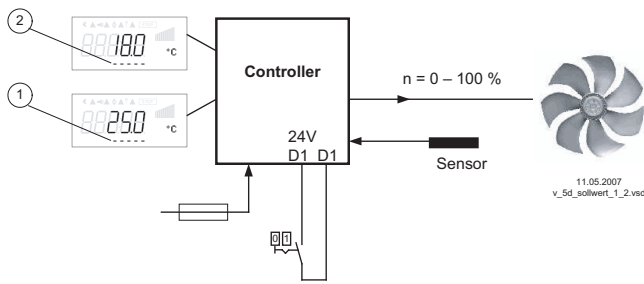

- “D1 Inverting” = “OFF”: “2. Setpoint 1” = 18 °C at opened contact / “2. Setpoint 2” = 25 °C at closed contact.
- “D1 Inverting” = “ON”: “2. Setpoint 1” = 18 °C at closed contact / “2. Setpoint 2” = 25 °C at opened contact.

- 1 Setting “2.Setpoint 1” = Setpoint 1 of control circuit 2
- 2 Setting “2.Setpoint 2” = Setpoint 2 control circuit 2

Info		Operation with “2. Setpoint2” is signaled by the moon symbol for reduced operation. If Setpoint 2 was activated additionally for control circuit 1 “1.Setpoint 2” by a digital input with function [5D] , the moon symbol is already switched on.
28.7 °C E2 Actual		

9.10.2.12 Setting Max. Speed ON / OFF function **[11D]**

The value for “Max Speed” adjusted in menu “Settings”, is activated over a digital input. I.e. the unit works independently of the controller function firm with this value.

Contact e.g. at digital input “Digital In 1” (depending on device type at terminals “D1” - “D1” or “D1” - “24 V”).

This function influences both circuits in operation with two control circuits.

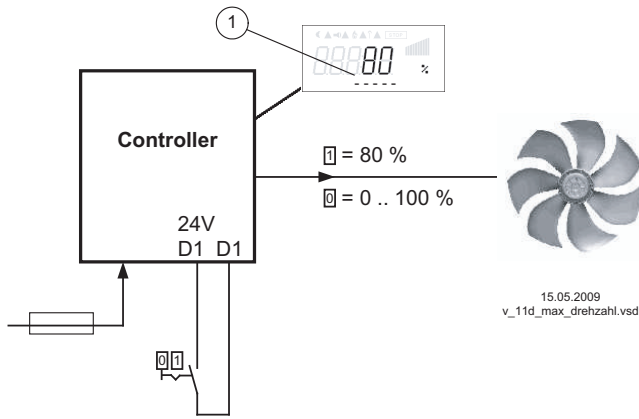

- “D1 Inverting” = “OFF”: “Max. Speed” active at closed contact
- “D1 Inverting” = “ON”: “Max. Speed” active at opened contact

Display depending on device type in: %, Hz, rpm
 1 Setting “Max. Speed” or “1.Max. Speed” and “2.Max. Speed” for operation with two control circuits

9.10.2.13 Switch over Setpoint 1/2 and Pband 1/ 2 for control circuit 1 [15D]

Switching between “1st setpoint 1” / “1st setpoint 2” and “1st Pband 1” / “1st Pband 2” (from 2.01, not for 2.03).

Function basically the same as [5D], it is additionally switched over to Pband 2.

When programming this function, “Setting” additionally lists the parameter: “1.Pband 2 for control circuit 2.”

Contact e.g. at digital input “Digital In 1” (depending on device type at terminals “D1” - “D1” or “D1” - “24 V”).

Example for “D1 Inverting” = “OFF”:

- With open contact: “1.Setpoint 1” = 20 °C + “1.Pband 1” = 5 K
- With closed contact: “1.Setpoint 2” = 17 °C + “1.Pband 2” = 3 K

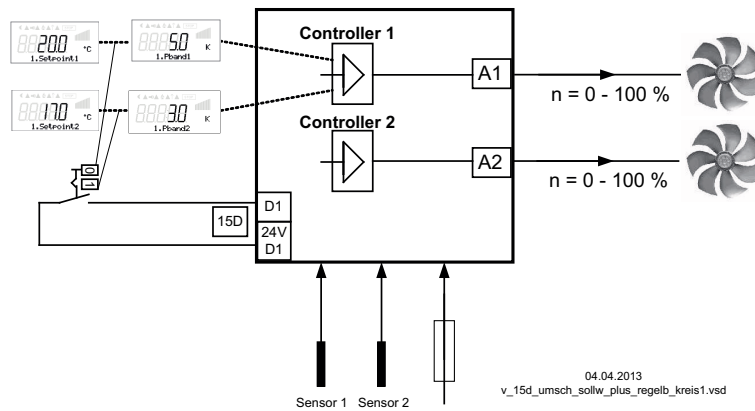

- 1.Setpoint1 Setting “1.Setpoint 1” = Setpoint 1 of control circuit 1
- 1.Pband1 Setting “1.Pband 1” = Pband 1 von control circuit 1
- 1.Setpoint2 Setting “1.Setpoint 2” = Setpoint 2 of control circuit 1
- 1.Pband2 Setting “1.Pband 2” = Pband 1 von control circuit 1

Info	Operation with “1.Setpoint2” and “1.Pband2” is signaled by the moon symbol for reduced operation.
28.7 °C E1 Actual	If Setpoint 2 was activated additionally for control circuit 1 or control circuit 2 by a digital input with function [5D] / [9D] the moon symbol is already switched on. If Setpoint 2 and Pband 2 were activated additionally for control circuit 2 by a digital input with function [16D], the moon symbol is already switched on.

9.10.2.14 Switch over Setpoint 1/2 and Pband 1/2 for control circuit 2 [16D]

Switch over between “2.Setpoint 1” / “2.Setpoint 2” and “2.Pband 1” / “2.Pband 2” (only for operation with second control circuit possible).

Function basically the same as [5D] and [9D], it is additionally switched over to Pband 2.

When programming this function, “Setting” additionally lists the parameter: “2Pband2 for control circuit 2.”

Contact e.g. at digital input “Digital In 1” (depending on device type at terminals “D1” - “D1” or “D1” - “24 V”).

Example for “D1 Inverting” = “OFF”:

- With open contact: “2.Setpoint 1” = 20 °C + “2.Pband 1” = 5 K
- With closed contact: “2.Setpoint 2” = 17 °C + “2.Pband 2” = 3 K

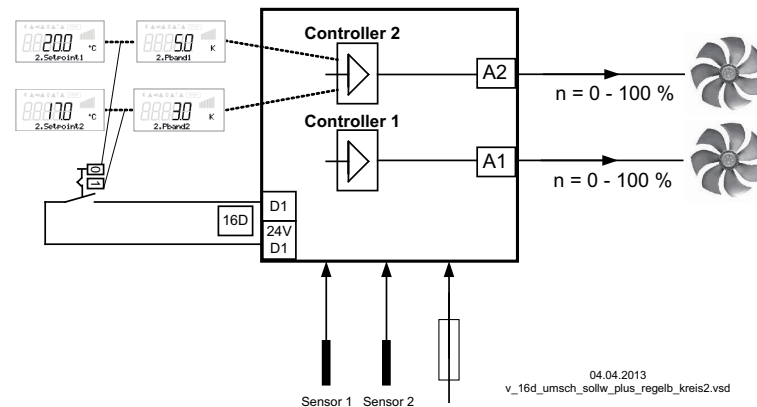

- 2.Setpoint1 Setting “2.Setpoint 1” = Setpoint 1 of control circuit 2
- 2.Pband1 Setting “2.Pband 2” = Pband 1 von control circuit 2
- 2.Setpoint2 Setting “2.Setpoint 2” = Setpoint 2 of control circuit 2
- 2.Pband2 Setting “2.Pband 2” = Pband 2 von control circuit 2

Info	 Operation with “2.Setpoint2” and “2.Pband2” is signaled by the moon symbol for reduced operation.
28.7 °C E2 Actual	If Setpoint 2 was activated additionally for control circuit 1 or control circuit 2 by a digital input with function 5D / 9D the moon symbol is already switched on.
	If Setpoint 2 and Pband 2 was activated additionally for control circuit 1 by a digital input with function 15D , the moon symbol is already switched on.

9.10.2.15 Timer function overwrite **21D**

The timer output can be overwritten for a settable time with a selectable status if required (☞ timer). To overwrite the timer function by pressing keys until the next timing change => “Override Time” = 0 min.

The override time is activated by pressing a key at a digital input (example for D1 not inverted). The bypass time can be ended prematurely by pressing another key.

If the contact remains closed, the override time also run out, then a short interruption is required to reactivate.

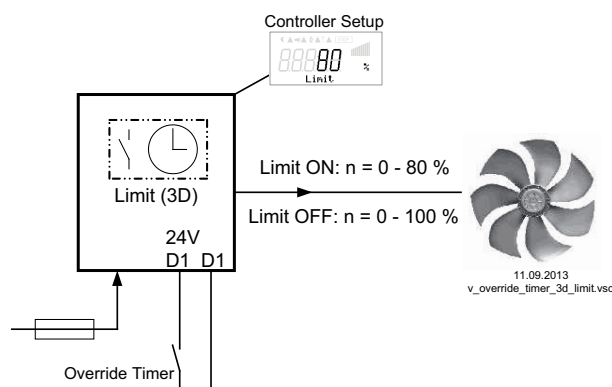

Contact depending on device type at terminals “D1” - “D1” or “D1” - “24 V”

Example: speed limitation over Timer (Function **3D**)

The timer limits the maximum speed for a certain period of time (e.g. timer ON from 6:00 - 10:00 am). With the “Override Timer” contact the limitation (from 6:00 - 10:00 am) activated by the timer can be cancelled for an adjustable period “Override Time” (☞ timer / timer function overwritten: Override Status = OFF)

To activate the limitation outside the programmed time (10:01 - 5:59 am) => “Override Status” = ON

9.10.3 Configuration of analog inputs “E1”and “E2”

9.10.3.1 Signal adaption E1 and E2

If required, an adaptation of the specification signal / speed characteristic curve is possible



Information

Setting options depending on the version of the software available!

These settings are mostly practical for the operating mode with rotational speed specification over an external signal. In operating modes (as of 2.01) this setting is not suited for influencing the regulation process.

IO Setup	
0 E1 Modus	E1 Modus 0 = E1 min. / E1 max. without function (factory setting) 1 = Offset / turn 2 = signal range 3 = Hysteresis setting On / Off (function depending on the version of the software available)
IO Setup	
0 % E1 Min.	E1 Min. Setting range: 0 - 100 % Factory setting: 0 %
IO Setup	
0 % E1 max	E1 max Setting range: 0 - 100 % Factory setting: 100 %
IO Setup	
0 E2 Mode	E2 Mode 0 = E2 min. / E2 max. without function (factory setting) 1 = Offset / turn 2 = signal range
IO Setup	
0 % E2 min.	E2 min. Setting range: 0 - 100 % Factory setting: 0 %
IO Setup	
0 % E2 max.	E2 max. Setting range: 0 - 100 % Factory setting: 100 %

Example for Mode “1.01” with speed setting signal 0 - 10 V

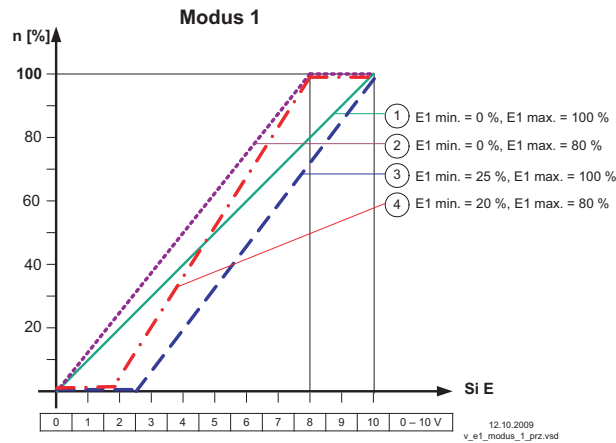

Modus 1

Example: “E1 min.” = 20 %
 The controller begins only at approx. 20% higher signal with minimal modulation.

Example: “E1 max.” = 80 %
 The modulation rises linear to 100% modulation with 80% setting signal.

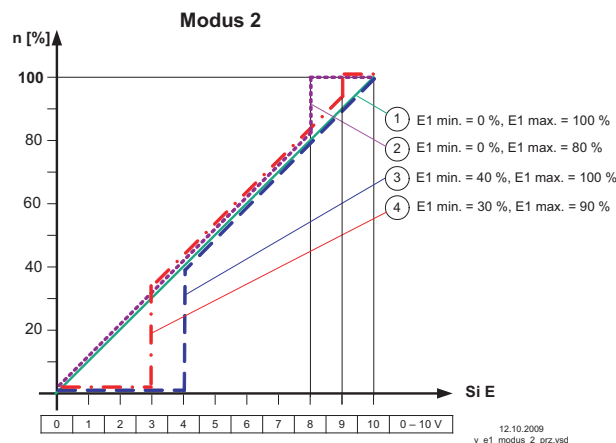

Modus 2

Example: “E1 min.” = 30 %
 Only with approx. 30 % setting signal the controller begins with approx. 30% modulation.

Example: “E1 max.” = 80 %
 Over 80 % setting signal the modulation is switched to 100 % modulation.

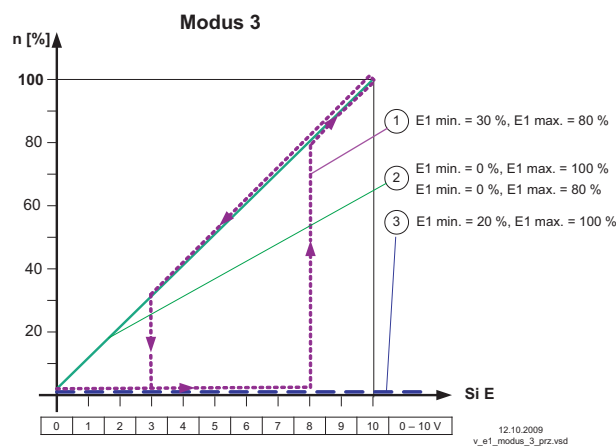

Modus 3

Example: “E1 min.” = 30 %, “E1 max.” = 80 %
 Over approx. 80 % setting signal the modulation is switched on.
 Below approx. 30 % setting signal the modulation is switched off.

For a correct function: E1 min. higher 0 % and E1 max. below 100 %.
 example 2 and 3 only for information.

Idealized principle diagrams for setting:
 “Min. Speed” = 0 % and “Max. Speed” = 100 %

9.10.3.2 Inverting analog inputs “E1” / “E2”

After programming the signal or sensor type, an inversion of the inputs can be carried out.

IO Setup	Factory setting for Inverting inputs = “OFF” (if input activated) (signal: 0 - 10 V, 0 - 20 mA, 4 - 20 mA). For activation using inverted default signals or sensors with inverted output signals proportional to the measurement range, switch inverting to “ON” (Signal: 10 - 0 V, 20 - 0 mA, 20 - 4 mA).
OFF E1 Inverting	
IO Setup	
OFF E2 Inverting	

Example: mode **1.01** speed controller, setting by external signal

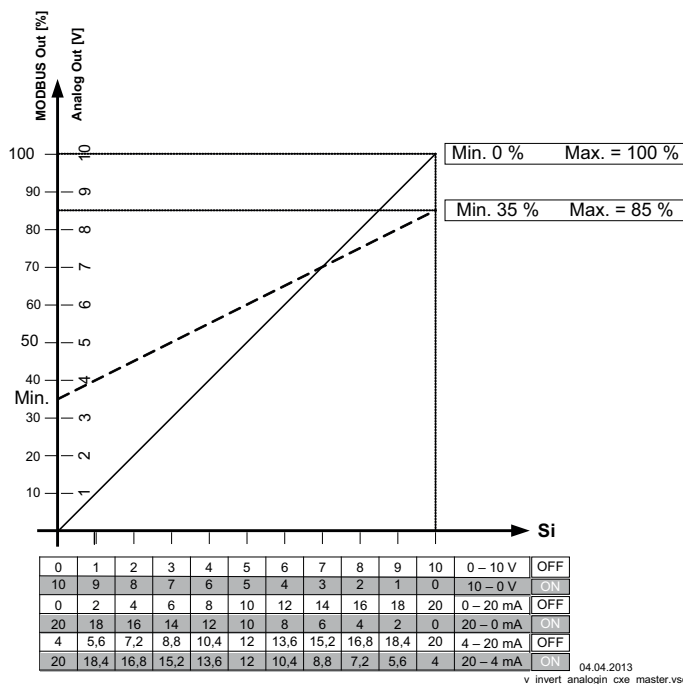

MODBUS Out: speed setting over MODBUS
 Analog Out: speed setting over analog output 0 - 10 V
 Si Signal
 OFF Inverting = OFF
 ON Inverting = ON

9.10.3.3 “E1” / “E2” Bus mode

After programming the signal or sensor type, the raw value (0-32767) of an analog sensor input can be written in a Holding Register (h9000 for E1 and h9001 for E2) with the bus mode activated. The connection is made at the MODBUS RTU Slave interface. Connecting terminals: 2A (2D+), 2B (2D-).

IO Setup	The bus mode of the inputs is set to “OFF” at the factory. With activated bus mode, the raw values can be written accordingly into the Holding Registers, addresses h9000 and h9001 for “E1” and “E2”.
OFF E1 Busmode	
IO Setup	
OFF E2 Busmode	

9.10.4 Function and inverting for relay outputs “K1” and “K2”

IO Setup	<p>Various functions can be allocated to the relay outputs “K1” and “K2”. In case of the same function allocation for “K1” and “K2”, these work parallel.</p> <p>The inversion of the relays “K1” and “K2” is set at the factory to “OFF” (when a function is programmed).</p> <p>For switching inversion to “ON” (switching behaviour dependent on assigned function). The relays can only pull up basically when the voltage supply of the electronics is working. Three-phase current devices must have at least 2 line phases!</p>
Operating indication (1K) K1 Function	
OFF K1 Inverting	
IO Setup	
Fault indication (2K) K2 Function	
IO Setup	
OFF K2 Inverting	

Function	Description
OFF	No function Relays remain always de-energized.
Operating indication (1K)	Operating indication (factory setting for “K1”, non inverting). Operation without fault, reports enable “OFF”
Fault indication (2K)	Fault indication (factory setting for “K2”, non inverting). Pulled up in operation without fault, with release “OFF” not dropped out. Drops out in case of line and device fault and external fault at the digital input. Depending on programming in event of sensor failure. When networked via the MODBUS Master interface, fault indication in case of faulty MODBUS connection and fault on a member.
External error (3K)	External fault separate with message at digital input (factory setting if terminals bridged).
Limit modulation (4K)	Limit modulation Over or falling below limits for modulation.
Limit E1 (5K)	Limit “E1” Whenever or falling below limits for input signal “E1”.
Limit E2 (6K)	Limit “E2” Whenever or falling below limits for input signal “E2”.
For modes as controller (from 2.01.)	
Setpoint Offset (7K)	Limit: Setpoint offset (only for active Setpoint control circuit 1). Deviation between actual value and setpoint to high.
Group2 (8K)	Group control (Group 2) Switching on fans depending on modulation
Group3 (12K)	Group control (Group 3) Switching on fans depending on modulation
Group4 (14K)	Group control (Group 4) Switching on fans depending on modulation
For modes as temperature controller with additional functions 2.03	
2.Heating (9K)	Heating function Switch ON point: temperature = Setpoint +/- Offset Switch OFF point: Temperature around hysteresis over switch ON point
2.Cooling (10K)	Cooling function Switch ON point: temperature = Setpoint +/- Offset Switch OFF point: Temperature around hysteresis below switch ON point

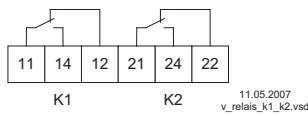

- K1** 1 = energized, terminals 11-14 bridged
 0 = de-energized, terminals 11-12 bridged
- K2** 1 = energized, terminals 21-24 bridged
 0 = de-energized, terminals 21-22 bridged

Function	Controller status	K1/ K2	
		1 = energized 0 = de-energized	
		Inverting	
		OFF	ON
1K	Operation without fault, line supply okay	1	0
2K	Fault with indication by relay	0	1
3K	External Fault at digital input for external fault	1	0
4K	Over or falling below modulation	1	0
5K	over or falling below limits for input signal "E1"	1	0
6K	over or falling below limits for input signal "E2"	1	0
7K	setpoint deviation to high	1	0

9.10.5 COM2 Function

IO Setup	Possible settings:
MODBUS Slave COM2 Function	<ul style="list-style-type: none"> • MODBUS Slave (factory setting): In the main menu the "Diagnostic" menu group is followed by the "MODBUS Slave" menu group. The communication parameters can be set in this. • OFF: The "MODBUS Slave" or "MODEM SMS" menu group is not displayed in the main menu. • MODEM SMS: In the main menu the "IO Setup" menu group is followed by the "MODEM SMS" menu group. Input SIM PIN for MODEM SMS interface (no function at present).

9.11 Limits

9.11.1 Limit indication depending on modulation

only for Modulation control circuit 1!

Display for operation with two control circuits: 1.Modul. function, 1.Modulation min., 1.Modulation max., 1.Modul. Delay

Limits	Following functions can be allocated to the limit indication	
OFF Controller function	OFF	none Function (factory setting)
	Failure (1L)	Limit alarm alternating with actual value display Is listed in the protocol as an alarm. Indication with the centralized fault of a programmed relay (IO allocation Function [2K]).
	Message (2L)	Is listed in the protocol as a message. There is no alternating message on the actual value display and no message via alarm relay.
	Filter error (3L)	Like function [1L] with fault message "Filter"
	Filter Message (4L)	Like function [2L] with fault message "Filter"
In the IO setup, a separate relay can be allocated independent of these settings.		
Limits	If the modulation exceeds the set "Level max" value, this is reported until the set value "Level min" has been undercut.	
30 % Level min.	The indication is delayed by the time set in "Display delay". Setting range: 0 - 100 % Factory setting: 30 % / 40 % *	
Limits		
40 % Level max.		
Limits	Time delay exceeding "Level max." up to indication by relay and alarm symbol.	
2 sec Level Delay	Setting range: 0 - 120 sec. Factory setting: 2 sec. *	

* Display [----] as long as function = OFF

Example indication by relay “K1”:

not inverted

IO Setup: K1 Function = 4K
IO Setup: K1 Inverting = OFF

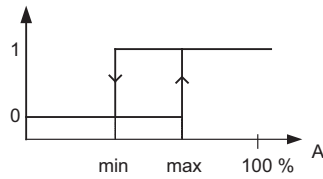

Inverting

IO Setup: K1 Function = 4K
IO Setup: K1 Inverting = OFF

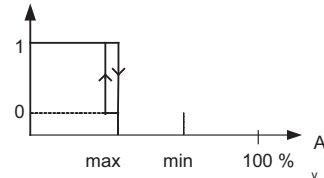
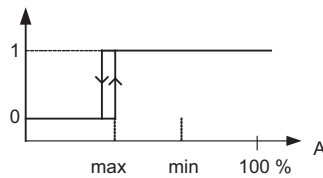
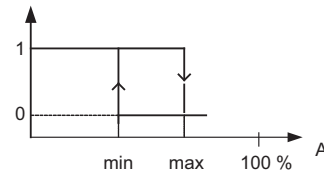

A Modulation

If “Level min.” is higher than “Level max.”, the “Level max.” switching point is without hysteresis.

9.11.2 Limit indication depending on setting or sensor signal

Same procedure for analogue inputs “E1” and “E2”.

Limits	Following functions can be allocated to the limit indication	
OFF Lmt E1 Function	OFF	none Function (factory setting)
	Failure (1L)	Limit alarm alternating with actual value display is listed in the protocol as an alarm. Indication with the centralized fault of a programmed relay (IO allocation Function [2K]).
	Message (2L)	Is listed in the protocol as a message. There is no alternating message on the actual value display and no message via alarm relay.
	Filter error (3L)	Like function [1L] with fault message “Filter”
	Filter Message (4L)	Like function [2L] with fault message “Filter”
In the IO setup, a separate relay can be allocated independent of these settings.		
Limits	Both values for E1 (“E1 min” and “E1 max”) can be set independent of each other and act on a relay together if correspondingly programmed. If a function is activated or if a relay is allocated, both settings (“min” and “max”) are initially at “OFF”. Work can be carried out with one as well as with both limit indicators. The same setting applies to “E2 Min.” and “E2 Max.”, described below for “E1”.	
----- Lmt E1 min	Undercutting the signal (“E1 min”).	
Limits	If the signal undercuts the set value “E1 min”, this is reported until the set value (plus adjustable hysteresis) has been exceeded once again.	
----- Lmt E1 max.	Exceeding the signal (“E1 max”).	
Limits	If the signal exceeds the set value “E1 max”, this is reported until the set value (minus hysteresis) has been undercut once again.	
Limits	E1 Hysteresis	
----- Lmt E1 Hyst.	Hysteresis adjustment in the unit of measure of the programmed input signal.	

Limits	E1 Delay
----- Lmt E1Del.	Time delay exceeding "Level max." up to indication by relay and alarm symbol. Setting range: 0 - 120 sec. Factory setting: 2 sec.



Information

Always adjust the value for the maximum input signal higher than the value for the minimum input signal!
E1 Max. > E1 Min.

Example for a limit indication of default signal or sensor signal to "Analog In 1"

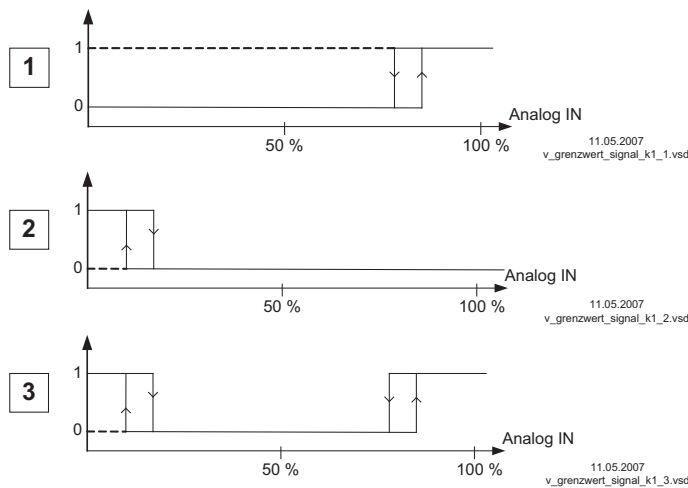

Settings:

- E1 Max.: 80 %
- E1 Min.: OFF
- switching hysteresis 5 % (from 100 %)

Settings:

- E1 Min.: 20 %
- E1 Max.: OFF
- switching hysteresis 5 % (from 100 %)

Settings:

- E1 Min.: 20 %
- E1 Max.: 80 %
- switching hysteresis 5 % (from 100 %)

Terminal "E1" and "GND" alarm via relay "K1" (non-inverted) IO Setup → K1 function: **[5 K]** = limit indicators

9.11.3 Limit indication depending on (offset) to Setpoint

In operating modes as a controller (starting from **2.01**), two limit indicators can be carried out based on the set target value (Setpoint) and measured actual value (on E1).

Only for active Setpoint of control circuit 1!

Display for operation with two control circuits: 1.Offset function, 1.Offset 1, 1.Offset 2, 1.Offset hyst., 1.Offset Delay

Limits	Following functions can be allocated to the limit indication. Identical setting for both analogue inputs "E1" and "E2".	
OFF Offset Function	OFF	none Function (factory setting)
	Failure (1L)	Limit alarm alternating with actual value display is listed in the protocol as an alarm. Indication with the centralized fault of a programmed relay (IO allocation Function 2K).
	Message (2L)	Is listed in the protocol as a message. There is no alternating message on the actual value display and no message via alarm relay.
	Filter error (3L)	Like function 1L with fault message "Filter"
	Filter Message (4L)	Like function 2L with fault message "Filter"
	In the IO setup, a separate relay can be allocated independent of these settings.	
Limits	Offset 1, Offset 2	
----- Offset 1	Both values for Offset 1 and Offset 2 can be set independent of each other and act on a relay together if correspondingly programmed. If a function is activated or if a relay is allocated both settings (Offset 1 and Offset 2) are initially at "OFF". Work can be carried out with one as well as with both limit indicators.	
Limits	"Offset 1" for alarm in case of an exceeding of the max. deviation between actual and target.	
----- Offset 2	Switch ON point: actual value = Setpoint +/- offset Switch OFF point: Actual value by hysteresis under the switch-on point	
	"Offset 2" for alarm in case of an undercutting of the max. deviation between actual and target	
	Switch ON point: actual value = Setpoint +/- offset Switch OFF point: Actual value by hysteresis over the switch-on point	
Limits	Offset Hysteresis	
----- Offset Hyst.	Hysteresis switch-on point: In temperature regulation +/- 10 K, otherwise sensors 10 % of measurement range	
Limits	Offset Delay	
----- Offset Delay	Time delay until indication through relay and alarm symbol. Setting range: 0 - 120 sec. Factory setting: 2 sec.	

Example for temperature regulation; for other modes of operation settings in corresponding sensor unit.

Offset 1 for alarm during exceeding

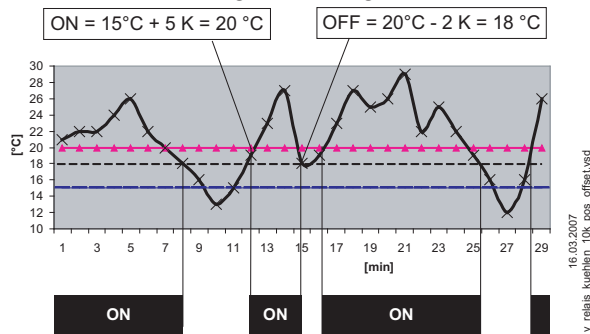

Example: Setpoint 15.0 °C, Offset +5.0 K, Hysteresis 2.0 K

Offset 2 for alarm during undercutting

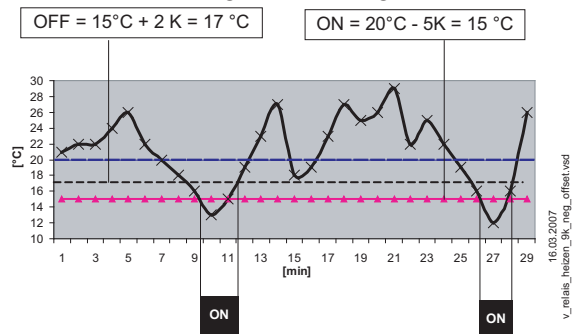

Example: Setpoint 15.0° C, Offset -5.0 K, Hysteresis 2.0 K

9.12 Timer

9.12.1 Timerfunction

The device has a real time clock. The clock is backed up (Gold Cap) and has a reserve of 2 or 3 days after sufficient operation on a voltage supply.

The time and date must be set during start-up operation and when using the real-time clock. The device calculates the weekday based on the date.

In principle, the timer function acts like a digital switch input (timer “On” $\hat{=}$ closed contact at inverting OFF). The same functions can be assigned to the timer switch as the digital inputs(“D1 ..D2”).

Function	Description *	Timer ON = (@ Timer Invert. = OFF) 
OFF	No function (factory setting)	
Enable (1D)	Enable (remote control) “ON” / “OFF”	Device ON
External error (2D)	External fault alarm	Failure
Limit (3D)	“Limit” ON / OFF Influences control circuit 1 and control circuit 2 in operation with two control circuits	Limit ON
E1 / E2 (4D)	Switch over input “E1” / “E2” (for operation with one control circuit)	Signal at E2
Reset (10D)	Complete re-start of the device	Reset
Max. Speed (11D)	Setting Max. Speed “ON” / “OFF” Influences the respectively set value “1. Max. Speed” and “2. Max. Speed” in operation with two control circuits.	Max. Speed ON
Override Time (21D)	Do not use function for timer (only for digital input).	-
For mode speed controller 1.01		
Setpoint1/2 (5D)	Switch over “Set Intern1” / “Set Intern2” “Setting External 1” must be at “OFF”.	Set Intern2
Setpoint int./ext. (6D)	Switch over “Intern” / “Extern”	Set extern
For modes as controller (from 2.01)		
Setpoint1/2 (5D)	Switch over “Setpoint 1” / “Setpoint 2”for control circuit1	Setpoint2

Function	Description *	Timer ON = (@ Timer Invert. = OFF) 
Setpoint int./ext. (6D)	Switch over "Intern" / "Extern" Possible only for operation with one control circuit!	Setpoint External
Control/Manual (7D)	Switch over "automatic control" / "Speed manual" Possible only for operation with one control circuit!	Manual mode
Heating/Cooling (8D)	Switch over control function (e.g. "heating" / "cooling")	Reversal standard
1.Setp+Pband1/2 (15D)	for control circuit 1: Switch over Setpoint 1/2 and Pband 1/1 When programming this function, "Setting" additionally lists the parameter: "1.Pband2 for control circuit 1."	First control circuit Setpoint 2 + Pband 2
	Only active in operation with a second control circuit!	
E1 / E2 (4D)	The output for control circuit 2 is additionally set to "A2" to "A1" (regardless of the programmed function for "A1"). The first control circuit has no output for the duration of the switch over. The switch over input "E1" / "E2" as in operation with one control circuit is no longer possible.	Second control circuit to A1 + A2
2. Setpoint 1/2 (9D)	for control circuit 2: Switch over "2. Setpoint 1" / "2. Setpoint 2"	Second control circuit Setpoint 2
2.Setp+Pband1/2 (16D)	for control circuit 2: Switch over Setpoint 1/2 and Pband 1/2 When programming this function, "Setting" additionally lists the parameter: "2Pband2 for control circuit 2."	Second control circuit Setpoint 2 + Pband 2

* Detailed description  IO Setup / Digital Inputs "D1" / "D2"

Example: Programming limitation for output voltage (Limit ON / OFF)

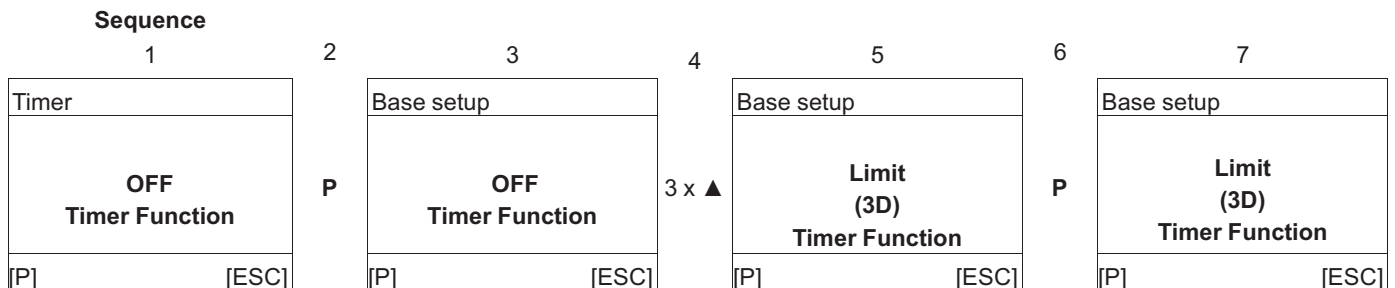

Controller Setup	
IO Setup	
Limits	
Timer	
Autoaddressing	
Timer	Press the P-key and set the hours with the UP / DOWN keys, press the P-key to save.
13:05 Time	Now the minutes flash and can be set with the UP / DOWN keys, press the P-key to save.
Timer	To set the date follow the same method as for "Time". The date setting consists of day, month and year
09.04.13 Date	Example for: 9. April 2013

9.12.3 Automatic summer time

The summertime automatic is factory set to "OFF", i.e. switched off. When the summertime automatic is activated the device automatically switches between daylight saving time and wintertime. "North" = for countries in the Northern Hemisphere. "South" = for countries in the Southern Hemisphere.

		for Northern Hemisphere		for Southern Hemisphere
Timer		Timer		Timer
OFF Summertime Auto.	→	North Summertime Auto.		South Summertime Auto.



Information

If the summer time automatic is used, the switch over date and the switch over time are identical and unchangeable for both settings.

The time is put forward from 2:00 am to 3:00 am respectively on the last Sunday in March (South put back from 3:00 am to 2:00 am) and put back from 3:00 am to 2:00 am (South put forward from 2:00 am to 3:00 am) on the last Sunday in October.

If other dates for the switch over between summer time and winter time are required, the clock must be changed by hand (manually) on the respective date.

9.12.4 Enter switching times

Two switching times can be entered for the same function (e.g. **3D** = Limit) for each weekday. The menu items are repeated for each weekday with two on- and off-times each. Switching times are not preprogrammed at the factory.

In order to make configuration easier, the same switching times can be made for several days in a block. To prevent unwanted switching times from arising, all should be deleted before programming. To do this, select the block **Mo - Su** and deactivate all 4 switching times.

Be sure to delete all switching times before carrying out complete new settings.

Sequence		1	2	3	4	5	6	7
		Timer		Timer		Timer		Timer
		Mon	P 9 x ▲	Mon-Sun	P	----- Mon-Sun ON1	3 x P	----- Mon-Sun OFF1
		[P] [ESC]		[P] [ESC]		[P] [ESC]		[P] [ESC]
		Factory setting first weekday *		All weekdays selected		First switch-on time for all weekdays. Display: [----] = no switching times programmed yet.		The first switching times for all weekdays are now deleted. Then the first switch-off time for all weekdays is displayed. Now delete all other switching times in the same way.

* If switching times are already programmed for all weekdays "Mon-Sun", press the P key and increase the hours with the ▲-key until the deactivation appears after "23", display: [----]. Then press the P key twice to confirm and delete the switching times.

All programmed switching times are deleted after loading the factory setting or resetting the mode.

Factory setting without preprogrammed switching times

Mon-Sun													
Mon-Fri										Sat-Sun			
Mon	Tue	Wed	Thr	Fri	Sat	Sun							
ON1	--:--	ON1	--:--	ON1	--:--	ON1	--:--	ON1	--:--	ON1	--:--	ON1	--:--
OFF1	--:--	OFF1	--:--	OFF1	--:--	OFF1	--:--	OFF1	--:--	OFF1	--:--	OFF1	--:--
ON2	--:--	ON2	--:--	ON2	--:--	ON2	--:--	ON2	--:--	ON2	--:--	ON2	--:--
OFF2	--:--	OFF2	--:--	OFF2	--:--	OFF2	--:--	OFF2	--:--	OFF2	--:--	OFF2	--:--

Example 1: Every day at 8 am ON and at 6 pm OFF

Mon-Sun													
ON1	08:00	ON1	08:00	ON1	08:00	ON1	08:00	ON1	08:00	ON1	08:00	ON1	08:00
OFF1	18:00	OFF1	18:00	OFF1	18:00	OFF1	18:00	OFF1	18:00	OFF1	18:00	OFF1	18:00
ON2	--:--	ON2	--:--	ON2	--:--	ON2	--:--	ON2	--:--	ON2	--:--	ON2	--:--
OFF2	--:--	OFF2	--:--	OFF2	--:--	OFF2	--:--	OFF2	--:--	OFF2	--:--	OFF2	--:--

Example 2: Monday to Friday at 6 am ON at 8 am OFF and at 5 pm ON at 10 pm OFF

Mon-Fri										Sat-Sun			
ON1	06:00	ON1	06:00	ON1	06:00	ON1	06:00	ON1	06:00	ON1	--:--	ON1	--:--
OFF1	08:00	OFF1	08:00	OFF1	08:00	OFF1	08:00	OFF1	08:00	OFF1	--:--	OFF1	--:--
ON2	17:00	ON2	17:00	ON2	17:00	ON2	17:00	ON2	17:00	ON2	--:--	ON2	--:--
OFF2	22:00	OFF2	22:00	OFF2	22:00	OFF2	22:00	OFF2	22:00	OFF2	--:--	OFF2	--:--

Example 3: Wednesday 6 pm ON and Thursday at 8 am OFF

Mon	Tue	Wed	Thr	Fri	Sat	Sun							
ON1	--:--	ON1	--:--	ON1	18:00	ON1	--:--	ON1	--:--	ON1	--:--	ON1	--:--
OFF1	--:--	OFF1	--:--	OFF1	--:--	OFF1	08:00	OFF1	--:--	OFF1	--:--	OFF1	--:--
ON2	--:--	ON2	--:--	ON2	--:--	ON2	--:--	ON2	--:--	ON2	--:--	ON2	--:--
OFF2	--:--	OFF2	--:--	OFF2	--:--	OFF2	--:--	OFF2	--:--	OFF2	--:--	OFF2	--:--

Free tables for entering individual timer settings

Mon	Tue	Wed	Thr	Fri	Sat	Sun							
ON1		ON1		ON1		ON1		ON1		ON1		ON1	
OFF1		OFF1		OFF1		OFF1		OFF1		OFF1		OFF1	
ON2		ON2		ON2		ON2		ON2		ON2		ON2	
OFF2		OFF2		OFF2		OFF2		OFF2		OFF2		OFF2	

9.12.5 Inverting timer function

Inverting of the timer function is possible if required.

Timer	Timer Inverting
OFF Timer Inverting	In the "OFF" setting (factory setting), the programmed function is activated at the switch-on time (clock icon in the display) and deactivated again at the switch-off time (☞ timer function). In the "ON" setting, the programmed function is deactivated at the switch-on time and activated again at the switch-off time (clock icon in the display).

9.12.6 Overwrite timer function

The timer output can be overwritten for a settable time with a selectable status if required. Activation is by a digital input (☞ IO Setup function [21D])

Application: Exceptions from the normal timing operation, e.g. for manual or automatic presence switch, party mode, etc.

Timer	Override Time
120 min Override Time	Settable time for overwriting the timer function Setting range: 0...65535 min. Factory setting: 120 min
	In the "0 min." setting, the timer function is overwritten with the selected status until the next timing change.
Timer	Override Status
OFF Override Status	Settable status when overwriting the timer function: ON = function as for timer ON ☞ timer function OFF = function as for timer OFF (factory setting)

9.12.7 Adjustment of the real time clock

Timer	Fine adjustment of the real time clock is possible if required.
60 RTC Adjust	The greater the value, the slower the clock runs. If the value is increased by one point, this corresponds to a slowing of the clock by approx. 2 to 3 s per month. Setting range: 0 - 127 Factory setting: 60

9.13 MODBUS Slave

Addressing and configuration of the MODBUS Slave interface.

Via this interface the device can be networked with a master building control system, the device then operates as a pure Slave and uses the MODBUS-RTU protocol.

The connection is made to the terminals "2A (2D+)", "2B (2D-)" of the MODBUS Slave interface (☞ installation / RS-485 interfaces for MODBUS RTU).



Information

- In the IO Setup the "COM function must be set" to "MODBUS Slave" so that this menu group is displayed (factory setting).
- MODBUS settings (baud rate, parity) are saved after a reset (☞ menu group "Start" -> "Reset" or interrupt voltage supply).

MODBUS Slave	Bus Address
247 Bus Address	The device address is factory set to the highest available MODBUS address: 247. Setting range MODBUS Address: 1 - 247.
MODBUS Slave	Addressing
OFF Addressing	Switch addressing to "ON" before setting "address".
MODBUS Slave	UART Baudrate
19200 UART Baudrate	Setting transfer rate Valid values: 4800, 9600, 19200, 38400, 115200 Factory setting: 19200
MODBUS Slave	UART Mode
8E1 UART Mode	Setting transfer format Valid values: 8O1, 8N1, 8E1 Factory setting: 8E1

9.14 MODBUS Master

Addressing of the members that are activated via the MODBUS Master interface. Addressing can be done automatically by a patented method. It is then no longer necessary to address every single member manually in the network. Alternatively, manual addressing is possible, for which separate components are required for setting the individual member address.



Information

- A **maximum of 32 devices** can be connected. The communication settings are pre-set to 19.2kbd, 8E1 and cannot be changed.
- To ensure activation, the function of the digital input "D1" of the members is automatically set to "OFF" by the MODBUS Master. I.e. any programmed enable function for switching off the member (by a potential-free contact) is no longer active.

Main menu	MODBUS Master
MODBUS Master	After addressing (manual or automatic), the devices are subsequently listed to the "MODBUS Master" menu group (☞ "members MODBUS Master").
Fan 1 (2A)	
Fan 2 (2A)	
Fan 3 (2A)	
[P] Enter	[ESC] Info

9.14.1 Automatic addressing

- The first member (MODBUS address **1**) must be connected to the terminals 1A(1D+) and 1B (1D-), additionally the “ID” connections must be connected (☞ installation / communication / addressing members MODBUS Master interface).
- The members are automatically addressed consecutively according to the installation.
- In order to do the automatic addressing successfully, all the bus members to be addressed must be connected with each other, applied to voltage and switched on.

The automatic addressing can only be done with compatible devices!

Main menu	MODBUS Master
Limits	
Timer	
Diagnostic	
MODBUS Master	
[P] Enter [ESC] Info	
MODBUS Master	<ol style="list-style-type: none"> 1. Press the P-key to open the “MODBUS Master”. 2. Press the P-key to select automatic addressing. 3. Press the P-key to start automatic addressing.
Autoaddressing	
[P] Enter [ESC] Menu	
MODBUS Master	Display while the automatic addressing is in progress.
Addressing Found: 0 In progress	
[P] Repeat [ESC] Cancel	
MODBUS Master	The found members count is displayed at the end of automatic addressing.
Addressing Found: 5 Done	Press the P-key again to repeat the addressing. Exit the menu with the Esc key combination ▼ + ▲.
[P] Repeat [ESC] Cancel	

9.14.2 Manual addressing

The addressing is done manually by a separate hand held terminal or PC software, the corresponding member count must be entered on the MODBUS Master.

- The members are connected to the device by the terminals 1A(1D+) and 1B (1D-) (⚡ installation / communication).
- All bus members must be addressed uniquely, consecutively and starting at address 1. Otherwise communication could be disturbed or no communication can be set up.
- In order to complete the manual addressing successfully, all the bus members to be addressed must be connected with each other, applied to voltage and switched on.

Main menu	MODBUS Master	
Limits		
Timer		
Diagnostic		
MODBUS Master		
[P] Enter	[ESC] Info	
MODBUS Master	Press the P-key to open the “MODBUS Master”.	
Autoaddressing		
[P] Enter	[ESC] Menu	
MODBUS Master	Press the ▼-key to select the “Bus Slavecount” menu.	
0		
Bus Slavecount		
[P] Edit	[ESC] Menu	
MODBUS Master	Press the P-key to open the menu.	
5	Set the correct member count with the ▼ ▲ keys and confirm with the P-key . Exit the menu with the Esc key combination ▼ + ▲.	
Bus Slavecount		
[P] Edit	[ESC] Menu	

Info	Error message when entering too high a member count, alternately with the actual value display.
	
Error MODBUS Com	
Fan: 2	

9.15 Member MODBUS Master

After addressing, (manual or automatic) the members are then listed to the “MODBUS Master” menu group.

Main menu	The function for activation by MODBUS is displayed after the address of the member. The same function is programmed initially for all members after addressing. [1. Control Signal (2A)] . I.e. every member is activated by the output of control circuit 1.
MODBUS Master	
Fan 1 (2A)	
Fan 2 (2A)	
Fan 3 (2A)	
[P] Enter [ESC] Info	

After selection with the ▼ ▲ keys, press the **P-key** to open the State menu of the member (menu content depends on the type of member).

State menu member Example: ECblue fan

Fan 1 (2A)	
ECblue V13.05	← Device type and firmware version
Fan OK!	← Operating state of the member
Speed [rpm 570]	← Speed Actual value (1/min)
Motorcurrent [A] 2.60	← Current consumption
P=0W Level=0%	← Power consumption and modulation of the device
[P] Edit [ESC] Menu	

To set the MODBUS function for the member, press the **P-key**.

Fan 1 (2A)	Press the P-key to open the menu.
1st control signal	Select the desired MODBUS function with the ▼ ▲ keys and save with the P-key . Pre-programmed function [1. Control Signal (2A)] = output of control circuit 1. For example, to activate speed controllers for fans or fans with integrated controller and MODBUS interface.
(2A)	
MB Function	
[P] Edit [ESC] Menu	The programmable functions correspond to the functions for the analogue outputs (☞ IO Setup). <ul style="list-style-type: none"> • For members activated by control circuit 2, function: [2. Control Signal (8A)] • For members activated in groups (function: [5A], [11A], [12A]), the “Group Version” setting must be observed, at factory setting “OFF” there is no activation (☞ Controller Setup)!

Exit the menu with the Esc key combination ▼ + ▲.

10 Menu tables

10.1 Menues of operating modes

Mode	1.01 1.02	2.01 2.03 2.04	2.02	2.05	3.01 3.02	3.03 3.04	4.01 4.02 4.03	5.01 5.02	6.01	User Setting
Parameter	Factory setting									
Info										
Setting direct	1.02 = 80 %									
Setting step ¹	1.02 = 0									
E1-E2 actual				-2.4 °C						
Control value		2.04 = 30.0 °C				12.0 bar 22.6 °C				
E1 Actual		30.0 °C	30.0 °C	30.0 °C	10.0 bar -88.7 °C	10.0 bar -88.7 °C	88.7 Pa	712 m ³ h	0.45 m/s	
E2 Actual		----- 2.04 = 30.0 °C	-----	30.0 °C	-----	10.0 bar -88.7 °C	----- 4.02, 4.03 = 21.0 °C	----- 5.02 = 21.0 °C	-----	
Setpoint1		20.0 °C	5.0 °C	0.0 °C	12.0 bar 35.0°C	12.0 bar 35.0°C	100 Pa	530 m ³ h	0.50 m/s	
1.Setpoint 1 ²										
2.Setpoint 1 ³										
Setpoint control							4.02, 4.03 = 100 Pa	5.02 = 530 m ³ h		
Modulation	1.01 = 0 %	0 %	0 %	0 %	0 %	0 %	0 %	0 %	0 %	
1. Control ²										
1. Control ³		0 %	0 %		0 %	0 %	0 %	0 %	0 %	
Set external1	1.01 = 0 %									
Min. speed cut off		OFF	OFF	OFF	OFF	OFF	OFF	OFF	OFF	
1. Min. speed cut off ²										
2. Min. speed cut off ³										
Start										
PIN input	-----	-----	-----	-----	-----	-----	-----	-----	-----	
Language	GB	GB	GB	GB	GB	GB	GB	GB	GB	
US units	OFF	OFF	OFF	OFF	OFF	OFF	OFF	OFF	OFF	
Reset	OFF	OFF	OFF	OFF	OFF	OFF	OFF	OFF	OFF	
Mode	1.01 1.02	2.01 2.03 2.04	2.02	2.05	3.01 3.02	3.03 3.04	4.01 4.02 4.03	5.01 5.02	6.01	
xxx	9.31	9.31	9.31	9.31	9.31	9.31	9.31	9.31	9.31	
SN:	000005- E45536	000005- E45536	000005- E45536	000005- E45536	000005- E45536	000005- E45536	000005- E45536	000005- E45536	000005- E45536	
Setting										
Set Intern1	1.01 = 80%									
Set Intern2	1.01 = -- ---									
Setting direct	1.02 = 80%									

Mode	1.01	2.01	2.02	2.05	3.01	3.03	4.01	5.01	6.01	User Setting
	1.02	2.03			3.02	3.04	4.02	5.02		
Parameter	Factory setting									
Setting step ¹	1.02 = 0									
Setpoint1 1.Setpoint 1 ²		20.0 °C	5.0 °C	0.0 °C	12.0 bar 35.0°C	12.0 bar 35.0°C	100 Pa	530 m ³ h	0.50 m/s	
Setpoint2 1.Setpoint 2 ²		-----	-----	-----	-----	-----	----- 4.03 = 100 Pa	-----	-----	
Pband 1 1. Pband 1 ²		5.0 K	20.0 K	5.0 K	5.0 bar 7.0 K	5.0 bar 7.0 K	100 Pa	530 m ³ h	0.50 m/s	
1. Pband 2 ⁴		5.0 K	20.0 K	5.0 K	5.0 bar 7.0 K	5.0 bar 7.0 K	100 Pa	530 m ³ h	0.50 m/s	
Min. Speed 1.Min. Speed ²	0%	0%	0%	0%	0%	0%	0%	0%	0%	
Max. Speed 1. Max. Speed ²	100%	100%	100%	100%	100%	100%	100%	100%	100%	
2.Setpoint 1 ³										
2.Setpoint 2 ³										
2. Pband 1 ³										
2. Pband 2 ⁵										
2. Min. Speed ³	0%	0%	0%		0%		0%	0%	0%	
2. Max. Speed ³	100%	0%	100%		100%		100%	100%	100%	
Set external1	1.01 = ON									
Manual mode 1. Manual mode ²		OFF	OFF	OFF	OFF	OFF	OFF	OFF	OFF	
Speed manual 1. Speed man. ²		100%	100%	100%	100%	100%	100%	100%	100%	
Offset AnalogOut		2.03 = 0.0 K								
Pband AnalogOut		2.03 = 2.0 K								
Min. AnalogOut		2.03 = 0%								
Max. AnalogOut		2.03 = 100%								
OffsetDigitalOut		2.03 = - 1.0 K								
Hyst.DigitalOut		2.03 = 1.0 K								
Alarm Minimum		2.03 = 0.0 °C								
Alarm Maximum		2.03 = 40.0 °C								
T-Band SA							4.02 + 4.03 = 30.0 K	5.02 = 30.0 K		
T-Start SA							4.02 + 4.03 = 15.0 °C	5.02 = 15.0 °C		
Min Setpoint							4.02 + 4.03 = 70.0 Pa	5.02 = 700 m ³ h		
Protocol										

Mode	1.01	2.01	2.02	2.05	3.01	3.03	4.01	5.01	6.01	User Setting
	1.02	2.03			3.02	3.04	4.02	5.02		
Parameter	Factory setting									
Base setup										
Mode	1.01	2.01	2.02	2.05	3.01	3.03	4.01	5.01	6.01	
	1.02	2.03			3.02	3.04	4.02	5.02		
E1 Analog In	1.01 = 0 - 10 V	TF	TF	TF	0-30 MBG	0-30 MBG	DSG200	4.01 = DSG200 4.02 + 4.03 = DSG50	0-1 MAL	
Number steps	1.02 = 0									
Step 1 value	1.02 = -- -- (20%)									
Step 2 value	1.02 = -- -- (40%)									
Step 3 value	1.02 = -- -- (50%)									
Step 4 value	1.02 = -- -- (60%)									
Step 5 value	1.02 = -- -- (100%)									
E1 Refrigerant					3.02 = R503	3.04 = R503				
E1 K-Factor								75		
E1 Unit		-----	-----	-----	-----	-----	-----	-----	-----	
E1 Decimals		-----	-----	-----	-----	-----	-----	-----	-----	
E1 Min.		-----	-----	-----	-----	-----	-----	-----	-----	
E1 max		-----	-----	-----	-----	-----	-----	-----	-----	
E1 Offset		149.9 °C	149.9 °C	149.9 °C	0.00 bar 149.9 °C	0.00 bar 149.9 °C	0.0 Pa	0 m ³ h	0.0 m/s	
E2 Function	1.01 = OFF	OFF 2.04 = 4E	OFF	5E	OFF	4E	OFF 4.02 + 4.03 = 6E	OFF 5.02 = 6E	OFF	
E2 Analog In	1.01 = -- ---	----- 2.04 = TF	-----	TF	-----	0-30 MBG	4.02 = TF 4.03 = Bus	5.02 = TF	-----	
E2 Refrigerant						3.04 = R503				
E2 K-Factor ²								-----		
E2 Unit		-----	-----	-----	-----	-----	----- 4.03 = °C	-----	-----	
E2 Decimals		-----	-----	-----	-----	-----	----- 4.03 = 1	-----	-----	
E2 Min.		-----	-----	-----	-----	-----	----- 4.03 = - 35.0 °C	-----	-----	
E2 Max.		-----	-----	-----	-----	-----	----- 4.03 = 65.0 °C	-----	-----	

Mode	1.01	2.01	2.02	2.05	3.01	3.03	4.01	5.01	6.01	User Setting
	1.02	2.03			3.02	3.04	4.02	5.02		
Parameter	Factory setting									
E2 Offset		----- 2.04 = 149.9 °C	-----	149.9 °C	-----	0.00 bar 149.9 °C	----- 4.02 + 4.03 = 149.9 °C	----- 5.02 = 149.9 °C	-----	
Controller Setup										
PIN Protection	OFF	OFF	OFF	OFF	OFF	OFF	OFF	OFF	OFF	
Set protection	OFF	OFF	OFF	OFF	OFF	OFF	OFF	OFF	OFF	
Save User Setup	OFF	OFF	OFF	OFF	OFF	OFF	OFF	OFF	OFF	
Alarm sensors		ON	ON	ON	ON	ON	ON	ON	ON	
Limit	-----	-----	-----	-----	-----	-----	-----	-----	-----	
Min. speed cut off		OFF	OFF	OFF	OFF	OFF	OFF	OFF	OFF	
1. Min. speed cut off ²										
2. Min. speed cut off ³										
Val>Set=n+		ON	ON	ON	ON	ON	OFF	OFF	OFF	
1. Val>Set=n ²										
2. Val>Set=n ³										
Type of control		P	P	P	P	P	Pid	Pid	Pid	
1. Controller type ²										
2. Controller type ³										
KP		50 %	50 %	50 %	50 %	50 %	50 %	50 %	50 %	
KI		50 %	50 %	50 %	50 %	50 %	50 %	50 %	50 %	
KD		50 %	50 %	50 %	50 %	50 %	50 %	50 %	50 %	
TI		0 %	0 %	0 %	0 %	0 %	0 %	0 %	0 %	
Group version	0	0	0	0	0	0	0	0	0	
Group 2 ON value	-----	-----	-----	-----	-----	-----	-----	-----	-----	
OFF Value Group2	-----	-----	-----	-----	-----	-----	-----	-----	-----	
nmin at Group2	-----	-----	-----	-----	-----	-----	-----	-----	-----	
Group 3 ON value	-----	-----	-----	-----	-----	-----	-----	-----	-----	
OFF Value Group3	-----	-----	-----	-----	-----	-----	-----	-----	-----	
nmin at Group3	-----	-----	-----	-----	-----	-----	-----	-----	-----	
Group 4 ON value	-----	-----	-----	-----	-----	-----	-----	-----	-----	
OFF Value Group4	-----	-----	-----	-----	-----	-----	-----	-----	-----	
nmin at Group4	-----	-----	-----	-----	-----	-----	-----	-----	-----	
External message	External error									
Offset control sig. 1	0 %	0 %	0 %	0 %	0 %	0 %	0 %	0 %	0 %	
Selection amplifier		OFF	OFF	OFF	OFF	OFF	OFF	OFF	OFF	
IO Setup										
A1 Function	2A	2A	2A	2A	2A	2A	2A	2A	2A	
A1 min.	0.0 V	0.0 V	0.0 V	0.0 V	0.0 V	0.0 V	0.0 V	0.0 V	0.0 V	
A1 max.	10.0 V	10.0 V	10.0 V	10.0 V	10.0 V	10.0 V	10.0 V	10.0 V	10.0 V	
A1 Inverting	OFF	OFF	OFF	OFF	OFF	OFF	OFF	OFF	OFF	
A2 Function	1A	1A (2.03 = 6A)	1A	1A	1A	1A	1A	1A	1A	
A2 min.	0.0 V	0.0 V	0.0 V	0.0 V	0.0 V	0.0 V	0.0 V	0.0 V	0.0 V	
A2 max.	10.0 V	10.0 V	10.0 V	10.0 V	10.0 V	10.0 V	10.0 V	10.0 V	10.0 V	

Mode	1.01	2.01	2.02	2.05	3.01	3.03	4.01	5.01	6.01	User Setting
	1.02	2.03			3.02	3.04	4.02	5.02		
Parameter	Factory setting									
A2 Inverting	OFF	OFF	OFF	OFF	OFF	OFF	OFF	OFF	OFF	OFF
D1 Function	OFF	OFF	OFF	OFF	OFF	OFF	OFF 4.03 = 1D	OFF	OFF	OFF
D1 Inverting	-----	-----	-----	-----	-----	-----	----- 4.03 = OFF	-----	-----	-----
D1 Busmode	-----	-----	-----	-----	-----	-----	----- 4.03 = ON	-----	-----	-----
D2 Function	OFF	OFF	OFF	OFF	OFF	OFF	OFF 4.03 = 5D	OFF	OFF	OFF
D2 Inverting	-----	-----	-----	-----	-----	-----	----- 4.03 = OFF	-----	-----	-----
D2 Busmode	-----	-----	-----	-----	-----	-----	----- 4.03 = ON	-----	-----	-----
D - D Relation	OG	OG	OG	OG	OG	OG	OG	OG	OG	OG
E1 Inverting	OFF	OFF	OFF	OFF	OFF	OFF	OFF	OFF	OFF	OFF
E1 Busmode	OFF	OFF	OFF	OFF	OFF	OFF	OFF	OFF	OFF	OFF
E2 Inverting	-----	----- 2.04 = OFF	-----	OFF	-----	OFF	----- 4.02 + 4.03 = OFF	----- 5.02 = OFF	OFF	OFF
E2 Busmode	OFF	OFF	OFF	OFF	OFF	OFF	OFF 4.03 = ON	OFF	OFF	OFF
K1 Function	1K	1K (2.03 = 2K)	1K	1K	1K	1K	1K	1K	1K	1K
K1 Inverting	OFF	OFF	OFF	OFF	OFF	OFF	OFF	OFF	OFF	OFF
K2 Function	2K	2K (2.03 = 9K)	2K	2K	2K	2K	2K	2K	2K	2K
K2 Inverting	OFF	OFF	OFF	OFF	OFF	OFF	OFF	OFF	OFF	OFF
COM2 Function	MODBUS Slave									
Limits										
Level Function 1. Level. Function ²	OFF	OFF	OFF	OFF	OFF	OFF	OFF	OFF	OFF	OFF
Level min. 1. Level min. ²	-----	-----	-----	-----	-----	-----	-----	-----	-----	-----
Level max. 1. Level max. ²	-----	-----	-----	-----	-----	-----	-----	-----	-----	-----
Level Delay 1. Level Delay ²	-----	-----	-----	-----	-----	-----	-----	-----	-----	-----
Lmt E1 Function	OFF	OFF 2.03 = 1L	OFF	OFF	OFF	OFF	OFF	OFF	OFF	OFF
Lmt E1 min	-----	----- 2.03 = 0.0 °C	-----	-----	-----	-----	-----	-----	-----	-----

Mode	1.01	2.01	2.02	2.05	3.01	3.03	4.01	5.01	6.01	User Setting
	1.02	2.03			3.02	3.04	4.02	5.02		
Parameter	Factory setting									
Lmt E1 max.	-----	----- 2.03 = 40.0 °C	-----	-----	-----	-----	-----	-----	-----	
Lmt E1 Hyst.	-----	----- 2.03 = 1.0 K	-----	-----	-----	-----	-----	-----	-----	
Lmt E1 Del.	-----	----- 2.03 = 2 sec.	-----	-----	-----	-----	-----	-----	-----	
Lmt E2 Function	-----	----- 2.04 = OFF	-----	OFF	-----	OFF	----- 4.02,03 = OFF	----- 5.02 = OFF	-----	
Lmt E2 min.	-----	-----	-----	-----	-----	-----	-----	-----	-----	
Lmt E2 max.	-----	-----	-----	-----	-----	-----	-----	-----	-----	
Lmt E2 Hyst.	-----	-----	-----	-----	-----	-----	-----	-----	-----	
Lmt E2 Del.	-----	-----	-----	-----	-----	-----	-----	-----	-----	
Offset Function 1. Offset Function ²		OFF	OFF	OFF	OFF	OFF	OFF	OFF	OFF	
Offset 1 1.Offset 1 ²		-----	-----	-----	-----	-----	-----	-----	-----	
Offset 2 1.Offset 2 ²		-----	-----	-----	-----	-----	-----	-----	-----	
Offset Hyst. 1. Offset Hyst. ²		-----	-----	-----	-----	-----	-----	-----	-----	
Offset Delay 1. Offset Del. ²		-----	-----	-----	-----	-----	-----	-----	-----	
Timer										
Time	14:24	14:24	14:24	14:24	14:24	14:24	14:24	14:24	14:24	
Date	19.04.13	19.04.13	19.04.13	19.04.13	19.04.13	19.04.13	19.04.13	19.04.13	19.04.13	
Summertime Auto.	OFF	OFF	OFF	OFF	OFF	OFF	OFF	OFF	OFF	
Timer Function	OFF	OFF	OFF	OFF	OFF	OFF	OFF	OFF	OFF	
Mon										
Mon ON1	--:--	--:--	--:--	--:--	--:--	--:--	--:--	--:--	--:--	
Mon OFF1	--:--	--:--	--:--	--:--	--:--	--:--	--:--	--:--	--:--	
Mon ON2	--:--	--:--	--:--	--:--	--:--	--:--	--:--	--:--	--:--	
Mon OFF2	--:--	--:--	--:--	--:--	--:--	--:--	--:--	--:--	--:--	
RTC Adjust	60	60	60	60	60	60	60	60	60	
Timer Inverting	OFF	OFF	OFF	OFF	OFF	OFF	OFF	OFF	OFF	
Override Time	120 min	120 min	120 min	120 min	120 min	120 min	120 min	120 min	120 min	
Override Status	OFF	OFF	OFF	OFF	OFF	OFF	OFF	OFF	OFF	
Diagnostic										
Runtime Controller	000056:- 46:13	000056:- 46:13	000056:- 46:13	000056:- 46:13	000056:- 46:13	000056:- 46:13	000056:- 46:13	000056:- 46:13	000056:- 46:13	
Runtime Motor	000056:- 46:13	000056:- 46:13	000056:- 46:13	000056:- 46:13	000056:- 46:13	000056:- 46:13	000056:- 46:13	000056:- 46:13	000056:- 46:13	
E1 - KTY	20.0 °C	20.0 °C	20.0 °C	20.0 °C	20.0 °C	20.0 °C	20.0 °C	20.0 °C	20.0 °C	
E1-Current	0.00 mA	0.00 mA	0.00 mA	0.00 mA	0.00 mA	0.00 mA	0.00 mA	0.00 mA	0.00 mA	
E1 - Voltage	0.00 V	0.00 V	0.00 V	0.00 V	0.00 V	0.00 V	0.00 V	0.00 V	0.00 V	
E2 - KTY	20.0 °C	20.0 °C	20.0 °C	20.0 °C	20.0 °C	20.0 °C	20.0 °C	20.0 °C	20.0 °C	
E2-Current	0.00 mA	0.00 mA	0.00 mA	0.00 mA	0.00 mA	0.00 mA	0.00 mA	0.00 mA	0.00 mA	

Mode	1.01	2.01	2.02	2.05	3.01	3.03	4.01	5.01	6.01	User Setting
	1.02	2.03			3.02	3.04	4.02	5.02		
Parameter	Factory setting									
E2 - Voltage	0.00 V	0.00 V	0.00 V	0.00 V	0.00 V	0.00 V	0.00 V	0.00 V	0.00 V	0.00 V
D1	OFF	OFF	OFF	OFF	OFF	OFF	OFF	OFF	OFF	OFF
D2	OFF	OFF	OFF	OFF	OFF	OFF	OFF	OFF	OFF	OFF
K1	OFF	OFF	OFF	OFF	OFF	OFF	OFF	OFF	OFF	OFF
K2	ON	ON	ON	ON	ON	ON	ON	ON	ON	ON
MODBUS Slave										
Bus Address	247	247	247	247	247	247	247	247	247	247
Addressing	OFF	OFF	OFF	OFF	OFF	OFF	OFF	OFF	OFF	OFF
UART Baudrate	19200	19200	19200	19200	19200	19200	19200	19200	19200	19200
UART Mode	8E1	8E1	8E1	8E1	8E1	8E1	8E1	8E1	8E1	8E1
MODBUS Master										
Autoaddressing										
Bus Slavecount	0	0	0	0	0	0	0	0	0	0

- 1 For adjustment "Setting Sep" > 0 (☞ Base setup)
- 2 For control circuit 1 in operation with a second control circuit (☞ Base Setup / Function E2)
- 3 For control circuit 2 in operation with a second control circuit (presetting depending on programmed function)
- 4 In operation with control circuit 2 and programmed function 15 D for digital input (☞ IO Setup)
- 5 In operation with control circuit 2 and programmed function 16 D for digital input (☞ IO Setup)

10.2 Possible allocation of the IOs, PINs

Units for analog inputs E1 and E2

The following units can be set for programmed sensors with free measuring range (0 - 10 V, 0 - 20 mA, 4 - 20 mA).	
E1 Analog In *	°C, m ³ /h, bar, %, Pa, m/s, m ³ /s, Ohm, mbr, °F, ft/s, cfm, in.wg, psi, ppm
E2 Analog In	

* for Modes **5.01** and **5.02** display in m³/h, other units are not possible

Analog outputs A1 and A2

Function	Description
OFF	no function
Constant voltage 10 V (1A)	Constant voltage +10 V Factory setting for "A2" at operation with one control circuit.
1st control signal (2A)	Controlled 0 - 10 V output for control circuit 1 (factory setting for "A1")
E1 (3A)	proportional input "E1"
E2 (4A)	proportional input "E2"
Group2 (5A)	Group control (☞ Controller Setup - group 2)
2.Cooling (6A)	Only for mode 2.03 temperature controller with additional functions. Controller output 2 with rising activation at Actual>Nominal = Cool .
2.Heating (7A)	Only for mode 2.03 temperature controller with additional functions. Controller output 2 with rising activation at Actual<Nominal = Heat .
2. control signal (8A)	Controlled 0 - 10 V output vor control circuit 2. Factory setting for "A2" at operation with second control circuit. A second control circuit can be activated if required by programming the E2 function (☞ Base Setup E2 functions 8E - 13E and second control circuit)
Speed (9A)	proportionally 1.Control signal
Group3 (11A)	Group control (☞ Controller Setup - group 3)
Group4 (12A)	Group control (☞ Controller Setup - group 4)
Offset control sig. 1 (14A)	Offset control signal 1 Setting offset ☞ Controller Setup

Digital inputs D1 and D2

Function	Description
OFF	No function (factory setting)
Enable (1D)	Enable (remote control) "ON" / "OFF"
External error (2D)	External fault alarm
Limit (3D)	"Limit" ON / OFF Influences control circuit 1 and control circuit 2
E1 / E2 (4D)	Switch over input "E1" / "E2" (for operation with one control circuit)
Reset (10D)	Complete re-start of the device
Max. Speed (11D)	Setting Max. Speed "ON" / "OFF" Influences the respectively set value "1. Max. Speed" and "2. Max. Speed" in operation with two control circuits.
Override Time (21D)	Overwrite timer function (in operation with timer)
For Mode Speed controller 1.01	
Setpoint1/2 (5D)	Switch over "Set Intern1" / "Set Intern2" "Setting External 1" must be at "OFF".
Setpoint int./ext. (6D)	Switch over "Intern" / "Extern"
For modes as controller higher 2.01	
Setpoint1/2 (5D)	Switch over "Setpoint 1" / "Setpoint 2" for control circuit1
Setpoint int./ext. (6D)	Switch over "Intern" / "Extern" Possible only for operation with one control circuit!
Control/Manual (7D)	Switch over "automatic control" / "Speed manual" Possible only for operation with one control circuit!
Heating/Cooling (8D)	Switch over control function (e.g. "heating" / "cooling")
1.Setp+Pband1/2 (15D)	for control circuit 1: Switch over Setpoint 1/2 and Pband 1/1 When programming this function, "Setting" additionally lists the parameter: "1.Pband2 for control circuit 1."
Only active in operation with a second control circuit!	
E1 / E2 (4D)	The output for control circuit 2 is set additionally to "A2" to "A1" (regardless of the programmed function for <u>A1</u>). The first control circuit has no output for the duration of the switch over. The switch over input "E1" / "E2" as in operation with one control circuit is no longer possible.
2. Setpoint 1/2 (9D)	for control circuit 2: Switch over "Setpoint 1" / "Setpoint 2"
2.Setp+Pband1/2 (16D)	for control circuit 2: Switch over Setpoint 1/2 and Pband 1/2 When programming this function, "Setting" additionally lists the parameter: "2Pband2 for control circuit 2."

Analogue input E2

Function	Description Function E2
OFF	No function (factory setting)
For mode speed controller 1.01	
1E	Operation with a second setting signal (switch over "E1" <-> "E2" via floating contact)
4E	Operation with a second setting signal and automatic control at the higher level ("E1" <-> "E2")
For modes as controller higher 2.01	
Ext. Setpoint (1E)	1E = External Setpoint e.g. via external signal (0 - 10 V) instead of "Setpoint 1"
Ext. Manual mode (2E)	External manual operation via external signal (0 - 10 V). Switch over between settings on the device and external manual operation via digital input.
Average E1 (3E)	Sensor average with E1 (☞ mode 2.04)
Comparison E1 (4E)	Sensor comparison with E1 (☞ mode 2.04)
Difference E1 (5E)	Sensor difference to E1 (☞ mode 2.05)
Setpoint derating (6E)	Sensor for setpoint outdoor temperature controlled (☞ mode 4.02, 5.02).
Measurement (7E)	Measurement value e.g. Measurement value e.g. for limit indication, display in Info menu "E2 Actual".
For activation of a second control circuit (only possible in certain modes (☞ operation with second control circuit))	
Temperature (8E)	Temperature control, pre-settings and sensor selection correspond to mode 2.01
Cold-Pressure (9E)	Pressure control condensers, pre-settings and sensor selection correspond to mode 3.01
Cold-Temperature (10E)	Pressure control condensers with input for refrigerant, pre-settings, sensor selection and input for refrigerant corresponding to mode 3.02
Air Pressure (11E)	Pressure control air conditioning, pre-settings and sensor selection correspond to mode 4.01
Air flow (12E)	Volume control, pre-settings, sensor selection and K-factor for inlet ring correspond to mode 5.01
Air speed (13E)	Air velocity control, pre-settings correspond to mode 6.01

Digital outputs K1 and K2

Function	Description
OFF	No function Relays remain always de-energized
Operating indication (1K)	Operating indication (factory setting for "K1", non inverting). Operation without fault, reports enable "OFF"
Fault indication (2K)	Fault indication (factory setting for "K2", non inverting). Pulled up in operation without fault, with release "OFF" not dropped out. Drops out in case of line and device fault and external fault at the digital input. Depending on programming in event of sensor failure.
External error (3K)	External fault separate with message at digital input (factory setting if terminals bridged)
Limit modulation (4K)	Limit modulation Over or falling below limits for modulation
Limit E1 (5K)	Limit "E1" When over or falling below limits for input signal "E1"
Limit E2 (6K)	Limit "E2" When over or falling below limits for input signal "E2"
For modes as controller higher 2.01	
Setpoint Offset (7K)	Setpoint Offset Deviation between actual value and setpoint to high
Group2 (8K)	Group control (Group 2) Switching on fans depending on modulation
Group3 (12K)	Group control (Group 3) Switching on fans depending on modulation
Group4 (14K)	Group control (Group 4) Switching on fans depending on modulation
For modes as temperature controller with additional functions 2.03	
2.Heating (9K)	Heating function Switch ON point: temperature = Setpoint +/- Offset Switch OFF point: Temperature around hysteresis over switch ON point
2.Cooling (10K)	Cooling function Switch ON point: temperature = Setpoint +/- Offset Switch OFF point: Temperature around hysteresis below switch ON point

Limits GW E1 and GW E2

Function	Description function GW E1, GW E2
OFF	no function
Failure (1L)	Indication with the centralized fault of a programmed relay (IO allocation Function 2K). Warning symbol in display, "AL" code in events memory.
Message (2L)	Is merely displayed in the events menu as message "msg".
Filter error (3L)	Like function 1L with fault message "Filter"
Filter Message (4L)	Like function 2L with fault message "Filter"

PINs

PIN	Function
PIN 0010	Opening service menu, if PIN-protection activated
PIN 1234	Opening "setting". if "set protection" = "ON" (☞ Controller Setup)
PIN 9090	Restore user setting
PIN 9091	Save user setting (corresponds function "Save user setup" = "ON"☞ Controller Setup)
PIN 9095	Restore factory setting = delivery status

11 Diagnostics menu

Main menu	The diagnostics menu supplies information about the momentary operating condition of the device.
IO Setup	
Limits	
Timer	
Autoaddressing	
Diagnostic	
Diagnostic	Operating hours on the line
000419:27:28 Runtime Controller	The time counter (h:m:s) runs as soon as line voltage is applied to the device and the device is switched on (without failure). If events occur (e.g. sensor failure, MODBUS communication etc.), the operating time at this time is also saved (☞ Protocol).
Diagnostic	Operating hours with modulation
000146:23:54 Runtime Motor	The time counting (h:m:s) runs only when a modulation of the controller is present
Diagnostic	Signal height at analog input E1 (Analog In 1)
20.0 °C E1 - KTY	
Diagnostic	
9.0 mA E1-Current	
Diagnostic	
4.0 V E1 - Voltage	
Diagnostic	Signal height at analog input E2 (Analog In 2)
20.0 °C E2 - KTY	
Diagnostic	
9.0 mA E2-Current	

Diagnostic	
4.0 V E2 - Voltage	
Diagnostic	Status digital input 1 (Digital In 1)
OFF D1	ON = terminals D1 - 24V bridged ↔ OFF = terminals D1 - 24V not bridged
Diagnostic	Status digital input 2 (Digital In 2)
OFF D2	ON = terminals D2 - 24V bridged ↔ OFF = terminals D2 - 24V not bridged
Diagnostic	OFF = relay K1 de-energized: terminals 11 - 12 bridged
ON K1	ON = relay K1 energized: terminals 11 - 14 bridged
Diagnostic	OFF = relay K2 de-energized: terminals 21 - 22 bridged
OFF K2	ON = relay K2 energized: terminals 21 - 24 bridged



12 Protocol

12.1 Display and query of events and malfunctions

Main menu	Events during operation can lead to a malfunctioning of the device.
Start	The last 100 events are saved in the "Protocol" menu group.
Setting	Position 1 = latest event, display: Protocol 1/100
Protocol	Position 100 = last saved event, display: Protocol 100/100
Base setup	
Controller Setup	The saved events are retained even after resetting to factory setting (☞ menu group Start / PIN input)!

The device distinguishes between several event types which are identified by different symbols.

Example

Protocol 1/100		Attention symbol = message
Modulation Runtime Controller 000493:04:59		The message is only listed in the protocol. There is no message alternately with the actual value display and no message via alarm relay. Exception In case of sensor failure there is always a message in the display (☞ Controller Setup / Alarm Sensors) .
Protocol 2/100		Bell symbol = Alarm
Error MODBUS Com Runtime Controller 000193:04:59		The alarm message is listed in the protocol and appears alternately with the actual value display. Message by alarm relay depending on the type of failure and programming.
Protocol 2/100		Cross symbol = previous messages
Line Fault Runtime Controller 000493:04:59		Cause of the message no longer exists.

Example: Previous line failure on a member

Protocol 2/100		
Line Fault Runtime Controller 000493:04:59		Previous line failure on a member connected via the MODBUS interface. When the failure was cleared (line voltage available again), the device was on the line for 493 hours, 4 minutes and 59 seconds.
[P] Details	[ESC]Menu	

Press the P-key to show further details.

Protocol 2/100		
Line Fault		Date and time when the failure was cleared (time setting ☞ timer)
Date 15.04.13	Time 10:24	
[P] Details	[ESC]Menu	

Press the P-key to show further details.

Protocol 2/100		
Line Fault Place Fan 1		Member on which the failure occurred.
[P] Details	[ESC]Menu	





Press the P-key to show further details.









Protocol 2/100		
Line Fault Modulation 0 %		Modulation of the member at the time of the message.
[P] Details	[ESC]Menu	



Exit the menu with the Esc key combination ▼ + ▲ .

12.2 Messages and trouble shooting

A momentary pending alarm or error message is indicated by a blinking display and appears alternately with the actual value display.

Display	Relais switches *		Cause	Reaction of Controller
	Opera- tion	Failure		Adjustment
no display	-	-	No line voltage Jumper J1 for USB interface plugged	Line voltage available? Unit switch OFF and automatically ON when the voltage has been re-stored Check line fuse Check jumper J1, pull off or only plug to one PIN
OFF	X	-	No enable	Switch OFF by external contact (function 1D) = enable programmed for Digital In)
 Factory setting	-	-	fault in Eprom	Works with defaults.
 EEP error	-	X	fault EEP damaged	Works with defaults.
 EEP Corruption	X	X	EEP data incorrectly	controller runs with the read settings.
 Sensor 1	-	X	Sensor 1 Interruption / short circuit in the sensor leads or sensor values measured are outside measuring range	The device works with minimal or maximum modulation depending on whether there is a short-circuit or an interruption, and on the programmed mode of operation. Check sensor
 Sensor2	-	X	Sensor2 Interruption / short circuit in the sensor leads or sensor values measured are outside measuring range	The device works with minimal or maximum modulation depending on whether there is a short-circuit or an interruption, and on the programmed mode of operation. Check sensor

Display	Relais switches *		Cause	Reaction of Controller
	Operation	Failure		Adjustment
 <p>External error * EC Motors Filter Frost protection Adiabatic Firealarm Pressure switch Gas alarm Water alarm RCD</p>	-	X	Alarm from external contact	Device continues working unchanged. check contacts.
Messages for programmed limits				
 <p>Modulation Filter **</p>	-	X	Limit alarm modulation	Device continues working unchanged. ☞ Limit indication depending on modulation. .
 <p>Lmt E1 min Filter **</p>	-	X	Limit indication minimum Signal actual value at "E1" below setting	Device continues working unchanged. ☞ Limit indication depending on setting or sensor signal.
 <p>Lmt E1 max. Filter **</p>	-	X	Limit indication maximum Signal actual value at "E1" above setting	Device continues working unchanged. ☞ Limit indication depending on setting or sensor signal.
 <p>Lmt E2 min. Filter **</p>	-	X	Limit indication minimum Signal actual value at "E2" above setting	Device continues working unchanged. ☞ Limit indication depending on setting or sensor signal.
 <p>Lmt E2 max. Filter **</p>	-	X	Limit indication maximum Signal actual value above setting	Device continues working unchanged. ☞ Limit indication depending on setting or sensor signal.
 <p>Offset 1 Filter **</p>	-	X	Limit alarm deviation from Offset 1 too high	Device continues working unchanged. ☞ Limits depending on the deviation from the setpoint.
 <p>Offset 2 Filter **</p>	-	X	Limit alarm deviation from Offset 2 too high	Device continues working unchanged. ☞ Limits depending on the deviation from the setpoint.
For operation as MODBUS Master				
When networking via the MODBUS Master interface, the individual error messages of the members are displayed. These depend on the type of member (☞ operating instructions of the respective device). Example:				
 <p>Error MODBUS Com Fan: 8</p>	-	X	Connection to the MODBUS Master interface interrupted Entered member count too high	Device continues working unchanged. Check member count Check MODBUS connection.

Display	Relais switches *		Cause	Reaction of Controller
	Operation	Failure		Adjustment
 Motor fault Fan: 3	-	X	Example for motor fault at member with address 3	The control module continues running unchanged. Reset required on the member (☞ operating instructions of the device concerned).
 Line Fault Fan: 6	-	X	Example for line failure at member with address 6	The control module continues running unchanged. Check line supply of member.

* Alternative display texts for error message via external contact ☞ Controller Setup / display text for external message.

** Alternative display texts for limit alarms ☞ limits function [3L]

13 Enclosure

13.1 Technical data

Type	CXE/AVC MODBUS
Part-No.	37256 (320053-42)
Line voltage	1 ~ 230 V (-15 % bis +10 %), 50/60 Hz
Weight	0,9 kg
Input resistance for sensor or signal set for the rotational speed (E1, E2)	for 0 - 10 V input: $R_i > 900 \text{ k}\Omega$ for input 4 - 20 mA: $R_i = 250 \text{ }\Omega$ (max. load 500 Ω)
Voltage supply e.g. for sensors	+24 V (-30...+20 %), $I_{\text{max}} 70 \text{ mA}$
Analog output (A1, A2 0 - 10 V)	Load resistance (load) $> 5 \text{ k}\Omega$ Short-circuit proof, short-circuit current = 24 mA
Digital inputs (D1, D2)	R_i approx. 7.8 k Ω Input current typ. 2.5 mA Voltage range high level: 7.1...19 V DC Voltage range low level: 0....2.7 V DC
Max. heat dissipation	approx. 10 W
Max. line fuse	10 A
Max. permissible ambient temperature	55 °C
Min. permissible ambient temperature	0 °C (if mains voltage is not switched off up to -20 °C)
Permissible rel. humidity	85 % no condensation
Electromagnetic compatibility for the standard voltage 230 / 400 V according to DIN IEC 60038	Interference emission EN 61000-6-3 (domestic household applications)
	Interference immunity EN 61000-6-2 (industrial applications)
Housing protection	IP54

Connectable conductors (information for all terminals)

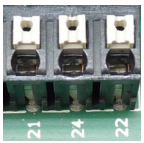
		Cross section min.	Cross section max.
Push-In Terminals 	Terminal range, rated connection	0.13 mm ²	1.5 mm ²
	Wire connection cross section AWG	AWG 24	AWG 16
	Solid H05(07) V-U	0.2 mm ²	1.5 mm ²
	Flexible H05(07) V-K	0.2 mm ²	1.5 mm ²
	With wire end ferrule DIN 46 228/1	0.25 mm ²	1.5 mm ²
	Wire plastic collar ferrule DIN 46 228/4,	0.25 mm ²	0.75 mm ²
	Rigid conductors and conductors with wire end ferrules can be plugged into the terminal without tools. Use the flexible conductor for connection and the push button for release. Stripping length: 8 mm		
The data refer to the connection possibilities of the terminals. The necessary conductor cross section must be dimensioned according to the respective prevailing conditions.			

13.2 Connection diagram

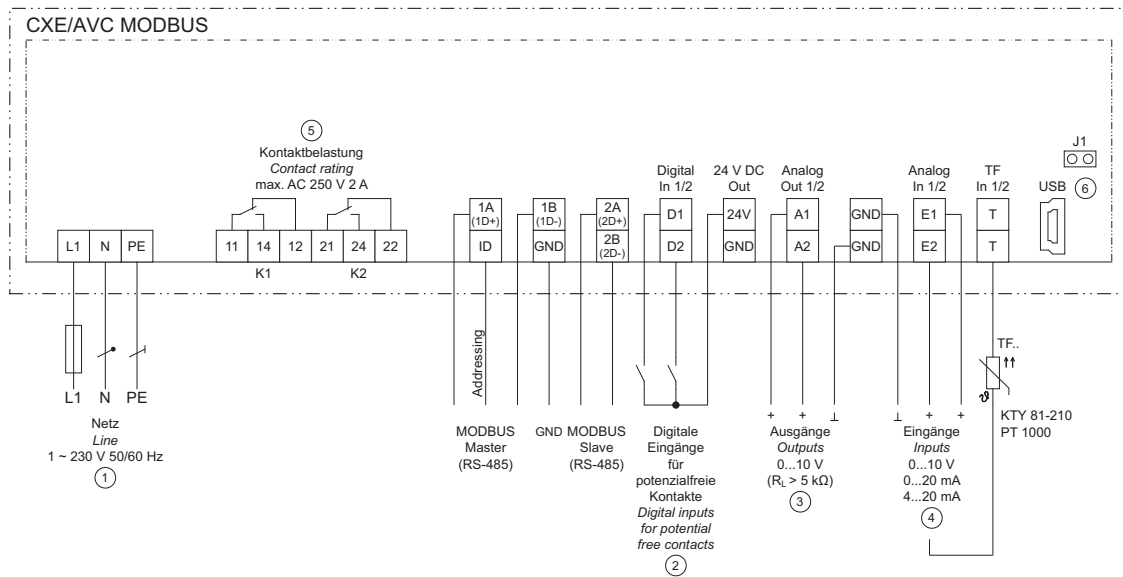

MCRE17K3
26.08.2014

- 1 Line
- 2 Digitale Eingänge für potenzialfreie Kontakte
Digital inputs for potential free contacts
- 3 Ausgänge Outputs 0...10 V, 0...20 mA, 4...20 mA, TF.. (KTY, Pt1000)
Outputs ($I_{max} = 2 \text{ mA}$): A1 pre-programmed control output e.g. for controlling a speed controller. Fans with integrated controller and input 0 - 10 V can be activated directly. A2 pre-programmed for constant voltage +10 V
- 4 Eingänge Inputs 0...10 V, 0...20 mA, 4...20 mA
- 5 Kontaktbelastung Contact rating max. AC 250 V 2 A (ohmic load)
- 6 Jumper J1 for USB interface (Bootloader)

Attention!

Plug the jumper J1 to both PINs only for a software update via USB interface. The device will not switch on if this jumper is plugged to both PINs!
Do not replug the jumper under voltage, observe the safety instructions!

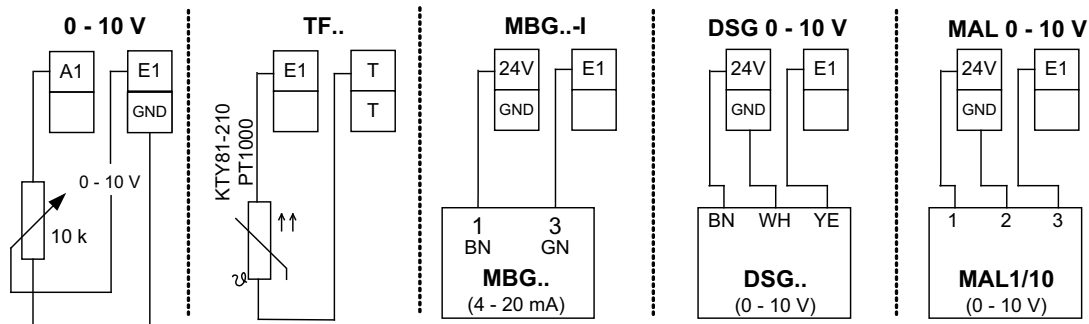

19.09.2012
v_sensoren_e1_t1_anschplan.vsd

13.3 Dimensions [mm]

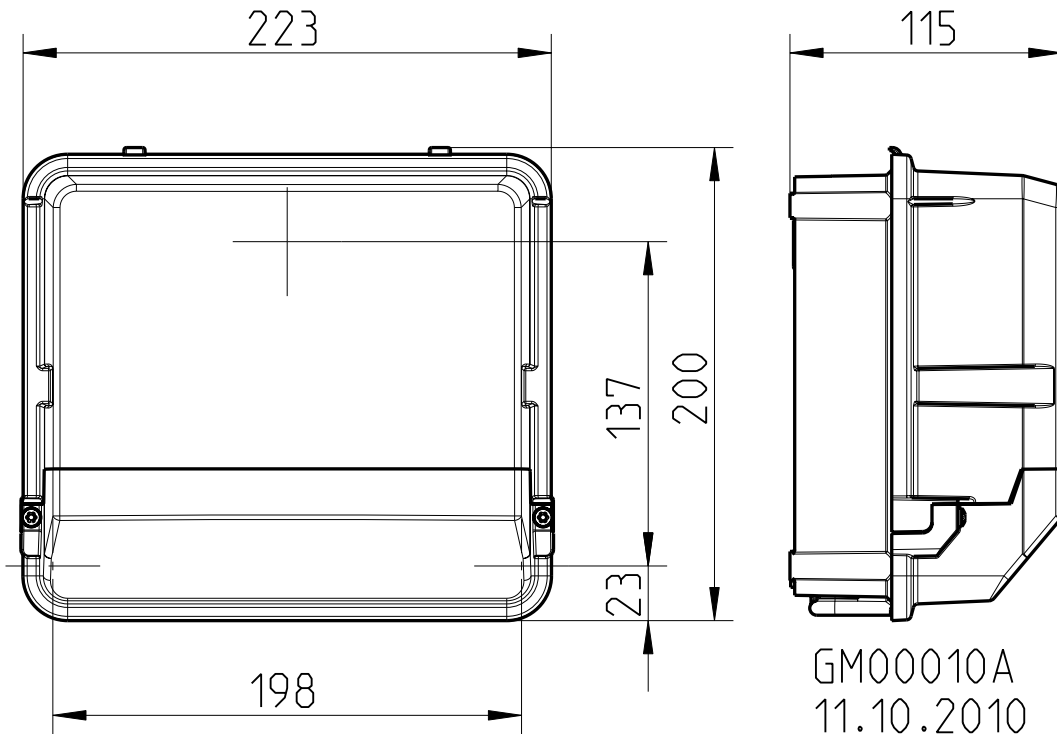

13.4 Index

A		Mode	16
addition,	12	O	
addressed	13	Outdoor installation	9
automatic addressing	13, 88	P	
Average calculation	31	P-component	55
B		pin code	49
Base setup	54	PIN input	49
bus mode	74	PIN protection	51-52
C		Protocol	104
COM2	76	PT1000	11, 30
control cable	10	R	
control circuit 1	17	refrigerant	38
Control circuit 2	17	Relay outputs	12
D		S	
D-component	55	second control circuit	18
date	81	SIM	76
diagnostics menu	102	SMS	76
Digital inputs	63	standard voltages	10
DSG	41, 44	State menu	90
E		summertime automatic	83
Enable	65	switching times	84
error message	105	T	
Events	104	Technical data	4, 108
External Setpoint	20	time	81
G		timer function	81
group control	56	two-wire-technology	11
I		U	
I-component	55	USB	15
Input resistance	108	user settings	52
K		W	
K Factor	44	wintertime	83
L			
Limit	53		
Limits	77		
M			
mains is connected	10		
mains voltage	10		
MAL	47		
MBG	37		
member count	89		
members	87, 90		
Menu tables	91		
Minimum speed cut off	53		
MODBUS Master	12, 87		
MODBUS Slave	12, 86		

13.5 Manufacturer reference

Our products are manufactured in accordance with the relevant international regulations. If you have any questions concerning the use of our products or plan special uses, please contact:

Systemair
Industrievägen 3
73930 Skinnskatteberg
Telefon:+46 (0) 222 440 00
Telefax:+46 (0) 222 440 99
mailbox@systemair.se
www.systemair.se