

# Cyklon H



colour included  
in the price



**Cyklon H** 410↑ × 1600↔ O1  
colour: RAL 1015

Integrated thermostatic valve, angled, left, chrome  
SLIM thermostatic head, chrome  
Integrated pipe-masking set, chrome

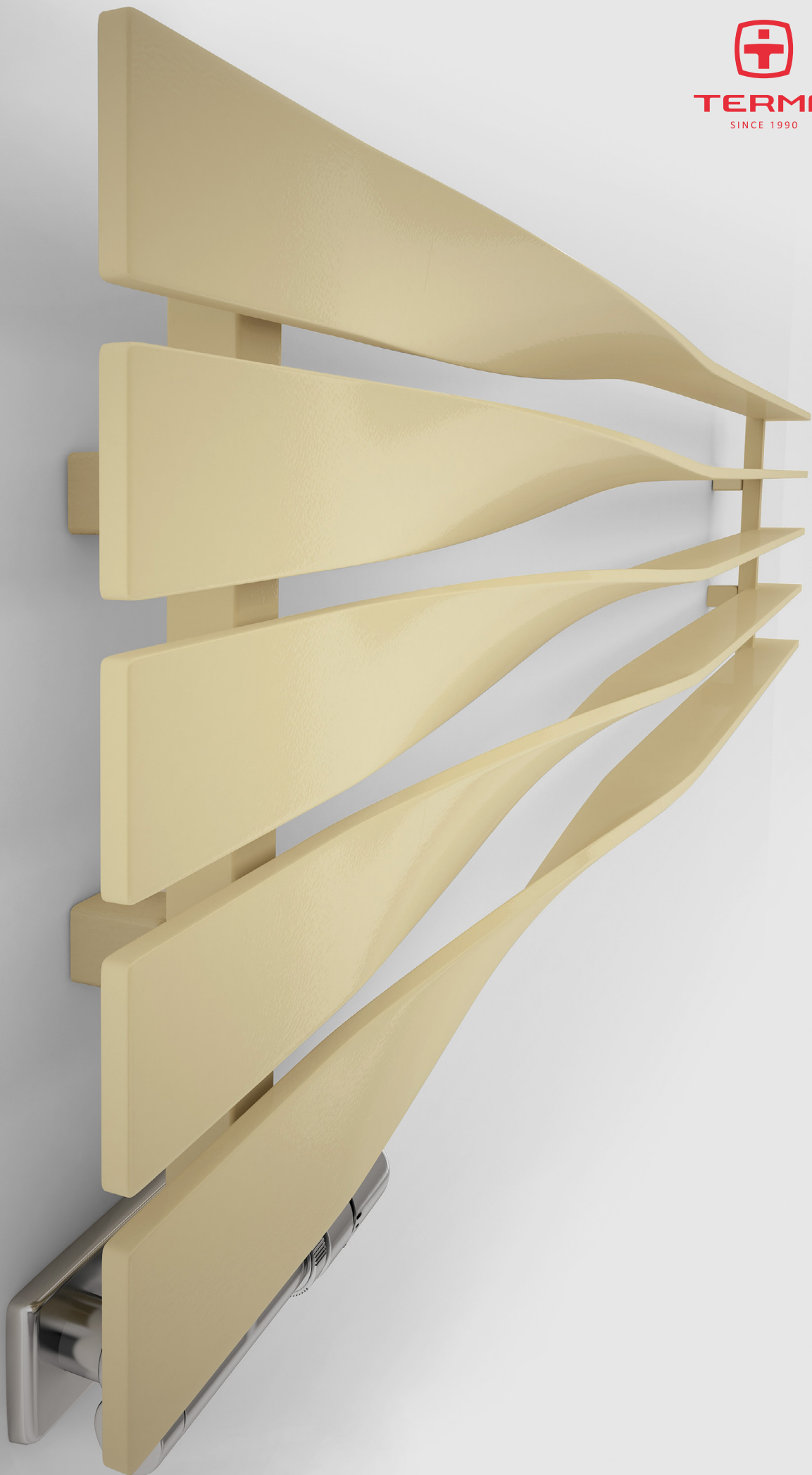



colour included  
in the price

Projekt : *Terma*

## Standard connection:

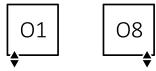

## Available sizes:

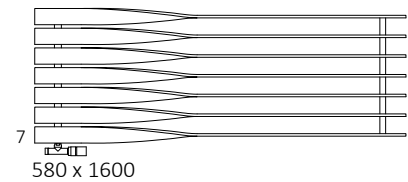
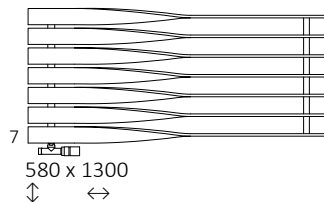
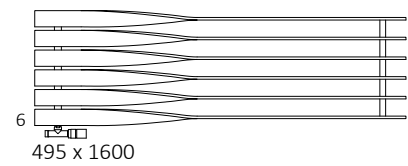
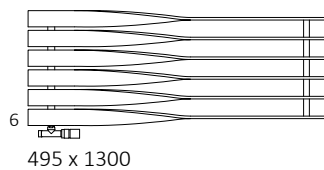
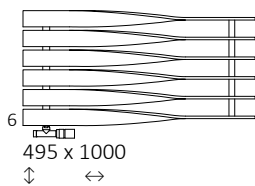
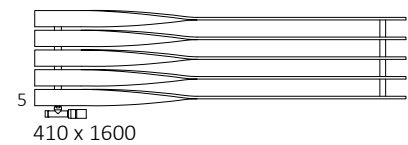
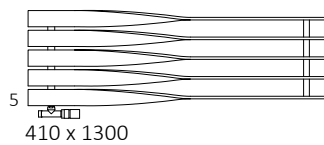
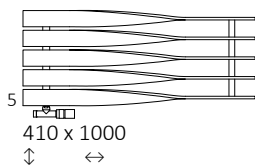

## Specification:

Working pressure: 700 kPa    Maximum operating temperature: 95°C

A ↕ [mm]	B ↔ [mm]	C1 [mm]	75/65/20°C [W]	55/45/20°C [W]	D [mm]	E [mm]	F [mm]	H [dm³]	⚖️ [kg]	Product code <small>Configuration code p. 5</small>
410	1000	50	408	212	800	170	120	2,59	13,40	WGCYH041100
410	1300	50	497	255	1100	170	120	3,29	17,09	WGCYH041130
410	1600	50	587	298	1400	170	120	3,98	20,78	WGCYH041160
495	1000	50	490	249	800	255	120	3,12	16,10	WGCYH049100
495	1300	50	597	299	1100	255	120	3,95	20,53	WGCYH049130
495	1600	50	704	349	1400	255	120	4,78	24,96	WGCYH049160
580	1300	50	697	342	1100	340	120	4,62	23,97	WGCYH058130
580	1600	50	821	399	1400	340	120	5,59	29,13	WGCYH058160



colour included  
in the price

## Technical drawing:

**01**

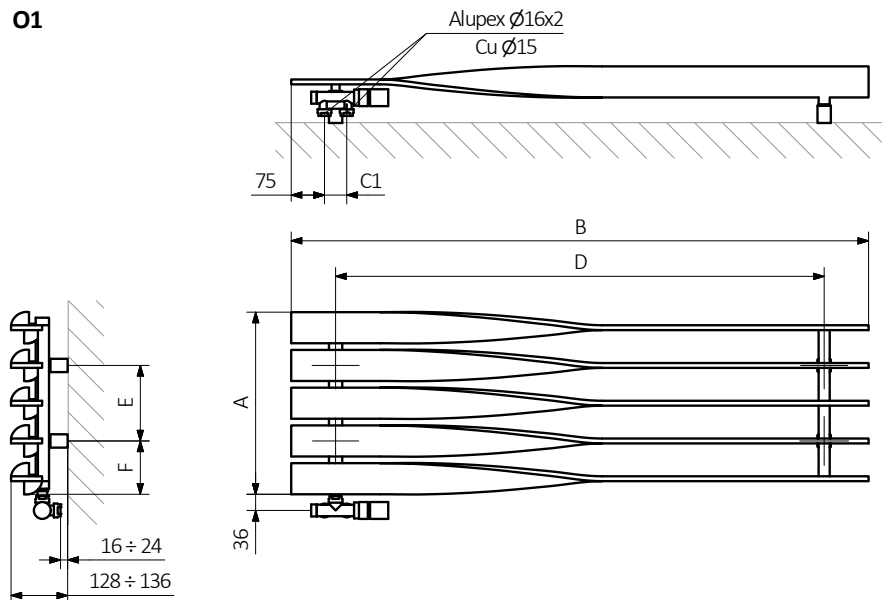

**08**

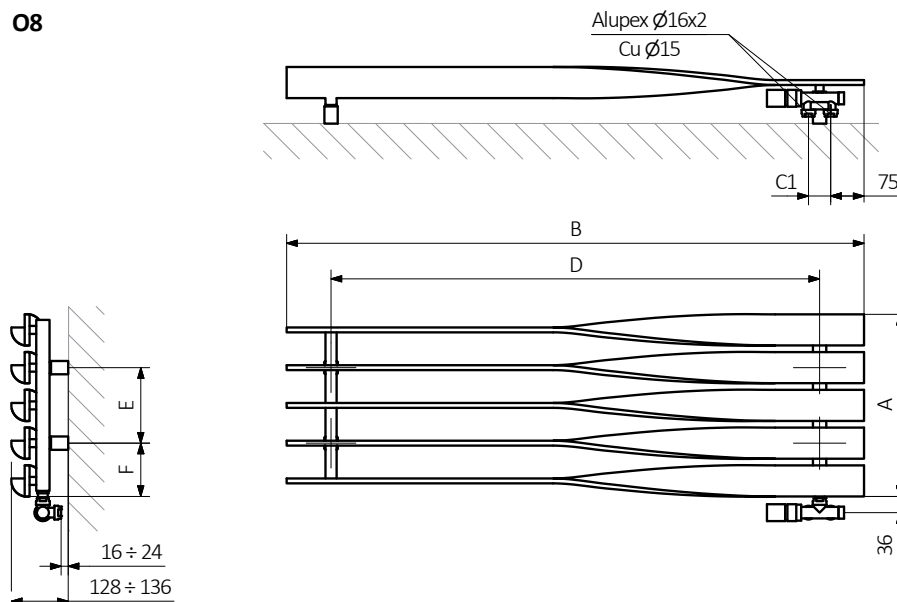

A – Height B – Width C1-C5 – Distance between pipe centres D – Horizontal distance between mounting bracket centres  
E – Vertical distance between mounting brackets F – Distance between a mounting bracket and the bottom of the radiator

**Collector :**

**Pipe :**

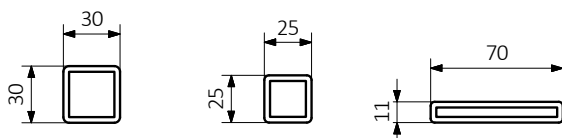



colour included  
in the price

In the table with technical data, the last column lists product codes. When placing an order, please remember to quote the product code followed by the configuration code as shown in the diagram below:

## The construction of a water and dual fuel radiator product and configuration code:

WGCHYH041100

K916O1

PRODUCT CODE  
(located in the table for the product)

CONFIGURATION CODE  
(supplemented by hand)

### Example Configuration

**K** **916** **O1**

Package code  
*K - carton box*

Colour code

Connection code

## Epoxy primer

**E** – Code of epoxy primer is an extra processes.

WGCHYH041100 K916O1 **E** — *Extraprocesses or additions code*

# Cyklon H



## Legend



Radiator available in a "water" version.



Radiator suitable for dual fuel connection. Electric heating element can be installed.



Radiator available in electric only version. It comes prefilled with a 'heating medium' and equipped with a heating element. All tested and ready to use.



Connection types dedicated for this radiator. The icon shows the flow and return connections for the radiator as well as the thermostatic valve and heating element position if applicable.



Suggested heating element power output for electric and dual fuel versions.



Weight.



Capacity.



Available in chrome finish.



No additional payment for a color.