

Stand



Stand 1150↓ × 400↔ SX
colour: RAL 3020

3-axis thermostatic valve set, left, chrome
Integrated pipe-masking set, chrome
Wooden shelf, oak



TERMA
SINCE 1990



Stand



Standard connection:



Optional connection:

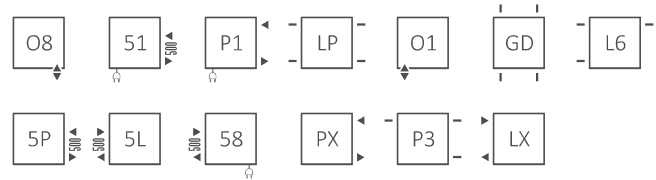

Available sizes:

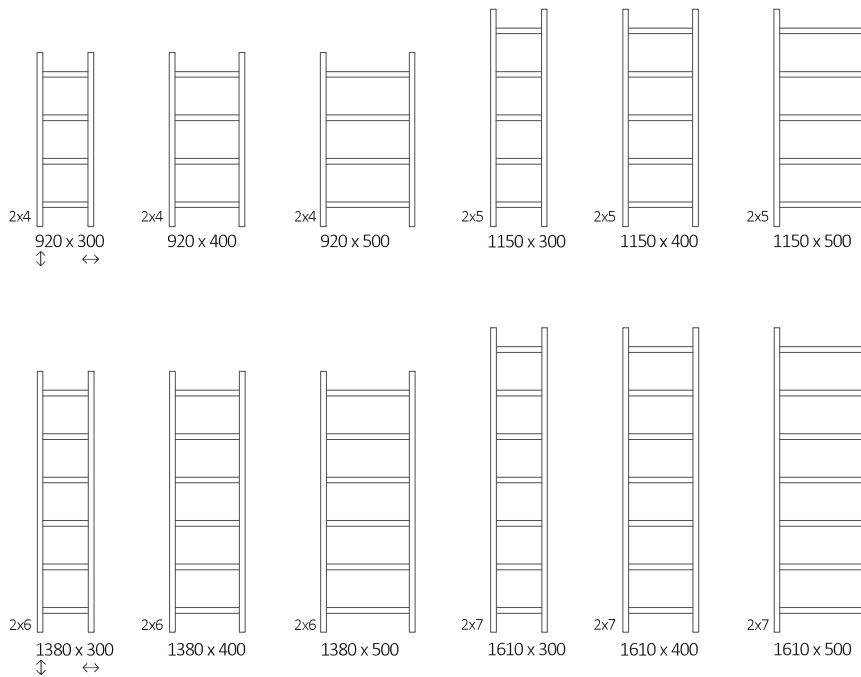

Specification:

Working pressure: 800 kPa Maximum operating temperature: 95°C

A ↓ [mm]	B ↔ [mm]	C2 [mm]	75/65/20°C [W]	55/45/20°C [W]	 [W]	D [mm]	E [mm]	F [mm]	 [dm³]	 [kg]	Product code <small>Configuration code p. 5</small>
920	300	270	383	207	400	270	915	115	5,29	8,81	WGSCA092030
920	400	370	434	234	400	370	915	115	5,87	9,88	WGSCA092040
920	500	470	486	262	600	470	915	115	6,45	10,96	WGSCA092050
1150	300	270	480	259	400	270	1145	115	6,56	10,86	WGSCA115030
1150	400	370	547	295	600	370	1145	115	7,28	12,20	WGSCA115040
1150	500	470	615	331	600	470	1145	115	8,00	13,55	WGSCA115050
1380	300	270	577	310	600	270	1375	115	7,82	12,90	WGSCA138030
1380	400	370	660	355	600	370	1375	115	8,69	14,52	WGSCA138040
1380	500	470	743	399	800	470	1375	115	9,55	16,13	WGSCA138050
1610	300	270	674	362	800	270	1605	115	9,08	14,96	WGSCA161030
1610	400	370	773	415	800	370	1605	115	10,09	16,83	WGSCA161040
1610	500	470	872	468	800	470	1605	115	11,10	18,71	WGSCA161050



Technical drawing:

SX

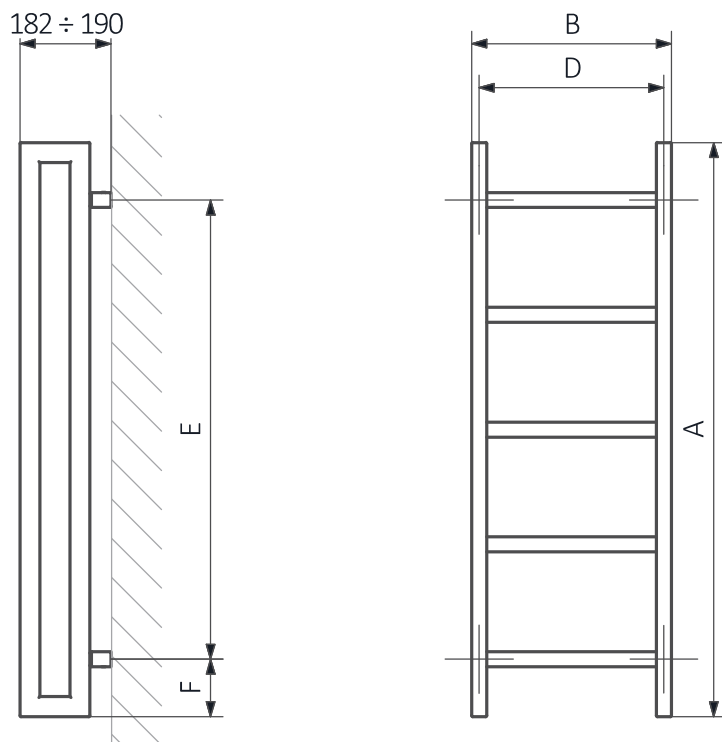
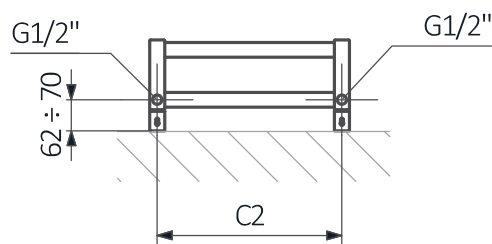

A – Height B – Width C1-C5 – Distance between pipe centres D – Horizontal distance between mounting bracket centres
E – Vertical distance between mounting brackets F – Distance between a mounting bracket and the bottom of the radiator

Collector:

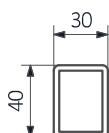

Pipe:

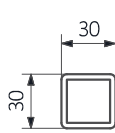



In the table with technical data, the last column lists product codes. When placing an order, please remember to quote the product code followed by the configuration code as shown in the diagram below:

The construction of a water and dual fuel radiator product and configuration code:

WGSCA092030

PRODUCT CODE
(located in the table for the product)

K916SX

CONFIGURATION CODE
(supplemented by hand)

Example Configuration

K **916** **SX**

Package code

K - carton box

Colour code

Connection code

Epoxy primer

E - Code of epoxy primer is an extra processes.

WGSCA092030 K916SX **E** — *Extra processes or additions code*



Legend



Radiator available in a "water" version.



Radiator suitable for dual fuel connection. Electric heating element can be installed.



Radiator available in electric only version. It comes prefilled with a 'heating medium' and equipped with a heating element. All tested and ready to use.



Connection types dedicated for this radiator. The icon shows the flow and return connections for the radiator as well as the thermostatic valve and heating element position if applicable.



Suggested heating element power output for electric and dual fuel versions.



Weight.



Capacity.



Available in chrome finish.



No additional payment for a color.

Stand shelf

Wooden shelf Stand:



Technical drawing:

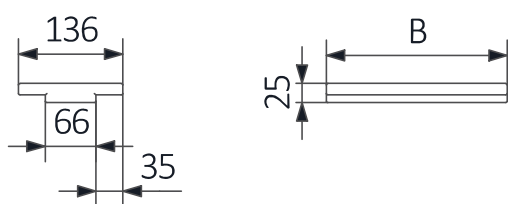

Available material:

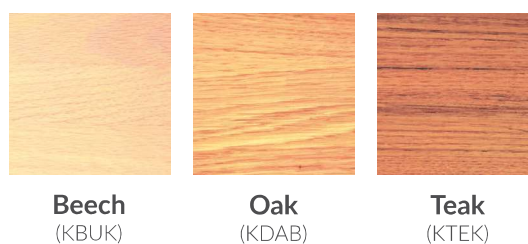

Specification:

Shelf	B ↔	Product code
STAND Shelf 300 mm	236	WRPSCA030
STAND Shelf 400 mm	336	WRPSCA040
STAND Shelf 500 mm	436	WRPSCA050

Product codes can be found in product data sheet tables. The codes provide some basic information about the product while a partially filled configuration code contains complementary information about the detailed specifications. When placing an order, product codes should include the fully completed configuration part. The configuration code part should be placed after the main product code. The main product code and configuration part will appear as shown in the example below:

The construction of a configuration code Stand shelf

WRPSCA040

PRODUCT CODE

(located in the table for the product)

KDAB

CONFIGURATION CODE

(supplemented by hand)

Example Configuration

K DAB

Package code
K - carton box

Colour code