



Air purifier

Floor standing or desktop type

Model

MC55WVM

Air Purifier OPERATION MANUAL



- Thank you for purchasing this air purifier.
 - Please read the operation manual carefully and follow it for correct use.
 - **Please read the “Safety Precautions” section before use.** ▶Page 3-5
- Please keep the operation manual in a safe place for later reference.

English

Deutsch

Français

Nederlands

Español

Italiano

Ελληνικά

Polski

Русский

Türkçe

Features

Streamer Technology



This technology employs a "streamer discharge", a type of plasma discharge comprising high-speed electrons with powerful oxidative capacity, that is generated inside the air purifier. The discharge swiftly removes odours. (The high-speed electrons are generated and then adsorbed within the unit to ensure your safety.)

Streamer discharge decomposes adsorbed odour.
Decomposition cycle that maintains deodorising capacity.

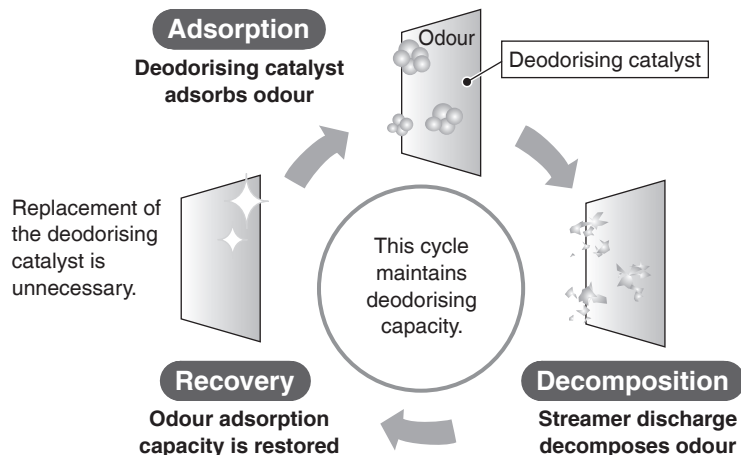

Streamer operation is conditional on the degree of air impurity.

During operation, the streamer discharge may generate a hissing sound, however, this does not indicate an abnormality. In addition, the sound may lessen or change in tone depending on the operating environment, however, such changes are normal. In some cases the air outlet may emit a slight odour as trace amounts of ozone are generated. However, the amount is negligible and is not harmful to your health.

Active Plasma Ion Technology

"Plasma ion" technology releases ions into the air by plasma discharge and combines them with components in the air to generate active compounds such as OH radicals with strong oxidising power. A technology that adheres to and acts on the surface of substances such as mould and allergens.

■ **Suppression mechanism provided by active plasma ions (image)**

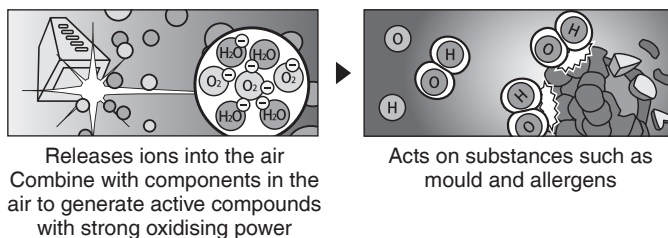

Controlling PM2.5

Elimination of 99% of 0.1-2.5µm particles (*1).

- Does not take into account inflow of new particles from outdoors owing to ventilation etc.
- PM2.5 is a generic term for particulate matter that is 2.5µm or less in size.
- Elimination of particulate matter that is less than 0.1µm in size by this air purifier has not been verified.

This product cannot eliminate all airborne toxic substances.

(*1) Test methodology: The Japan Electrical Manufacturers' Association standard (JEM1467)

Decision criteria: Elimination of 99% of 0.1-2.5µm particulate matter in a 32m³ airtight space in 90 minutes or less.

Equivalent value for 32m³ test space.

Substances that can be controlled/broken down



Mould



Pollen



Allergens such as
dust mite droppings
and remains



Odours



Formaldehyde



Diesel
particulate
matter



NOx

Substances that can be trapped



Dust



Yellow sand

Contents

Read First

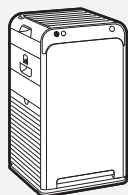

Features	1
Safety Precautions	3
Precaution During Use	5
Names of Parts and Operations	6
Preparation Before Operation.....	9

Operation

Using Air Purifying Operation	12
Changing the Airflow Rate	12

Useful Functions

Operating the Unit in a MODE	13
AUTO FAN / ECONO / ANTI-POLLEN	
Using the Child Proof Lock	15
Adjusting Indicator Lamp Brightness	15

Advanced Settings

Streamer Output Settings	16
Active Plasma Ion Output Settings	16
Dust / PM2.5 Sensor Sensitivity Setting	17
Settings of Modes within ECONO MODE	18

Maintenance

Maintenance	19
Streamer Unit Replace	21
Separately Sold Part	22
When Not Using the Unit for a Prolonged Period	22



Troubleshooting

About the Indicator Lamps	23
FAQs	24
Troubleshooting	25
Specifications	28

Safety Precautions

■ Observe these precautions in order to prevent property damage or injury.

■ The consequences of incorrect use are categorised as follows:



 WARNING	 CAUTION
Failure to follow these instructions properly may result in personal injury or loss of life.	Failure to follow these instructions properly may result in property damage or personal injury, which may be serious depending on the circumstances.

■ Precautions to be observed are categorised using symbols:

 Never attempt.	 Be sure to follow the instructions.
--	---

 **WARNING** Observe in order to prevent fire, electric shock or severe injury.

■ Concerning the power supply plug and cord

-  • **Do not unplug while the unit is in operation.** (Fire due to overheating or electric shock may result)
 -  • **Do not plug in or unplug with wet hands.** (An electric shock may result)
 - **Do not use in such a way that the ratings of the power socket or wiring appliances are exceeded or use a voltage outside of the range AC220-240V.**
(Fire may result from overheating if the ratings of multi-socket power adapters, etc., are exceeded)
 - **Do not pull on the power supply cord when unplugging.** (Overheating or fire may result from wire breakage)
 - **Do not perform actions that might break the power supply plug and cord.**
– Such actions including damaging, modifying, forcibly bending, pulling, twisting, bundling up, placing heavy objects on the power supply plug or cord.
If the power supply plug or cord is damaged, it must be replaced by the manufacturer, its service agent, or a similar qualified person in order to avoid a hazard. (An electric shock, short circuiting or fire may result from use while damaged)
-
-  • **Insert the power supply plug firmly all the way in.**
– Do not use a damaged power supply plug or a loosely fitted power socket.
(Electric shock, short circuiting or fire due to overheating may result if the power supply plug is not firmly inserted)
 - **Periodically wipe dust off the power supply plug with a dry cloth.**
– If the unit is not to be used for a prolonged period, unplug the power supply.
(Fire may be caused by defective insulation resulting from dust buildup with moisture, etc.)
 - **When performing maintenance, inspecting or moving the unit, be sure to turn off and unplug the unit.** (An electric shock or injury may result)

■ Do not use in the following places

-  • **Places where oil or flammable gases are used or may leak.** (Fire or smoke may result from ignition or suction toward the unit, or injury may result from degradation or cracking of plastic)
- **Places where there are corrosive gases or metal dust particles.**
(Fire or smoke may result from ignition or suction toward the unit)
- **Places where temperature and humidity levels are high or water may scatter, such as a bathroom.** (Fire or an electric shock may result from electrical leakage)
- **Places accessible to small children.** (An electric shock or injury may result)

⚠ WARNING Observe in order to prevent fire, electric shock or severe injury.

■ **During use**

- ⊘ • **Do not use chlorinated or acidic detergents.** (Injury may result from degradation or cracking of plastic, or harm may be caused to health from the production of toxic gases)
- **Keep burning cigarettes or incense sticks away from the unit.**
(Fire or smoke may result from ignition or suction toward the unit)
- **Do not attempt to disassemble, reconstruct or repair the unit yourself.**
(Fire, an electric shock or injury may result) For repairs, please contact the place of purchase.
- **Do not insert fingers, sticks, or any other item, into the air inlets or air outlet.**
(An electric shock, injury or damage may result)
- **Do not pour water onto the air outlet or the unit.** (Fire or an electric shock may result)
- **Do not use flammable substances (hair spray, insecticide, etc.) near the unit.**
Do not wipe the unit with benzine or thinner. (An electric shock, fire or cracking may result)

■ **Concerning the remote controller**

- ⊘ • **Do not place the remote controller in places that can be reached by small children.**
(Bodily harm may result from misoperation of the unit or accidental ingestion of the battery)
- **Make sure not to put the battery in the wrong polarity (+/-) orientation.**
(Short circuiting, fire or battery leakage may result)

■ **Immediately turn off and unplug the unit if there are any signs of abnormality and malfunction**

⚠ **Examples of abnormality and malfunction**

- The unit does not operate even if the switch is turned on.
 - Current passes through the cord or fails to pass through if the cord is moved.
 - There are abnormal sounds or vibrations during operation.
 - The casing of the unit has become deformed or is abnormally hot.
 - There is a burnt smell. (Malfunction, an electric shock, smoke, fire, etc., may result if the abnormality is not addressed and the unit continues to be used)
- Contact the place of purchase.

⚠ CAUTION Observe in order to prevent electrical leakage, injury or property damage.

■ **During use**

- ⊘ • **Small children or immobile persons (due to illness or injury) should not operate the unit by themselves.**
 - ◆ **For EU, Turkey:**
This appliance can be used by children aged from 8 years and above and persons with reduced physical, sensory or mental capabilities or lack of experience and knowledge if they have been given supervision or instruction concerning use of the appliance in a safe way and understand the hazards involved.
Children shall not play with the appliance. Cleaning and user maintenance shall not be made by children without supervision.
 - ◆ **For other regions:**
This appliance is not intended for use by persons (including children) with reduced physical, sensory or mental capabilities, or lack of experience and knowledge, unless they have been given supervision or instruction concerning use of the appliance by a person responsible for their safety.
- Children should be supervised to ensure that they do not play with the appliance.
- Persons who are heavily intoxicated or have taken sleep medication should not operate the unit.
(An electric shock, injury or poor health may result)

Safety Precautions

⚠ CAUTION Observe in order to prevent electrical leakage, injury or property damage.

- ⊘ **Do not use products that contain fine powder, such as cosmetics, near the unit.**
(An electric shock or malfunction may result)
 - **Do not operate the unit when fumigating insecticide is in use.**
 - After using insecticide, be sure to sufficiently ventilate the room before operating the unit.
(Harm may be caused to health from an outflow of accumulated chemical compounds from the outlet)
 - **Do not use the unit near a smoke detector.**
 - If the air coming out of the unit flows in the direction of the smoke detector, the response of the smoke detector may be delayed or it may fail to detect smoke.
-
- ⓘ **Frequently ventilate the room when using the unit together with combustion-based heating devices.**
 - Usage of this product is not a substitute for ventilation. (Potential cause of carbon monoxide poisoning)
This product cannot eliminate carbon monoxide.
 - **If the unit is placed within reach of a pet, be careful that the pet does not urinate on the unit or chew on the power supply cord.** (Fire, an electric shock or injury may result)

■ Concerning the unit body

- ⊘ **Do not block the air inlets or air outlet with laundry, cloth, curtains, etc.**
(Overheating or fire may result from poor circulation)
- **Do not climb, sit or lean on the unit.** (Injury may result from falling or toppling)

■ When moving the unit

- ⓘ **When picking up the unit to move it, handle the unit with caution.**
 - Be sure to always hold the unit using the correct grip locations. Do not hold the unit using the grip on the deodorising filter unit. (Injury may result from the unit falling)

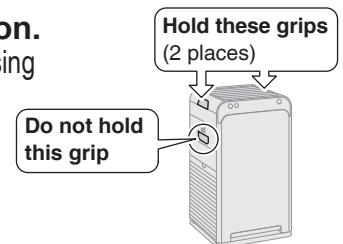

CJOR002EU

Precaution During Use

Other consideration

- **Do not use this product for special purposes such as in the preservation of works of art, academic texts/materials, etc.**
(Degradation of preserved items may result)

About streamer discharge and active plasma ions

In some cases the air outlet may emit a slight odour as trace amounts of ozone are generated. However, the amount is negligible and is not harmful to your health.

This product cannot eliminate all of the toxic substances in tobacco smoke (carbon monoxide etc.)

Names of Parts and Operations

⚠ CAUTION

Do not lift up the unit holding the grip on the deodorising filter unit. (Injury may result from the unit falling)

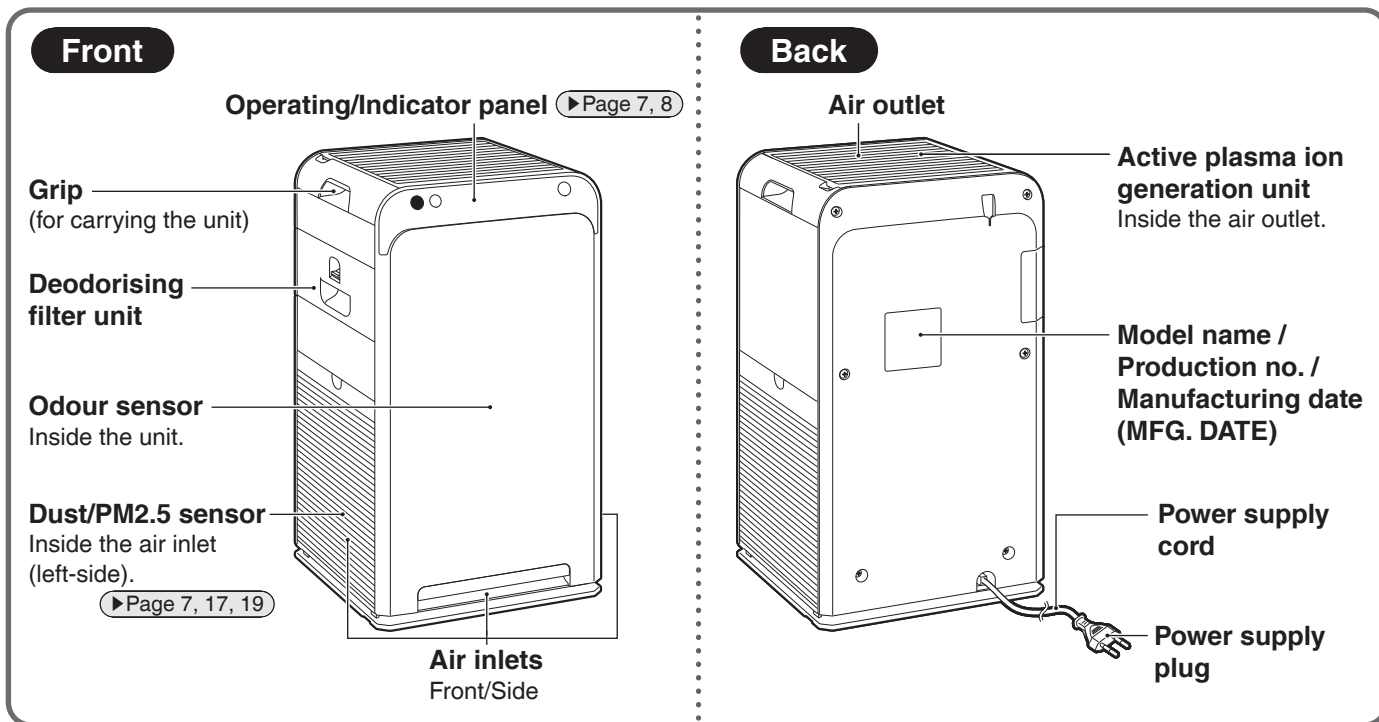

Main Removable Parts

Attention

To prevent malfunction, be sure to only operate the unit with all parts attached.

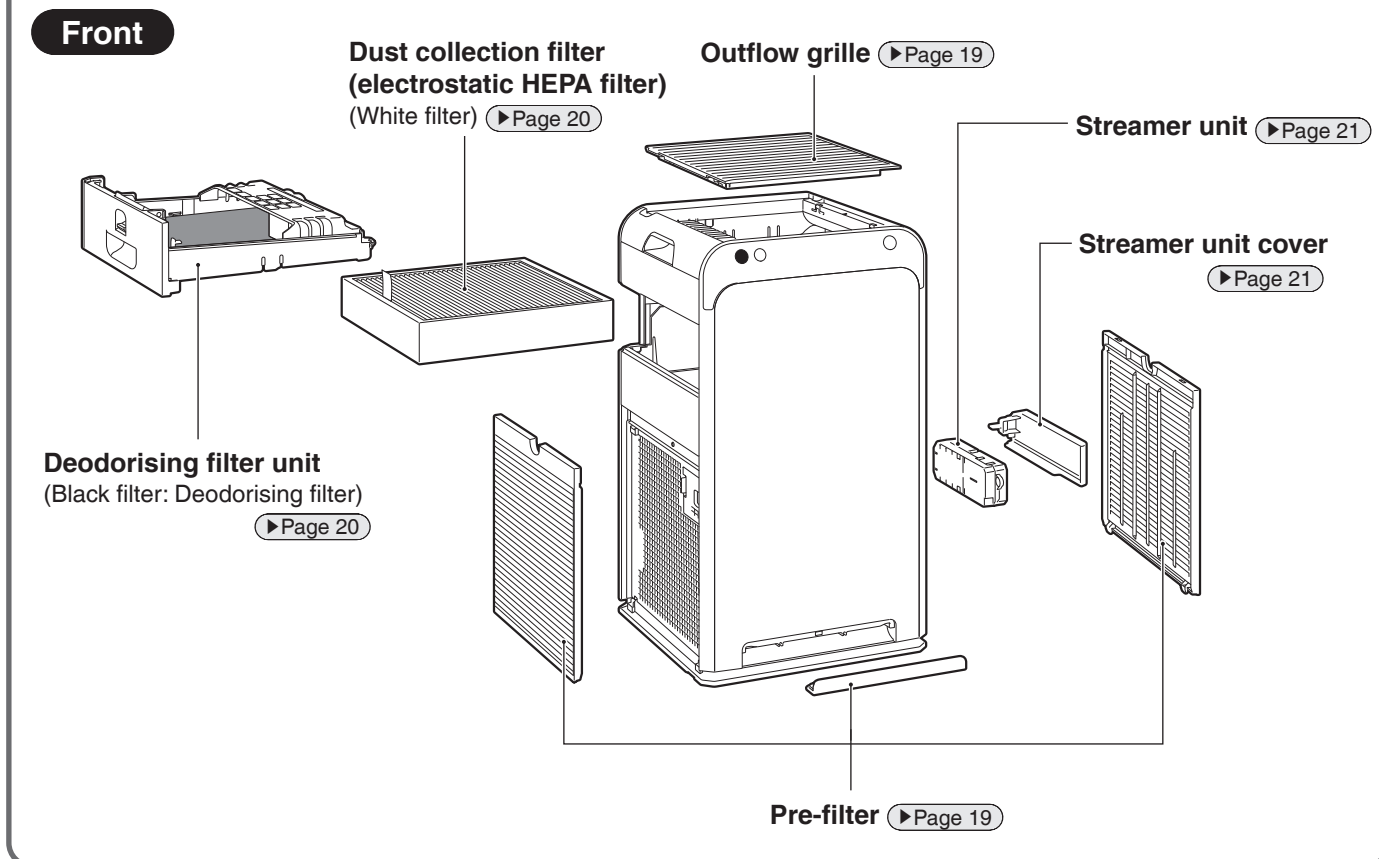

Names of Parts and Operations

Operating/Indicator panel

When a lamp is blinking [▶Page 23](#)

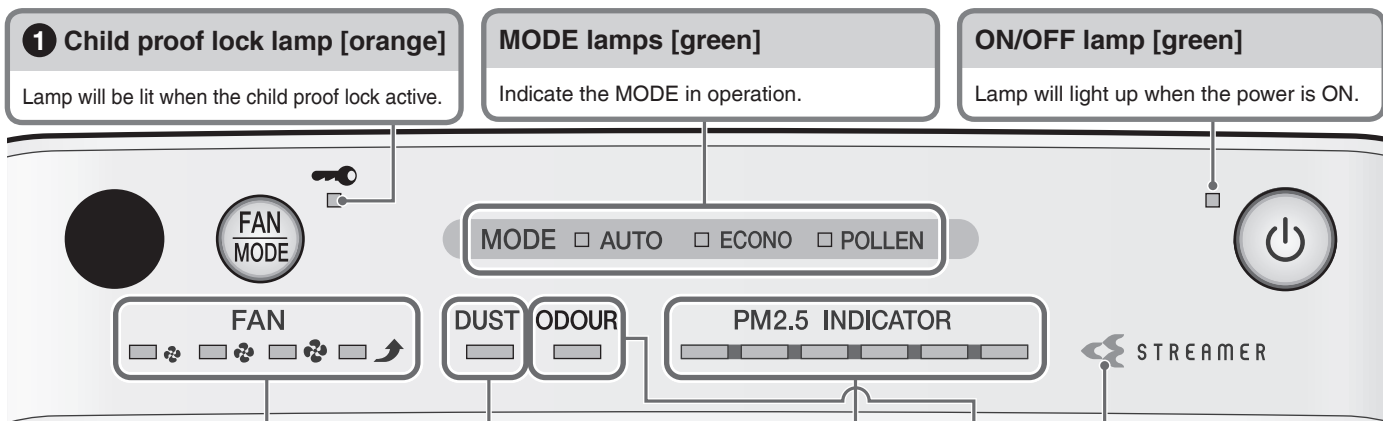

1 Child proof lock lamp [orange]

Lamp will be lit when the child proof lock active.

MODE lamps [green]

Indicate the MODE in operation.

ON/OFF lamp [green]

Lamp will light up when the power is ON.

FAN lamps [green]

Indicate the active FAN setting (4 settings: Quiet, Low, Standard, Turbo).

2 Streamer lamp [blue]

Lights up when the streamer is active.

3 Dust sensor lamp / PM2.5 INDICATOR lamps

Indicate the volume of dust in the ambient air.

- Green indicates that the air is clean.
- The dust/PM2.5 sensor can detect small (approx. 1.0-2.5µm) and large (approx. 2.5µm and above) dust particles. The PM2.5 INDICATOR lamps light in response to small particles and the dust lamp lights in response to large dust particles.

[Dust sensor lamp]



[PM2.5 INDICATOR lamps]



4 Odour sensor lamp

Indicates the intensity of odours in 3 colours: green, orange, red.

- Green indicates that the air is clean.

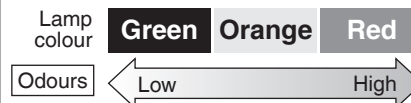

1 About the child proof lock lamp

- When lit up, operations will be restricted. When buttons are pressed, only a tone (3 short beeps) will sound, preventing misoperation by small children. [▶Page 15](#)

2 About the streamer lamp

- During streamer operation, this lamp lights up. Streamer operation is conditional on the degree of air impurity.
- If the hissing sound generated by the streamer discharge or the odour of ozone bothers you, set streamer output to low. [▶Page 16](#)

3 About the dust sensor lamp / PM2.5 INDICATOR lamp

- After operation is started, the lamp will light green for the first minute (approx.) regardless of air impurity level.
- The responsiveness of the dust/PM2.5 sensor may be poor during FAN setting "Turbo" or when airflow is high in AUTO FAN MODE. The strong airflow causes dust to be drawn into the air inlets before it can be detected by the dust/PM2.5 sensor. This is normal (not a malfunction).
- If the responsiveness of the dust/PM2.5 sensor is poor, change the sensitivity setting of the sensor. [▶Page 17](#)

Dust/PM2.5 sensor detection range

Detectable matter
house dust, tobacco smoke, pollen, mite droppings and remains, pet hairs, diesel particulate matter
Sometimes detectable
steam, oil smoke

4 About the odour sensor lamp

- If operation is started immediately after the power supply plug is inserted, the lamp will light green for the first minute (approx.).
- If odour intensity levels are unchanging, the sensor may not respond even if there is a strong odour in the air.
- The following types of odours may not be detected: pet odours that do not include ammonia, garlic odours, etc.
- As odour perception varies by person, in some cases an odour may be sensed even when the lamp is green. If the odour bothers you, switch to manual airflow rate, and select a high airflow rate. [▶Page 12](#)

Odour sensor detection range

Detectable matter
tobacco odours, cooking odours, pet odours, toilet smells, waste smells, mould odours, sprays, alcohol
Sometimes detectable
sudden changes in temperature/humidity, steam, oil smoke, gas emitted from combustion-based heating devices

The basic sensitivity of the odour sensor will be determined by odour levels in the first minute (approx.) after the power supply plug is inserted every time. Insert the power supply plug when the air is clean (odour-free).

Operating/Indicator panel

Signal receiver

Receives signals from the remote controller. Receiving tones sound when signals are received, confirming successful reception.

- Operation start...2 short beeps
- Setting change...1 short beep
- Operation end...1 long beep

FAN/MODE button

Press to cycle between FAN settings and MODEs. ▶Page 12-14

ON/OFF button

Press to turn the power ON or OFF. ▶Page 12

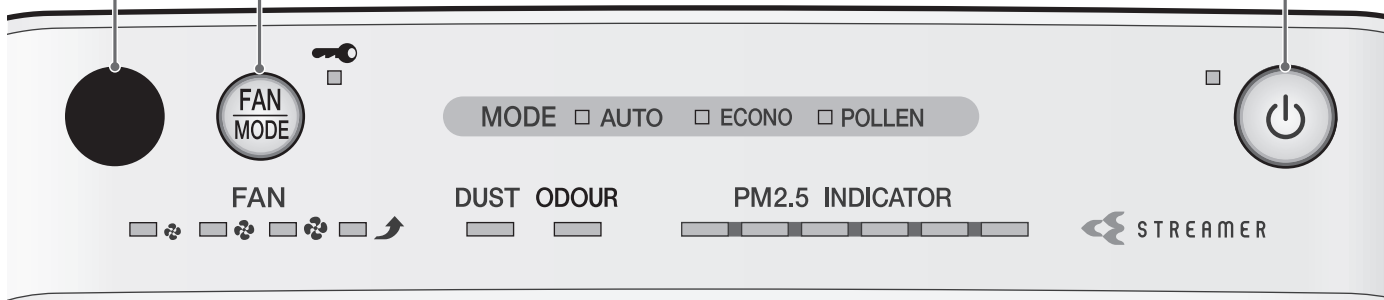

Remote controller

Signal transmitter

- Transmits signals to the unit.
- The unit may fail to receive signals if anything is blocking the signals, such as a curtain.
- Maximum transmission range is approx. 6m (straight line).

ON/OFF button

Press to turn the power ON or OFF. ▶Page 12

MODE button

Press to cycle between MODEs. ▶Page 13, 14

FAN button

Press to cycle between FAN settings. ▶Page 12

BRIGHTNESS button

Press to cycle through brightness levels (BRIGHT, DIM, OFF*). ▶Page 15

LOCK button

Prevents misoperation by small children. ▶Page 15

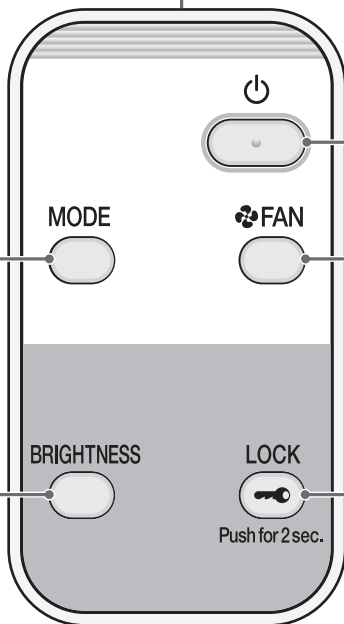

Accessories

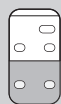

Remote controller 1



Remote controller holder..... 1

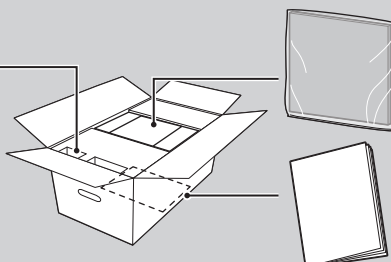

Deodorising filter 1
Attach to the unit before operation.

Operation manual 1
In the bottom of the packing case.

Preparation Before Operation

1 Positioning the unit

Before setting up, remove the fixing tape on the bottom which is securing the power supply cord, then take out the power supply cord.

Power supply cord
Fixing tape (blue)

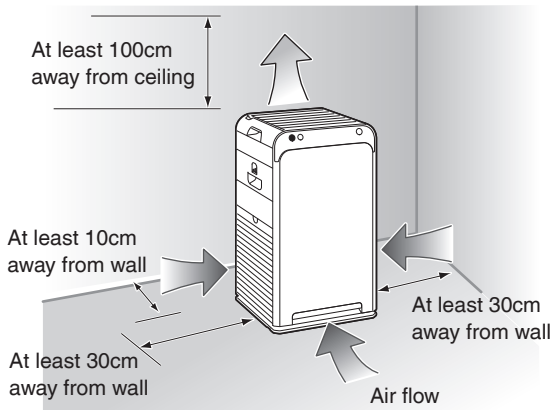
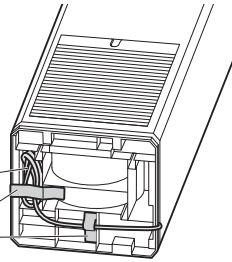

Pointers for good positioning

- Choose a position from where airflow can reach all areas of the room.
- Place on a stable surface. If the unit is placed on an unstable surface, vibrations from the unit may be amplified.
- If interference from the power circuit inside the unit or cables causes disturbance of TV screen images or the emission of static noise from nearby radios or stereos, move the unit to at least 2m away from the device.
Keep cordless phones and radio-controlled clocks away from the unit also.

Attention

- To avoid staining of walls, position the unit in accordance with the positioning measurements in the illustration. However, note that since this unit draws in dirty air, certain types of wall may become stained even if the measurements are adhered to. In such cases, be sure to maintain sufficient distance between the unit and the wall.
- When used for a prolonged period in the same location, the floor and surrounding walls may become stained as air is drawn into air inlets near the base of the unit. Periodic cleaning is recommended.

Do not use in the following places

- **Places exposed to direct sunlight**
(A decline in the receptivity of the signal from the remote controller or discolouration may result)
- **Positions near combustion-based heating and other high temperature devices**
(Discolouration/deformation due to overheating may result)
- **Places where chemicals and pharmaceuticals are used such as hospitals, factories, laboratories, beauty salons, and photographic laboratories**
(Volatilised chemicals and solvents may degrade mechanical parts and lead to malfunction)
- **Places with high levels of electromagnetic waves such as near an electromagnetic cooker, speakers, etc.**
The unit may not function correctly.
- **Places exposed to soot (conductive dust) released by candles, aromatic candles, etc.**
The performance of the filters may be impaired, causing the room to become dirty due to the build-up of dust that is not captured.

Do not use cosmetics etc., containing silicone* near the unit.

- * Hair care products (split ends coating agents, hair mousse, hair treatment agents etc.), cosmetics, antiperspirants, antistatic agents, waterproof sprays, lustering agents, glass cleaners, chemical wiping cloths, wax, etc.
- Insulators such as silicone may adhere to the needle of the streamer unit, and the streamer discharge may not be generated.
- The dust collection filter may become clogged up, resulting in loss of air purifying capacity.

Do not use an ultrasonic humidifier or similar appliance near the unit.

The dust collection filter may become clogged up, resulting in loss of air purifying capacity.

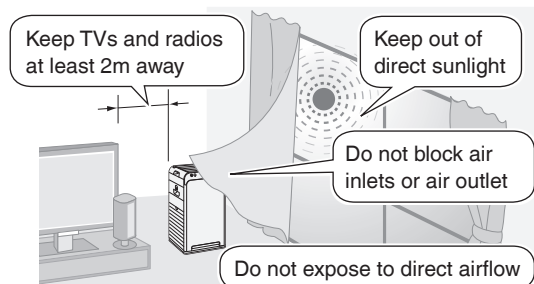

Carry out these steps before inserting the power supply plug.

2 Attaching the deodorising filter

1. Remove the deodorising filter unit from the main unit. ▶Page 20

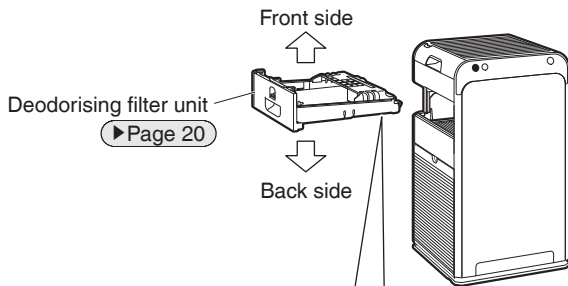

Back side of the deodorising filter unit

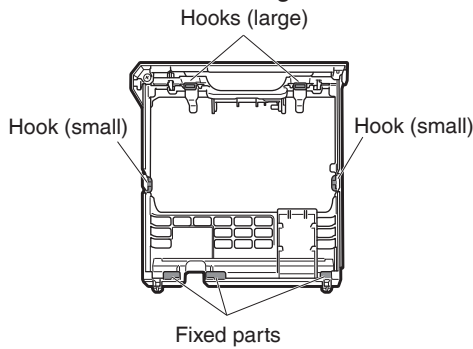

2. Remove the deodorising filter from the bag.

Wear gloves to prevent dust from the deodorising filter making hands dirty.

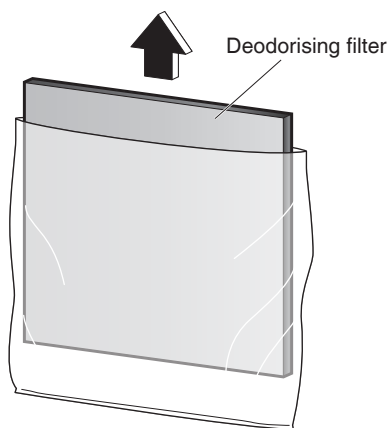

3. Turn the deodorising filter unit over and attach the deodorising filter.

- ① Set the deodorising filter under the fixed parts (3 places).
- ② While spreading the frame, set the deodorising filter under the hooks (small) in 2 places.

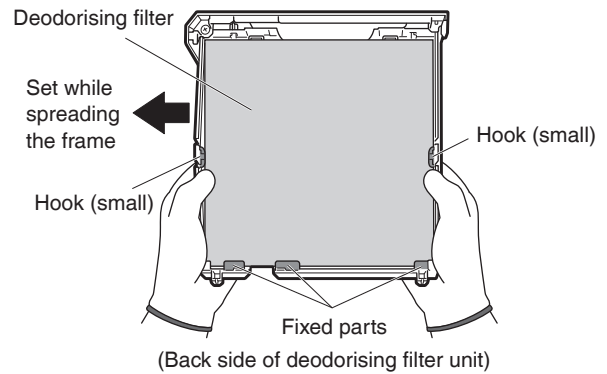

- ③ While pressing the protrusions on the hooks (large) on the front side of the deodorising filter unit, push the deodorising filter in and set it under the hooks (large) in 2 places to attach.

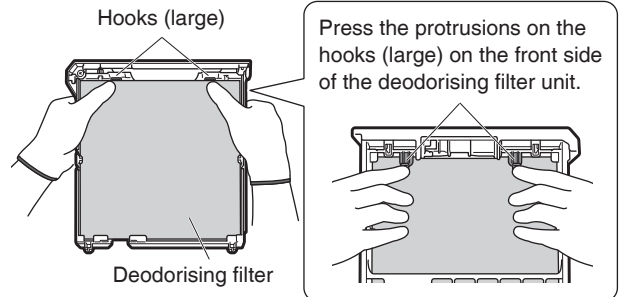

(Back side of deodorising filter unit)

- ④ Double check that the deodorising filter is set under the hooks (large).

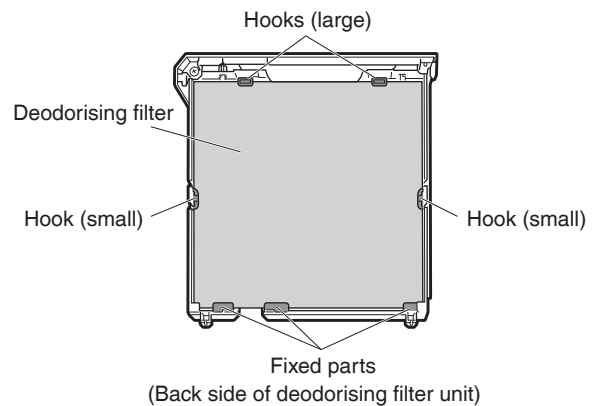

4. Install the deodorising filter unit into the main unit. ▶Page 20

- When starting operation, if the odour sensor lamp blinks, the deodorising filter is not properly attached.
- Observe local waste separation rules when disposing of the filter bag and desiccant.



Preparation Before Operation

3 Preparing the remote controller

1. Attach the remote controller holder.

- Insert the hook on the remote controller holder into the notch in the back of the unit.

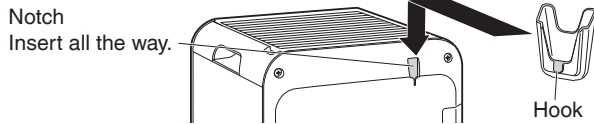

2. Pull out the transparent sheet.

- After removing the transparent sheet, the remote controller is ready for use.

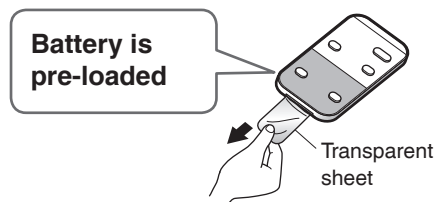

How to use

- Direct the signal transmitter on the remote controller at the signal receiver on the unit. The unit may fail to receive signals if anything is blocking the signals, such as a curtain.
- Maximum transmission range is approx. 6m (straight line).

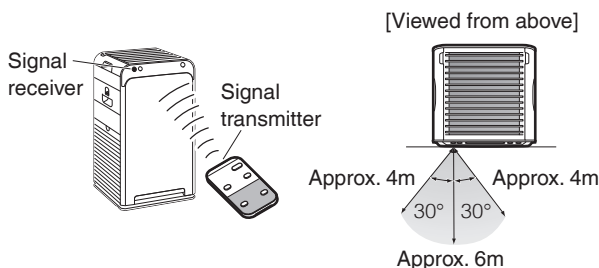

About the remote controller

- Be sure not to drop or allow water to get into the remote controller. (Malfunction may result)
- Signal reception may be poor in rooms with electronic-starter-type fluorescent lamps (inverter-type fluorescent lamps etc.).
- Do not use near lighting equipment (within 1m). (A decline in the receptivity of the signal from the remote controller or discolouration may result)

Replacing the battery

1. Move the catch on the battery tray at the bottom of the remote controller in the direction of the arrow.
2. Pull out the battery tray.
3. Replace the battery.
4. Return the battery tray to its original position.

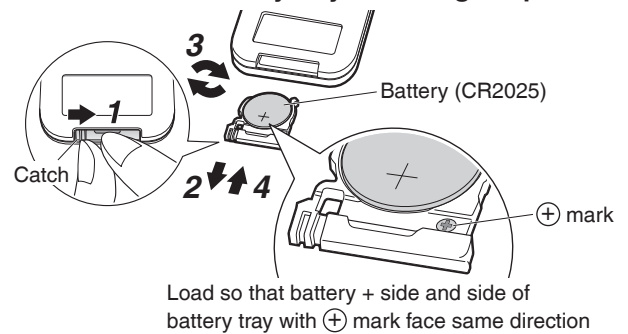

About the battery

- Keep batteries out of reach of children. In the event that batteries are swallowed, go immediately to the nearest medical emergency services.
- To avoid possible injury or damage from battery leakage or rupturing, remove the battery when not using the product for a prolonged period.
- If the battery solution should get in the eyes, do not rub the eyes. Instead, immediately flush the eyes with tap water and seek the attention of a medical professional.
- Do not expose batteries to heat or fire. Do not disassemble or modify batteries. The insulation or other parts inside the battery may be damaged, resulting in battery leakage, rupturing or overheating.
- When disposing of the battery, insulate the terminal by wrapping it in tape etc. (Overheating, rupturing or fire may result if stored together with other metal objects or batteries) Observe local waste separation rules when disposing of batteries.
- While the general battery replacement timing is once a year, if signal reception weakens, the battery should be replaced with a new battery (CR2025).
- Batteries with an expiration date that is close may require replacement sooner.
- The pre-loaded battery is for initial use of the unit and may require replacement in less than 1 year.

4 Inserting the power supply plug into the socket

- The basic sensitivity of the odour sensor will be determined by odour levels in the first minute (approx.) after the power supply plug is inserted every time.
- Insert the power supply plug when the air is clean (odour-free).**

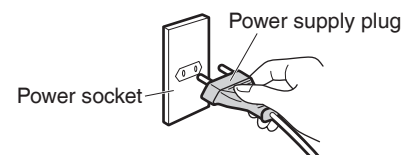

! WARNING

Do not turn off the unit by unplugging it from the power socket.
(Fire due to overheating or electric shock may result)

Operation

Operation

Remote controller

Operation via remote controller.

Unit

Operation via operating/indicator panel on unit.

Detailed settings can be made using the remote controller.

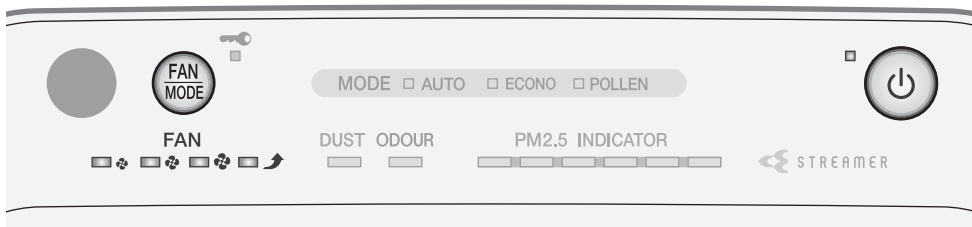
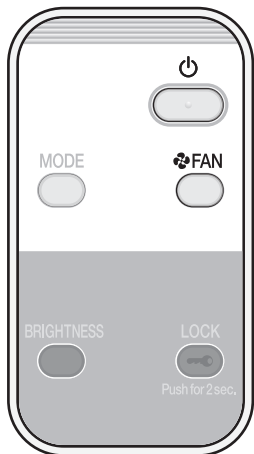

Using Air Purifying Operation (turning operation ON/OFF)

Purifies the air in the room.

Remote controller

Press .

- Press again to turn OFF.
- ON/OFF lamp [green] lights up.

Unit

Press .

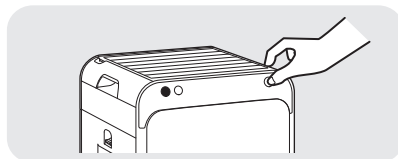

Attention

- Do not move the unit, or attach or remove parts to/from the unit while it is in operation. Breakage or malfunction may result.

Note

- At the time of purchase, the unit is set to Air purifying operation, AUTO FAN MODE with active plasma ion generation set to ON.
- When the unit is unplugged or turned OFF, it will operate with the settings last used the next time it is turned ON.
- Operation settings cannot be changed for about 2 seconds immediately after the power supply plug is inserted.

Changing the Airflow Rate

Select the desired FAN setting.

: Quiet : Low : Standard : Turbo * The size of the symbols varies in accordance with the FAN setting.

Remote controller

Press .

- Each press cycles between the FAN lamps [green].

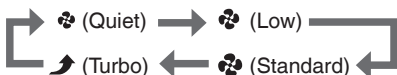

Unit

Press .

- Each press cycles between the FAN lamps [green] and MODE lamps [green].

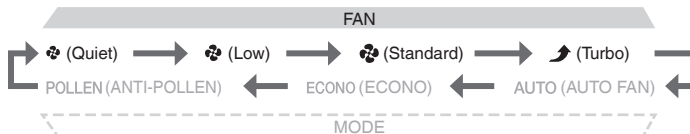

About FAN settings

- Quiet** A gentle breeze is emitted. Recommended for use during sleep hours. As the deodorising capacity is reduced, it is recommended that the FAN setting be set to Standard or above if odour needs to be quickly eliminated from a room.
- Turbo** The ambient air is quickly purified using a large airflow. Recommended for use while you are cleaning up a room.

Useful Functions

Remote controller

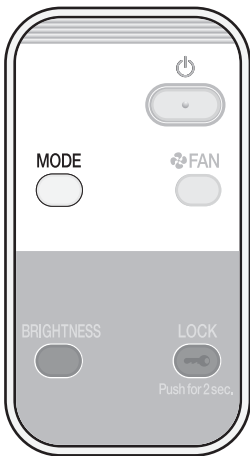

Unit

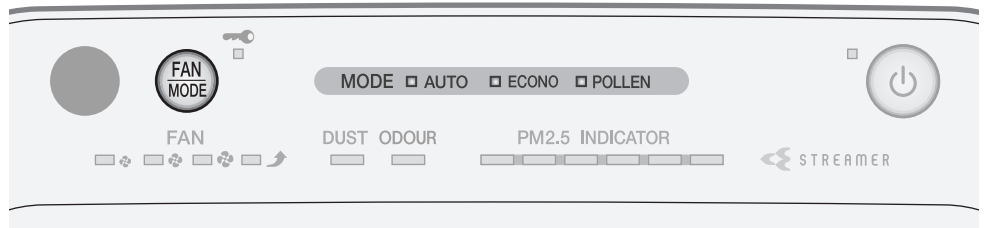

Operating the Unit in a MODE

Select a MODE specific to your needs.
Airflow is adjusted automatically when the unit is running in a MODE.

Remote controller

Press .

- Each press cycles between the MODE lamps [green].



Unit

Press .

- Each press cycles between the MODE lamps [green] and FAN lamps [green].

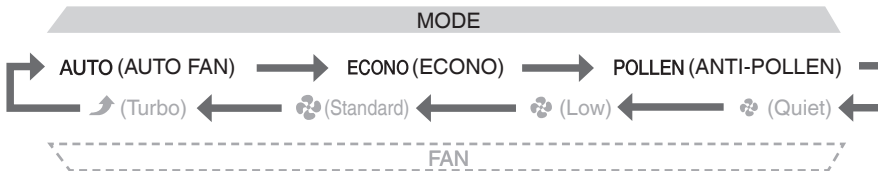

MODE	Usage and Function
AUTO FAN	<p>Automatic airflow rate adjustment</p> <p>FAN setting (Quiet, Low, Standard, High) is automatically adjusted according to the degree of air impurity. Purifying capacity increases as airflow rate rises.</p> <ul style="list-style-type: none"> Degree of air impurity corresponds to the volume of dust and the intensity of odours in the ambient air.
ECONO	<p>Saving energy</p> <p>In Power saving mode within ECONO MODE, the FAN setting automatically switches between Quiet and Low only. Power consumption (*1) and operating sounds are reduced. If the air is clean, after a short while, Monitoring mode automatically activates. Recommended for use during sleep hours.</p> <p>*1 By comparison to AUTO FAN MODE (approx. 10.3Wh), power consumption in ECONO MODE (approx. 6.7Wh) is approx. 3.6Wh lower. Test conditions: operation in 10m² area over 1 hour. Assuming 1 cigarette was smoked immediately after the unit was turned on.</p> <div style="display: flex; justify-content: space-between; align-items: center;"> <div data-bbox="328 1081 635 1335" style="border: 1px solid black; border-radius: 10px; padding: 10px; width: 30%;"> <p>Power saving mode</p> <p>FAN setting switches automatically between Quiet and Low.</p> </div> <div data-bbox="675 1104 903 1323" style="text-align: center; width: 30%;"> <p>If the air is clean, after a short while...</p>  <p>If dust or odours are detected...</p> </div> <div data-bbox="943 1081 1437 1335" style="border: 1px solid black; border-radius: 10px; padding: 10px; width: 30%;"> <p>Monitoring mode</p> <ul style="list-style-type: none"> The fan starts and stops periodically. Dust and odours are monitored. The following functions are turned off, further reducing power consumption. <p>Streamer OFF</p> <p>Active plasma ion OFF</p> </div> </div> <ul style="list-style-type: none"> As the FAN setting is limited to Quiet and Low, air purifying capacity is reduced. As air is not drawn in when the fan has stopped, the dust/PM2.5 sensor and odour sensor reduce in sensitivity. To prevent this reduction in sensitivity, turn Monitoring mode OFF. (▶Page 18) FAN setting is adjusted automatically. Airflow cannot be adjusted manually.
ANTI-POLLEN	<p>Reducing pollen levels</p> <p>A gentle air current is created by switching every 5 minutes between the FAN setting Standard and Low so that pollen can be drawn in and caught before it reaches the floor.</p> <ul style="list-style-type: none"> FAN setting is adjusted automatically. Airflow cannot be adjusted manually.

Useful Functions

Remote controller

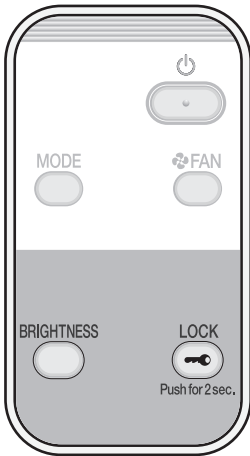

Unit

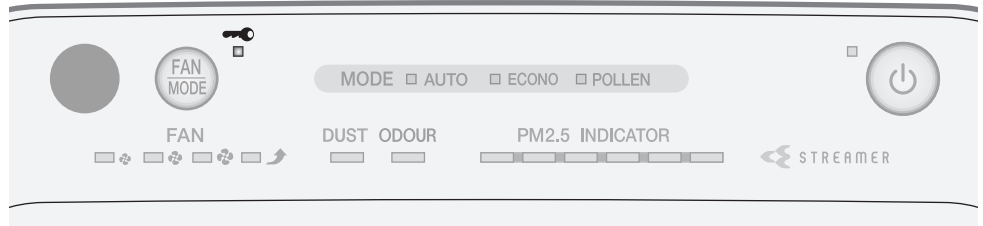

Using the Child Proof Lock

Button operation is restricted, preventing misoperation by small children.

Remote controller

Hold down  for about 2 seconds.

Unit

Cannot be set from unit.

• Hold down  for 2 seconds again to turn off child proof lock.

• When child proof lock is active, operations will be restricted. When buttons are pressed, only a tone (3 short beeps) will sound, preventing misoperation by small children.

Note

- If the unit is unplugged when child proof lock is active, child proof lock is turned off.
- The child proof lock lamp [orange] lights up when the function is active.

Adjusting Indicator Lamp Brightness

Indicator lamp brightness is adjustable.

Remote controller

Press  .

Unit

Cannot be set from unit.

• Press to cycle between settings.



Note

- This function is useful if the lamps bother you during sleep hours etc.
- The ON/OFF lamp does not turn off even if the brightness is set to OFF. This lamp will be set to DIM.
- If any of the below buttons are pressed when brightness is set to OFF, brightness will change to DIM and return to OFF after about 10 seconds.



Advanced Settings

If the hissing sound generated by the streamer discharge or the odour of ozone bothers you

*Setting at time of purchase



Streamer Output Settings

Regular*

Low

Setting procedures **Remote controller**

Hold down  and  for about 3 seconds with the power supply plug inserted and the unit turned off.

- Each time  and  are held down for about 3 seconds, the setting switches between Regular and Low.

[When the setting is changed to Low]

A short beep sounds and the streamer lamp blinks for about 5 seconds.



[When the setting is changed to Regular]

A short beep sounds and the streamer lamp lights up for about 5 seconds.



Operation status of streamer

FAN/MODE setting		Streamer output setting	
		Regular	Low
FAN	Quiet, Low	ON-OFF*	OFF
	Standard		ON-OFF*
	Turbo	ON	ON
MODE	AUTO FAN, ANTI-POLLEN	ON-OFF*	ON-OFF*
	ECONO		OFF

*The streamer operation status ON-OFF means that the streamer turns ON and OFF automatically depending on the degree of air impurity and FAN setting.

- The streamer lamp turns off when streamer operation is OFF.

Note

- It is recommended that the streamer be set to Regular as deodorising capacity is reduced when set to Low.
- Settings are remembered even if the unit is unplugged.

When you want to turn off active plasma ion output

*Setting at time of purchase

Active Plasma Ion Output Settings

ON*

OFF

Setting procedures **Remote controller**

Hold down  and  for about 3 seconds with the power supply plug inserted and the unit turned off.

- Each time  and  are held down for about 3 seconds, the setting switches between ON and OFF.

[When the setting is changed to OFF]

A short beep sounds and the dust lamp and odour sensor lamp blink green for about 5 seconds.



[When the setting is changed to ON]

A short beep sounds and the dust lamp and odour sensor lamp light up green for about 5 seconds.



Note

- Settings are remembered even if the unit is unplugged.
- If set to OFF, active plasma ion discharge stops, however, dust and odour removal continues.
- If the odour of ozone bothers you, set active plasma ion output to OFF.**
- If the odour of ozone continues to bother you even after output has been set to OFF, set streamer output to Low.

Advanced Settings



When the sensitivity of the dust/PM2.5 sensor does not meet your preferences

*Setting at time of purchase

Dust / PM2.5 Sensor Sensitivity Setting



High	Normal*	Low
------	---------	-----

Setting procedures **Remote controller** **Unit**

1. Hold down  **on the unit for about 5 seconds and when a short beep sounds, press**  **on the remote controller while pressing**  **on the unit.**

- This setting change can be performed when the unit is on or off.

2. Release both buttons when a short beep sounds.

- One of the FAN lamps ( (Low),  (Standard),  (Turbo)) will blink for about 5 seconds and then the lamp corresponding to the currently set sensitivity will light up.

3. Press  **on the unit to change the sensitivity setting.**

- Each press cycles between the FAN lamps allowing you to change the sensitivity.

To set sensitivity **High**

▶ Select the FAN lamp  (Turbo).

To set sensitivity **Low**

▶ Select the FAN lamp  (Low).

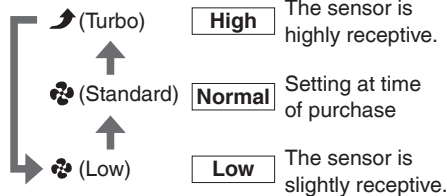

- Setting is indicated using the FAN lamps. If the FAN lamps do not change, unplug the unit, wait at least 5 seconds, then re-insert the power supply plug and repeat the above procedure from the beginning.

4. Press  **on the remote controller after selecting the new setting.**

- A short beep sounds and the new setting will blink. Unplug the unit while the lamp is blinking, wait at least 5 seconds, and then re-insert the power supply plug. Setting is now complete.
- If this procedure is not performed, the unit will not return to regular operation mode.

Note

- Settings are remembered even if the unit is unplugged.



If you want to turn Monitoring mode (within ECONO MODE) OFF

*Setting at time of purchase

Settings of Modes within ECONO MODE

Monitoring ON*	Monitoring OFF
----------------	----------------

Setting procedures **Remote controller** **Unit**

1. Hold down  on the unit for about 5 seconds and when a short beep sounds, press  on the remote controller while pressing  on the unit.

- This setting change can be performed when the unit is on or off.

2. Release both buttons when a short beep sounds.

- The FAN lamp  (Quiet) and ECONO MODE lamp will light up after blinking for about 5 seconds. The ECONO MODE lamp will light up or blink depending on the ON/OFF status of Monitoring mode.

3. Press  on the unit to change the setting.

- Each press turns the ECONO MODE lamp ON or OFF. (The FAN lamp  (Quiet) will remain lit up.)

To turn Monitoring mode **ON**
▶ Turn on the ECONO MODE lamp.

 ECONO **ON** Setting at time of purchase

To turn Monitoring mode **OFF**
▶ Turn off the ECONO MODE lamp.

ECONO **OFF**

- Setting is indicated using the ECONO MODE lamp. If the ECONO MODE lamp does not change, unplug the unit, wait at least 5 seconds, then re-insert the power supply plug and repeat the above procedure from the beginning.

4. Press  on the remote controller after selecting the new setting.

- A short beep sounds and the FAN lamp  (Quiet) will blink. When Monitoring mode is turned ON, the ECONO MODE lamp also blinks. Unplug the unit while the lamp is blinking, wait at least 5 seconds, and then re-insert the power supply plug. Setting is now complete.
- If this procedure is not performed, the unit will not return to regular operation mode.

Note

- Settings are remembered even if the unit is unplugged.

! WARNING

Before cleaning and maintenance work, be sure to unplug the unit. (An electric shock or injury may result)

Maintenance

Outflow Grille

When dirt becomes an issue

Wipe

Wash/Rinse

- Wipe up dirt with a soft damp cloth and rinse with water.
- Do not use a hard brush etc. (Damage may result)
- When dirt buildup is severe, leave the part soaking in lukewarm or room temperature water mixed with kitchen-use neutral detergent, thoroughly rinse off the detergent, and leave the part in shade to dry off.

Removing

Place fingers into the notches in the top of the unit and lift.

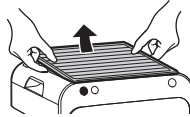

Attaching

Pay attention to orientation and attach securely.

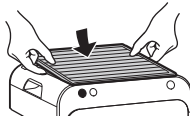

Unit

When dirt becomes an issue

Wipe

- Wipe up dirt with a soft damp cloth.
- When dirt buildup is severe, wipe up the dirt with a cloth which has been moistened with kitchen-use neutral detergent.
- Do not use a hard brush etc. (Damage may result)

Pre-filter (Front/Left-side/Right-side)

About every 2 weeks

Vacuum clean

Wash/Rinse

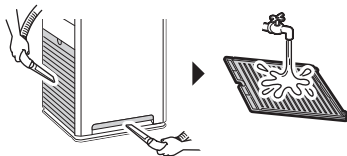

- After removing any dust using a vacuum cleaner, remove and wash the filter with water and then leave it in shade to dry off.
- Use a soft brush when cleaning the spaces in the grid.

Attention

- Do not use a cotton bud or hard brush etc. (Partial breakage of the filter may result)
- Do not apply heavy force. (Partial breakage/damage of the filter may result)
- When dirt buildup is severe, leave the part soaking in lukewarm or room temperature water mixed with kitchen-use neutral detergent, thoroughly rinse off the detergent and leave the part in shade to dry off.

Removing

Grip the notch in the pre-filter and pull.

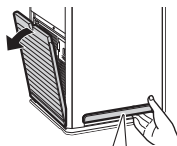

- ① Grip either end of the pre-filter resting your thumb against the unit.

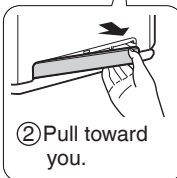

- ② Pull toward you.

Attaching

Insert the hooks (2 places) into the unit and press until you hear a catching sound.

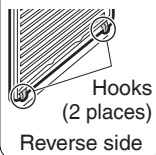

Hooks (2 places)
Reverse side

Insert the hook (1 place) into the unit. Push both ends until securely attached.

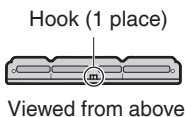

Hook (1 place)
Viewed from above

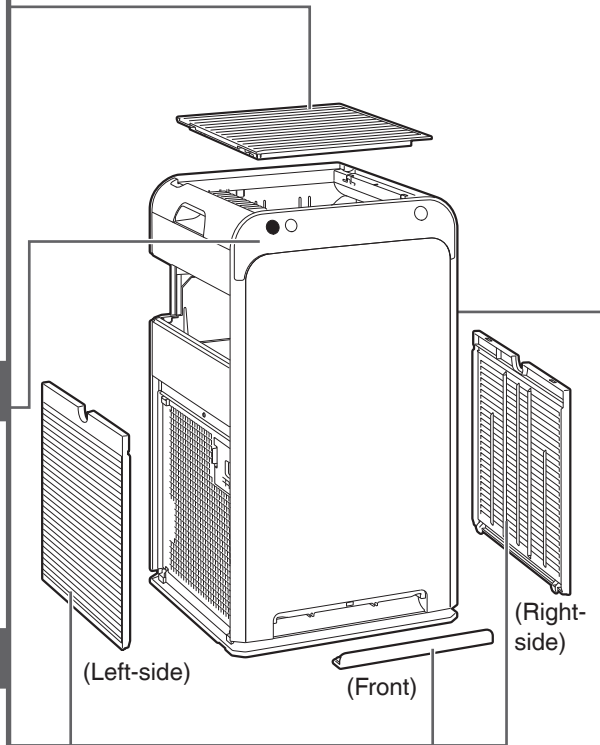

Dust/PM2.5 Sensor

When dust has built up

Vacuum clean

- ① Remove the pre-filter (left-side).
- ② Vacuum off any dust that has adhered to the air intake for dust/PM2.5 sensor using the vacuum cleaner crevice tool or similar.

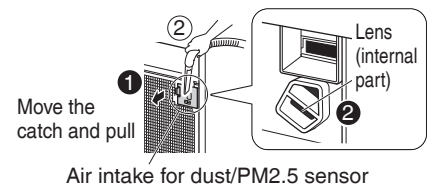

Air intake for dust/PM2.5 sensor

About every 3 months **Wipe**

- ① Remove the pre-filter (left-side) and the cover for the air intake for dust/PM2.5 sensor.

- ② Wipe the lens with a dry cotton bud.

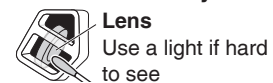

Lens
Use a light if hard to see

Use the vacuum cleaner crevice tool or similar to remove any dust that has built up around the lens.

- ③ Place the cover on securely. (Malfunction may result if the cover is off)

! WARNING

- Do not use petrol, benzine, thinner, polishing compound, paraffin, alcohol, etc. (An electric shock, fire or cracking may result)
- Do not wash the main unit with water. (An electric shock, fire or malfunction/breakage may result)

Deodorising Filter Unit

When odour or dirt becomes an issue

Vacuum clean **Do not use water**

- Remove from the unit together with the frame and remove dust using a vacuum cleaner.
- **If odour becomes an issue, leave the part in a shaded, breezy area. (about 1 day)**
- Do not scrub the surface.
- Do not use water when cleaning. (If water is used, the part will lose its shape and become unusable.) ▶Page 24

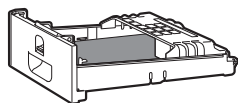

Do not detach the deodorising filter from frame

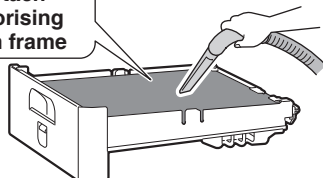

Removing

- Hold the lever and grip of the deodorising filter unit and remove.

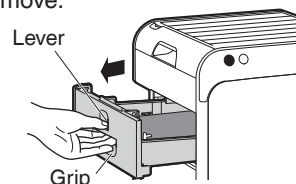

Attaching

- Fully insert the deodorising filter unit.

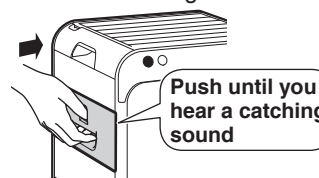

- If the deodorising filter unit is detached or not properly attached, the odour sensor lamp will blink.

Dust Collection Filter

About every 10 years Replace

Do not use water **Do not vacuum clean**

- Do not use a vacuum cleaner or use water when cleaning. (If the filter is damaged or holes are opened etc., dust will pass through the filter and capacity for dust collection will be reduced.)

About part replacement timing

- Replacement timing depends on usage patterns and the location of the unit. Standard replacement time is about 10 years assuming that the unit is used daily in a home where 5 cigarettes are smoked a day. (Calculation in accordance with testing method of Japan Electrical Manufacturers' Association JEM1467 standard) If the impurity content of the ambient air is high, the filter will need more frequent replacement. Replace the dust collection filter if the filter is failing to perform.

About purchasing and disposal

- Refer to "Separately Sold Part". ▶Page 22

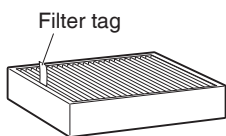

Removing

- ① Remove the deodorising filter unit.
- ② Pull the filter tag upward.
- ③ Hold the lower part of the dust collection filter and lift it out.

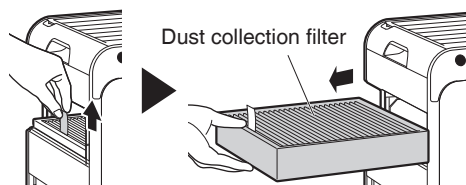

Attaching

- ① Install a new dust collection filter, paying attention to the orientation.

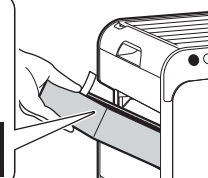
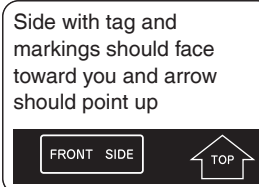

- ② Attach the deodorising filter unit.

Attention

- Make sure that the dust collection filter and deodorising filter unit are attached to the main unit when the unit is operating. If these parts are not attached when the unit is operated, malfunction/breakage may result.
- Observe in order to prevent discolouration or deformation.
 - If detergent is used, be sure to wipe it up thoroughly so none remains.
 - If warm water is used, make sure that it is 40°C or less.
 - Do not leave parts to dry in direct sunlight.
 - Do not dry parts using a dryer.
 - Do not apply fire to parts.
- If using a vacuum cleaner, be sure not to apply force to or hit the part. (Damage may result)

! WARNING

Before cleaning and maintenance work, be sure to unplug the unit. (An electric shock or injury may result)

Maintenance

Streamer Unit Replace

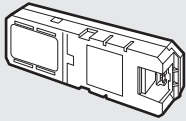

If the streamer lamp blinks

Basically, the streamer unit will not need to be replaced. However, depending on the location the unit is used (places where oils are present, or dust and humidity is abundant, or sprays and chemical agents are used, etc.), replacement may become necessary. [▶Page 23](#)

Contact the place of purchase.

1. Remove the pre-filter on the left side viewing from the back of the main unit. [▶Page 19](#)

2. Flip up the protective covers and remove the streamer unit cover.

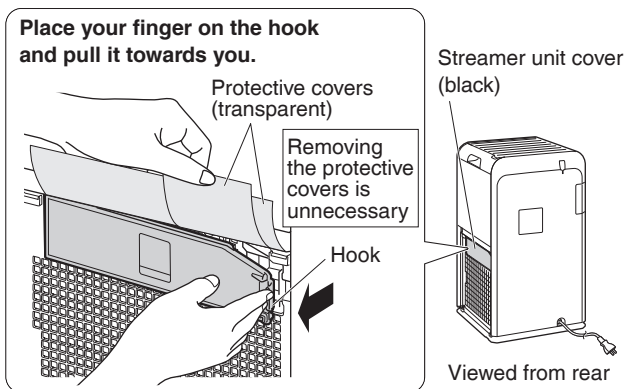

3. Remove the streamer unit.

① Remove the streamer unit connector.

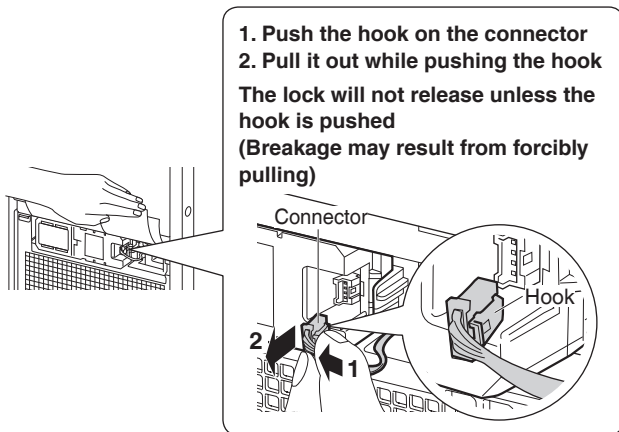

② Push in the left side of the streamer unit so the right side comes out.

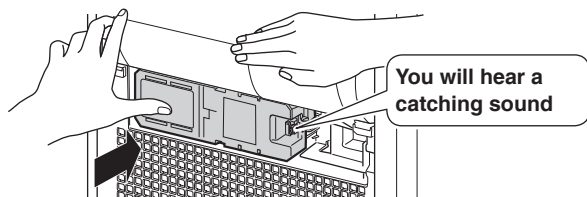

③ Remove the streamer unit.

4. Flip up the protective covers and attach the new streamer unit.

① First insert the streamer unit to the left, then push the right side until the hook makes a catching sound.

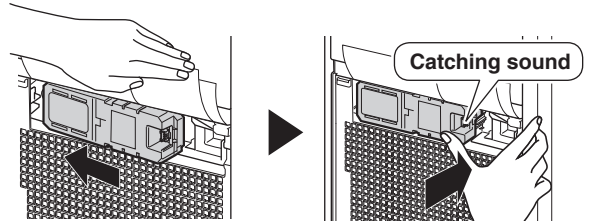

② Pay attention to the direction of the hook on the connector, making sure it is facing to the right, and fully insert the connector.

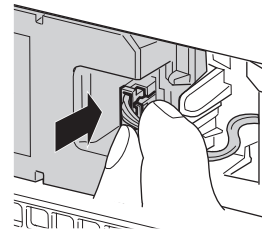

5. Flip up the protective covers and attach the streamer unit cover.

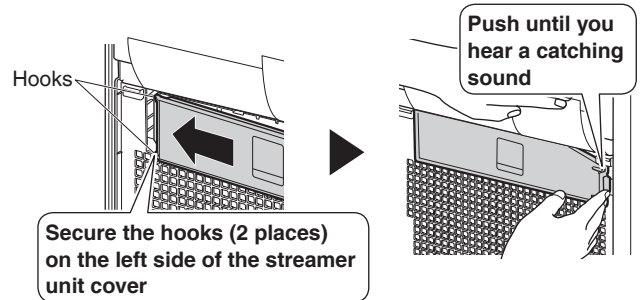

- Ensure you don't trap the connector cord.
- If the streamer unit cover is not properly attached the safety switch will engage, and the unit cannot operate.

6. Attach the pre-filter. [▶Page 19](#)

7. Insert the power supply plug while pressing **FAN MODE on the unit, and wait until a short beep sounds.**

- The streamer lamp will turn off.
- If you release **FAN MODE** and attempt operation before the short beep sounds, the streamer lamp will blink again.
- If you perform this step and the streamer lamp still blinks, check that the connector is properly inserted.

Separately Sold Part

Contact the place of purchase.

Replacement part

Dust collection filter (electrostatic HEPA filter) (1 piece)

Model: KAFP080B4E

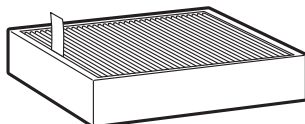

- Replace about every 10 years.
- Catches dust and pollen.

- Failure to maintain part properly may result in:
 - Reduced air purifying capacity
 - Reduced deodorising capacity
 - Emission of odours
- Observe local waste separation rules when disposing of the dust collection filter (made of polyester and polypropylene).

■ Disposal requirements



Your product and the batteries supplied with the controller are marked with this symbol. This symbol means that electrical and electronic products and batteries shall not be mixed with unsorted household waste. For batteries, a chemical symbol can be printed beneath the symbol. This chemical symbol means that the battery contains a heavy metal above a certain concentration. Possible chemical symbols are:

- Pb: lead (>0.004%)
- Hg: mercury (>0.0005%)

Disposal of this product must be done in accordance with relevant local and national legislation.

Units and waste batteries must be treated at a specialized treatment facility for re-use, recycling and recovery.

By ensuring correct disposal, you will help to prevent potential negative consequences for the environment and human health. Please contact the installer or local authority for more information.

When Not Using the Unit for a Prolonged Period





- 1. Unplug the power supply.**
- 2. Clean the parts.** [▶Page 19, 20](#)
 - In particular, parts cleaned with water should be completely dry. (Mould may result from remaining moisture)
- 3. Cover the air outlet and other openings with a plastic bag or similar to prevent dust entry, and store the unit upright in a dry place.**
(Malfunction/breakage may result from storing the unit upside down or horizontally)

About the Indicator Lamps

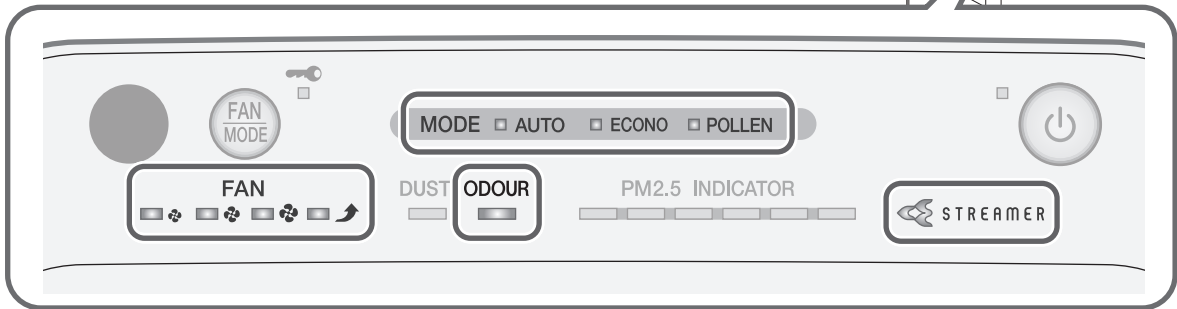
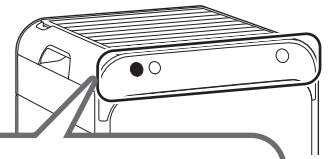
Operating/Indicator panel

Check the indicator lamps and respond as indicated below.

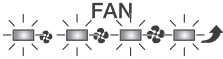

Indicator lamp	Cause/Solution	
<p>Odour sensor lamp blinks</p> 	<p>This lamp blinks if the deodorising filter unit has become detached or is not properly attached. → Attach the deodorising filter unit properly. ▶Page 20</p>	
<p>Streamer lamp blinks</p> 	<p>It is time to replace the streamer unit. ▶Page 21 This lamp blinks if the streamer unit has become detached or is not properly attached. → Attach the streamer unit properly. ▶Page 21</p>	
<p>All 3 MODE lamps blink at the same time</p> 	<p>An electrical component is faulty. → Contact the place of purchase.</p>	
<p>AUTO FAN MODE lamp is blinking</p> 	<p>An electrical component is faulty. → Contact the place of purchase.</p>	
<p>All 4 FAN lamps blink at the same time</p> 	<p>Are the pre-filter, outflow grille, and dust collection filter attached? These lamps may blink if the unit is operated without a part attached.</p>	<p>■ If all the parts are attached An electrical component is faulty. → Contact the place of purchase.</p> <p>■ If one or more parts are not attached Unplug the power supply, re-attach the parts and then turn the unit on again.</p>
	<p>Is there a buildup of dust on the pre-filter?</p>	<p>■ If there is no dust buildup An electrical component is faulty. → Contact the place of purchase.</p>
	<p>Is the air outlet blocked?</p>	<p>■ If there is dust buildup Unplug the power supply, clean the pre-filter and then turn the unit on again. ▶Page 19</p>
	<p>These lamps may blink if there is a sudden voltage fluctuation. ▶Page 26</p>	<p>■ If the air outlet is not blocked An electrical component is faulty. → Contact the place of purchase.</p> <p>■ If the air outlet is blocked Remove any obstacles blocking the air outlet and then turn the unit on again.</p>

FAQs

Please check the following before contacting the place of purchase.

Q: The dust/PM2.5 sensor seems to have poor sensitivity...

A: Perform periodic cleaning of the dust/PM2.5 sensor as dirt on its lens can lead to poor sensitivity. (▶Page 19)
 In addition, the response time of the dust/PM2.5 sensor depends on room size. Make adjustments in accordance with the procedure for setting dust/PM2.5 sensor sensitivity. (▶Page 17)
 The responsiveness of the dust/PM2.5 sensor may be poor during FAN setting "Turbo" or when airflow is high in AUTO FAN MODE.
 The strong airflow causes dust to be drawn into the air inlet before it can be detected by the dust/PM2.5 sensor. This is normal (not a malfunction).

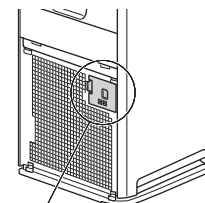

Dust/PM2.5 sensor

Q: Can the dust collection filter be cleaned?

A: No. Do not attempt to clean it with a vacuum cleaner or water.
 (Reduced performance of the dust collection filter may result)
 Replace it if dirt buildup is severe.

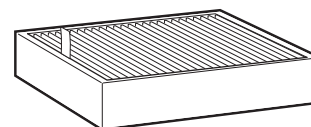

Q: The dust collection filter easily turns black...

A: The blackening does not affect dust collection performance. However, it can be replaced if it is an issue.

Q: Can the deodorising filter be cleaned with water? Or should it be replaced?

A: It cannot be cleaned with water.
 (If water is used, the part will lose its shape and become unusable.)
 If you have inadvertently washed it with water, contact the place of purchase.
 Remove the deodorising filter unit from the main unit and vacuum off dust with a vacuum cleaner.
 It is not necessary to replace the filter.
If odour becomes an issue, leave the part in a shaded, breezy area. (about 1 day) (▶Page 20)

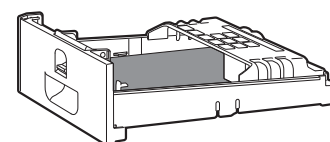

Troubleshooting

■ **Before making an inquiry or a request for repair, please check the following.**

If the problem persists, contact the place of purchase.

■ **In the event of malfunction during operation**

If the indicator lamps light up abnormally, or become inoperable, due to a lightning strike etc., remove the power supply plug, wait at least 5 seconds then re-insert the power supply plug and turn the unit on again.



Not a problem





This case is not a problem.





Check

Please check again before requesting repairs.

■ **Unit does not respond**













Phenomenon	Check points
No response even if  on the remote controller is pressed	<ul style="list-style-type: none">  Has the battery run out? → Replace the battery. ▶Page 11 Is a button on a remote controller for a TV, VCR or other appliance, stuck pressed down? → If a button on another remote controller is stuck pressed down because it is pressed against a remote controller rack etc., it may interfere with reception. Is there a device in the room that redirects remote controller signals? → Some appliances such as TV speakers are equipped with these devices. If there is such a device in the room, the signals it emits may interfere with signals from the remote controller, preventing reception.
	<ul style="list-style-type: none">  To protect the system, the unit may stop operating after a sudden voltage fluctuation. If operating at the time of the voltage fluctuation, operation will resume automatically once voltage returns to normal. Voltage range protection: 180V-264V
Unit will not operate	<ul style="list-style-type: none">  Is the streamer unit cover attached? If it is not attached, the safety switch will engage, and the unit cannot operate. → Install the streamer unit cover properly and attempt operation again. ▶Page 21

■ **Sounds can be heard**

Phenomenon	Check points
Hissing sound during operation	<ul style="list-style-type: none">  A hissing sound is generated when there is streamer discharge during streamer operation. Depending on usage conditions, the sound may lessen or change to a crackling, whirring or guzzling sound. However, this is normal. If the sounds are an issue, move the unit to a different location. ▶Page 16
Whistling and fluttering sound during operation	<ul style="list-style-type: none">  Is there a buildup of dust on the pre-filter? → Clean this part. ▶Page 19 Is the dust collection filter clogged up? → Depending on usage conditions, the dust collection filter may become clogged up, shortening its service life. ▶Page 9 Replace the dust collection filter. ▶Page 20
Operating sound is loud	<ul style="list-style-type: none">  Is the dust collection filter properly attached? → If it is not properly attached, operating sounds may become louder. ▶Page 20



■ **Indicator lamps**

Phenomenon	Check points
Indicator lamps do not light up Indicator lamps turn off about 10 seconds after the unit is turned on	<ul style="list-style-type: none">  Is indicator lamp brightness set to OFF? → If indicator lamp brightness is set to OFF, all lamps except the ON/OFF lamp will remain off. → If indicator lamp brightness is set to OFF, after the unit is turned on, the brightness of the indicator lamps will be DIM for about 10 seconds and then turn OFF. ▶Page 15







Phenomenon	Check points
<p>All the FAN lamps ( (Quiet),  (Low),  (Standard), and  (Turbo)) blink together</p>	<p> • Are the pre-filter, outflow grille, and dust collection filter attached? These lamps may blink if the unit is operated without a part attached. [If one or more parts are not attached] → Unplug the power supply, re-attach the parts and then turn the unit on again. [If all the parts are attached] An electrical component is faulty. → Contact the place of purchase.</p> <p>• Is there a buildup of dust on the pre-filter? [If there is dust buildup] ▶Page 19 → Unplug the power supply, clean the pre-filter and then turn the unit on again. [If there is no dust buildup] An electrical component is faulty. → Contact the place of purchase.</p> <p>• Is the air outlet blocked? [If the air outlet is blocked] → Remove any obstacles blocking the air outlet and then turn the unit on again. [If the air outlet is not blocked] An electrical component is faulty. → Contact the place of purchase.</p> <p> • These lamps may blink if there is a sudden voltage fluctuation. The lamps will return to their previous condition once voltage returns to normal. Voltage range protection: 180V-264V</p>
<p>The dust sensor lamp remains orange or red</p> <p>The PM2.5 INDICATOR lamp remain red, purple or brown</p>	<p> • Is there a buildup of dust in or around the air intake for the dust/PM2.5 sensor? → Vacuum off any dust from the air intake using a cleaner. ▶Page 19</p> <p>• Is the cover detached from the air intake for the dust/PM2.5 sensor? → Securely attach the cover. ▶Page 19</p> <p>• Is the lens for the dust/PM2.5 sensor dirty? → Wipe off dirt from the lens using a dry cotton bud or similar. ▶Page 19</p> <p>• Is the pre-filter dirty? ▶Page 19 → Clean these parts.</p> <p>After cleaning, the unit will return to normal operation a short while after being turned on.</p>
<p>There is an odour but the odour sensor lamp remains green</p>	<p> • Did an odour already exist around the time you inserted the power supply plug? → The basic sensitivity of the odour sensor will be determined by odour levels in the first minute (approx.) after the power supply plug is inserted every time. ▶Page 7</p> <p>To adjust the basic sensitivity of the odour sensor, unplug the power supply when the air is clean (odour-free), wait at least 5 seconds, then re-insert the power supply plug and turn the unit on again.</p>
<p>Sometimes the streamer lamp does not light up</p>	<p> • Depending on the degree of air impurity, streamer operation may turn OFF. The streamer lamp turns off when streamer operation is OFF. ▶Page 16</p> <p> • Is streamer output set to Low? → If it is set to Low, the length of time the streamer operates will be shorter than when streamer output is set to Regular. ▶Page 16</p> <p>• Is the unit operating in ECONO MODE? → The streamer lamp does not light up when the unit is in Monitoring mode. ▶Page 14</p>
<p>The streamer lamp blinks even though the streamer unit has been replaced</p>	<p> • After replacement, was the power supply plug inserted while pressing  on the unit? ▶Page 21</p> <p>• Is the streamer unit's connector properly installed? [In case of improper installation] → Unplug the power supply, re-attach the connector, and attempt operation again. ▶Page 21 [In case of proper installation] An electrical component is faulty. → Contact the place of purchase.</p>
<p>The odour sensor lamp blinks</p>	<p> • Is the deodorising filter unit attached? → Attach the deodorising filter unit. ▶Page 20</p>

Troubleshooting

■ Air purifying function

Phenomenon	Check points
Air purifying capacity is reduced	<ul style="list-style-type: none">  Is the unit surrounded by obstacles, or positioned in a place where airflow cannot reach? → Choose a position that is obstacle-free and from where airflow can reach all areas of the room. Is the pre-filter or dust collection filter dirty? → Clean these parts. (▶Page 19, 20)
The air outlet is emitting an odour	<ul style="list-style-type: none">  Is the deodorising filter dirty? → Clean the parts. (▶Page 20) In some cases the air outlet may emit a slight odour as trace amounts of ozone are generated. However, the amount is negligible and is not harmful to your health. Is the room filled with odours due to cooking or several people smoking together etc? → The odour will gradually fade as the unit operates. Have you moved the unit from another room? → The unit may emit the odour of the room in which it was used previously. Let the unit run a while longer. Is there anything in the room that is emitting an odour continuously? (Paint, new furniture, wallpaper, sprays, cosmetics, chemicals) → As continuously emitted odours cannot be completely eliminated, you should ventilate the room at the same time or run the unit in a well-ventilated room for a short while.
No air is being emitted	<ul style="list-style-type: none">  Is the air outlet or an air inlet blocked? If they are not blocked, an electrical component is faulty. → Contact the place of purchase.

■ Other

Phenomenon	Check points
The fan stops midway through unit operation	<ul style="list-style-type: none">  When the unit switches to Monitoring mode during operation in ECONO MODE, the fan turns on and off repeatedly. (▶Page 14)
	<ul style="list-style-type: none">  Are the pre-filter, outflow grille, and dust collection filter attached before the unit is operated? The fan is configured to stop in order to protect electrical components if a part is not properly attached. → If a part is not attached, unplug the unit and attach all the parts before turning the unit on again.
The sound of streamer discharge can no longer be heard	<ul style="list-style-type: none">  Depending on the degree of air impurity, streamer operation may turn OFF. (▶Page 16)
	<ul style="list-style-type: none">  Is streamer output set to Low? (▶Page 16)
There is interference on our TV screen	<ul style="list-style-type: none">  Is the TV or radio positioned within 2m of the unit, or is an indoor antenna positioned near the unit? Are the power supply cord or antenna cable of the TV or radio routed near the unit? → Keep the unit as far as possible from the TV, radio or antenna.
Just inserting the power supply plug causes operation to start	<ul style="list-style-type: none">  Did you disconnect the power supply plug during a power failure, or when a sudden voltage fluctuation occurred? Or did you stop the unit by disconnecting the power supply plug during the last operation? → The auto-restart function automatically resumes operation.

Specifications

Model name	MC55WVM			
Power supply	Single phase 50Hz 220-240V / 60Hz 220-230V			
Operation mode	Air Purifying			
	Turbo	Standard	Low	Quiet
Power consumption (W)	37	15	10	8
Operating sound (dB)	53	39	29	19
Airflow rate (m ³ /h)	330	192	120	66
Coverage area (m ²)	41			*1
External dimensions (mm)	500(H)× 270(W)× 270(D)			
Weight (kg)	6.8			
Power supply cord length (m)	1.8			

Made in China

- **These specification values are applicable to both 50Hz 220–240V and 60Hz 220–230V.**
- **Even when the power is off, approx. 1W of power is consumed to run the microcomputer.**

*1. Coverage area was calculated in accordance with JEM1467. (when FAN setting is “Turbo”)

DAIKIN INDUSTRIES, LTD.

Head office:
Umeda Center Bldg., 2-4-12, Nakazaki-Nishi,
Kita-ku, Osaka, 530-8323 Japan

Tokyo office:
JR Shinagawa East Bldg., 2-18-1, Konan,
Minato-ku, Tokyo, 108-0075 Japan
<https://www.daikin.com>

DAIKIN EUROPE N.V.

Zandvoordestraat 300, B-8400 Oostende, Belgium

DAIKIN ISITMA VE SOĞUTMA SİSTEMLERİ SAN. TİC. A.Ş.

Gülsuyu Mahallesi, Fevzi Çakmak Caddesi, Burçak Sokak No:20

34848 Maltepe / İSTANBUL / TÜRKİYE

Tel: 0216 453 27 00

Faks: 0216 671 06 00

Çağrı Merkezi: 444 999 0

Web: www.daikin.com.tr

The bar code is a manufacturing code.



3P595629-1

M19B160 (1912)HT

EAC

The two-dimensional bar code is
a manufacturing code.