

# TOSHIBA

## Installation Manual

R32

### Indoor Unit

Model name:

---

For commercial use

High-Wall Type

**RAV-HM561KRTP-E**

**RAV-HM801KRTP-E**

**RAV-HM901KRTP-E**

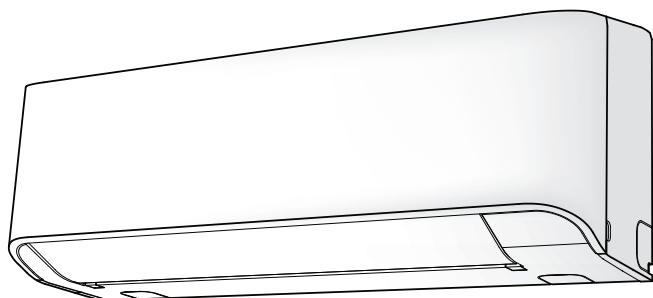

## Original instruction

Please read this Installation Manual carefully before installing the Air Conditioner.

- This Manual describes the installation method of the indoor unit.
- For installation of the outdoor unit, follow the Installation Manual attached to the outdoor unit.
- For precaution for safety, follow the Installation Manual attached to the outdoor unit.

### ADOPTION OF R32 REFRIGERANT

This Air Conditioner has adopted a refrigerant HFC (R32) which does not destroy the ozone layer. Be sure to check the refrigerant type for outdoor unit to be combined, and then install it.

#### Product information of ecodesign requirements. (Regulation (EU) 2016/2281)

<http://ecodesign.toshiba-airconditioning.eu/en>

## Contents

<b>1</b>	<b>PRECAUTIONS FOR SAFETY</b>	<b>5</b>
<b>2</b>	<b>ACCESSORY PARTS</b>	<b>11</b>
<b>3</b>	<b>SELECTION OF INSTALLATION PLACE</b>	<b>12</b>
<b>4</b>	<b>INSTALLATION OF INDOOR UNIT</b>	<b>14</b>
<b>5</b>	<b>CUTTING A HOLE AND MOUNTING INSTALLATION PLATE.</b>	<b>15</b>
<b>6</b>	<b>PIPING AND DRAIN HOSE INSTALLATION.</b>	<b>16</b>
<b>7</b>	<b>INDOOR UNIT FIXING.</b>	<b>20</b>
<b>8</b>	<b>DRAINAGE</b>	<b>20</b>
<b>9</b>	<b>REFRIGERANT PIPING</b>	<b>21</b>
<b>10</b>	<b>ELECTRICAL CONNECTION</b>	<b>24</b>
<b>11</b>	<b>APPLICABLE CONTROLS</b>	<b>30</b>
<b>12</b>	<b>TEST RUN.</b>	<b>40</b>
<b>13</b>	<b>MAINTENANCE.</b>	<b>44</b>
<b>14</b>	<b>TROUBLESHOOTING.</b>	<b>46</b>
<b>15</b>	<b>SPECIFICATIONS.</b>	<b>50</b>
<b>16</b>	<b>APPENDIX</b>	<b>53</b>

Thank you for purchasing this air conditioner.

Please read carefully through these instructions that contain important information which complies with the Machinery Directive (Directive 2006/42/EC), and ensure that you understand them.

After completing the installation work, hand over this Installation Manual as well as the Owner's Manual provided to the user, and ask the user to keep them in a safe place for future reference.

**Generic Denomination: Air Conditioner**

**Definition of Qualified Installer or Qualified Service Person**

The air conditioner must be installed, maintained, repaired and removed by a qualified installer or qualified service person. When any of these jobs is to be done, ask a qualified installer or qualified service person to do them for you.

A qualified installer or qualified service person is an agent who has the qualifications and knowledge described in the table below.

Agent	Qualifications and knowledge which the agent must have
Qualified installer	<ul style="list-style-type: none"> <li>• The qualified installer is a person who installs, maintains, relocates and removes the air conditioners made by Toshiba Carrier Corporation. He or she has been trained to install, maintain, relocate and remove the air conditioners made by Toshiba Carrier Corporation or, alternatively, he or she has been instructed in such operations by an individual or individuals who have been trained and is thus thoroughly acquainted with the knowledge related to these operations.</li> <li>• The qualified installer who is allowed to do the electrical work involved in installation, relocation and removal has the qualifications pertaining to this electrical work as stipulated by the local laws and regulations, and he or she is a person who has been trained in matters relating to electrical work on the air conditioners made by Toshiba Carrier Corporation or, alternatively, he or she has been instructed in such matters by an individual or individuals who have been trained and is thus thoroughly acquainted with the knowledge related to this work.</li> <li>• The qualified installer who is allowed to do the refrigerant handling and piping work involved in installation, relocation and removal has the qualifications pertaining to this refrigerant handling and piping work as stipulated by the local laws and regulations, and he or she is a person who has been trained in matters relating to refrigerant handling and piping work on the air conditioners made by Toshiba Carrier Corporation or, alternatively, he or she has been instructed in such matters by an individual or individuals who have been trained and is thus thoroughly acquainted with the knowledge related to this work.</li> <li>• The qualified installer who is allowed to work at heights has been trained in matters relating to working at heights with the air conditioners made by Toshiba Carrier Corporation or, alternatively, he or she has been instructed in such matters by an individual or individuals who have been trained and is thus thoroughly acquainted with the knowledge related to this work.</li> </ul>
Qualified service person	<ul style="list-style-type: none"> <li>• The qualified service person is a person who installs, repairs, maintains, relocates and removes the air conditioners made by Toshiba Carrier Corporation. He or she has been trained to install, repair, maintain, relocate and remove the air conditioners made by Toshiba Carrier Corporation or, alternatively, he or she has been instructed in such operations by an individual or individuals who have been trained and is thus thoroughly acquainted with the knowledge related to these operations.</li> <li>• The qualified service person who is allowed to do the electrical work involved in installation, repair, relocation and removal has the qualifications pertaining to this electrical work as stipulated by the local laws and regulations, and he or she is a person who has been trained in matters relating to electrical work on the air conditioners made by Toshiba Carrier Corporation or, alternatively, he or she has been instructed in such matters by an individual or individuals who have been trained and is thus thoroughly acquainted with the knowledge related to this work.</li> <li>• The qualified service person who is allowed to do the refrigerant handling and piping work involved in installation, repair, relocation and removal has the qualifications pertaining to this refrigerant handling and piping work as stipulated by the local laws and regulations, and he or she is a person who has been trained in matters relating to refrigerant handling and piping work on the air conditioners made by Toshiba Carrier Corporation or, alternatively, he or she has been instructed in such matters by an individual or individuals who have been trained and is thus thoroughly acquainted with the knowledge related to this work.</li> <li>• The qualified service person who is allowed to work at heights has been trained in matters relating to working at heights with the air conditioners made by Toshiba Carrier Corporation or, alternatively, he or she has been instructed in such matters by an individual or individuals who have been trained and is thus thoroughly acquainted with the knowledge related to this work.</li> </ul>

### Definition of Protective Gear



When the air conditioner is to be transported, installed, maintained, repaired or removed, wear protective gloves and 'safety' work clothing.

In addition to such normal protective gear, wear the protective gear described below when undertaking the special work detailed in the table below.

Failure to wear the proper protective gear is dangerous because you will be more susceptible to injury, burns, electric shocks and other injuries.

Work undertaken	Protective gear worn
All types of work	Protective gloves 'Safety' working clothing
Electrical-related work	Gloves to provide protection for electricians and from heat Insulating shoes Clothing to provide protection from electric shock
Work done at heights (50 cm or more)	Helmets for use in industry
Transportation of heavy objects	Shoes with additional protective toe cap
Repair of outdoor unit	Gloves to provide protection for electricians and from heat

These safety cautions describe important matters concerning safety to prevent injury to users or other people and damages to property. Please read through this manual after understanding the contents below (meanings of indications), and be sure to follow the description.





Indication	Meaning of Indication
 <b>WARNING</b>	Text set off in this manner indicates that failure to adhere to the directions in the warning could result in serious bodily harm (*1) or loss of life if the product is handled improperly.
 <b>CAUTION</b>	Text set off in this manner indicates that failure to adhere to the directions in the caution could result in slight injury (*2) or damage (*3) to property if the product is handled improperly.

\*1: Serious bodily harm indicates loss of eyesight, injury, burns, electric shock, bone fracture, poisoning, and other injuries which leave aftereffect and require hospitalization or long-term treatment as an outpatient.















\*2: Slight injury indicates injury, burns, electric shock, and other injuries which do not require hospitalization or long-term treatment as an outpatient.

\*3: Damage to property indicates damage extending to buildings, household effects, domestic livestock, and pets.

### MEANINGS OF SYMBOLS DISPLAYED ON THE UNIT

	<b>WARNING</b> (Risk of fire)	This mark is for R32 refrigerant only. In case that refrigerant type is R32, this unit uses a flammable refrigerant. If refrigerant leaks and comes in contact with fire or heating part, it will create harmful gas and there is risk of fire.
		Read the OWNER'S MANUAL carefully before operation.
		Service personnel are required to carefully read the OWNER'S MANUAL and INSTALLATION MANUAL before operation.
		Further information is available in the OWNER'S MANUAL, INSTALLATION MANUAL, and the like.

## ■ Warning indications on the air conditioner unit

Warning indication	Description		
<table border="1"> <tr> <td data-bbox="161 282 255 440"></td> <td data-bbox="255 282 510 440"> <p><b>WARNING</b></p> <p><b>ELECTRICAL SHOCK HAZARD</b> Disconnect all remote electric power supplies before servicing.</p> </td> </tr> </table>		<p><b>WARNING</b></p> <p><b>ELECTRICAL SHOCK HAZARD</b> Disconnect all remote electric power supplies before servicing.</p>	<p><b>WARNING</b></p> <p><b>ELECTRICAL SHOCK HAZARD</b> Disconnect all remote electric power supplies before servicing.</p>
	<p><b>WARNING</b></p> <p><b>ELECTRICAL SHOCK HAZARD</b> Disconnect all remote electric power supplies before servicing.</p>		
<table border="1"> <tr> <td data-bbox="161 504 255 662"></td> <td data-bbox="255 504 510 662"> <p><b>WARNING</b></p> <p>Moving parts. Do not operate unit with grille removed. Stop the unit before the servicing.</p> </td> </tr> </table>		<p><b>WARNING</b></p> <p>Moving parts. Do not operate unit with grille removed. Stop the unit before the servicing.</p>	<p><b>WARNING</b></p> <p>Moving parts. Do not operate unit with grille removed. Stop the unit before the servicing.</p>
	<p><b>WARNING</b></p> <p>Moving parts. Do not operate unit with grille removed. Stop the unit before the servicing.</p>		
<table border="1"> <tr> <td data-bbox="161 726 255 884"></td> <td data-bbox="255 726 510 884"> <p><b>CAUTION</b></p> <p>High temperature parts. You might get burned when removing this panel.</p> </td> </tr> </table>		<p><b>CAUTION</b></p> <p>High temperature parts. You might get burned when removing this panel.</p>	<p><b>CAUTION</b></p> <p>High temperature parts. You might get burned when removing this panel.</p>
	<p><b>CAUTION</b></p> <p>High temperature parts. You might get burned when removing this panel.</p>		
<table border="1"> <tr> <td data-bbox="161 948 255 1107"></td> <td data-bbox="255 948 510 1107"> <p><b>CAUTION</b></p> <p>Do not touch the aluminum fins of the unit. Doing so may result in injury.</p> </td> </tr> </table>		<p><b>CAUTION</b></p> <p>Do not touch the aluminum fins of the unit. Doing so may result in injury.</p>	<p><b>CAUTION</b></p> <p>Do not touch the aluminium fins of the unit. Doing so may result in injury.</p>
	<p><b>CAUTION</b></p> <p>Do not touch the aluminum fins of the unit. Doing so may result in injury.</p>		
<table border="1"> <tr> <td data-bbox="161 1170 255 1329"></td> <td data-bbox="255 1170 510 1329"> <p><b>CAUTION</b></p> <p><b>BURST HAZARD</b> Open the service valves before the operation, otherwise there might be the burst.</p> </td> </tr> </table>		<p><b>CAUTION</b></p> <p><b>BURST HAZARD</b> Open the service valves before the operation, otherwise there might be the burst.</p>	<p><b>CAUTION</b></p> <p><b>BURST HAZARD</b> Open the service valves before the operation, otherwise there might be the burst.</p>
	<p><b>CAUTION</b></p> <p><b>BURST HAZARD</b> Open the service valves before the operation, otherwise there might be the burst.</p>		

# 1 PRECAUTIONS FOR SAFETY

- Ensure that all Local, National and International regulations are satisfied.
- Read this “PRECAUTIONS FOR SAFETY” carefully before Installation.
- The precautions described below include the important items regarding safety. Observe them without fail.
- After the installation work, perform a trial operation (test run) to check for any problem.  
Follow the Owner’s Manual to explain how to use and maintain the unit to the customer.
- Turn off the main power supply switch (or breaker) before the unit maintenance.
- Ask the customer to keep the Installation Manual together with the Owner’s Manual.

---

The manufacturer shall not assume any liability for the damage caused by not observing the description of this manual.

## WARNING

### General

- Before starting to install the air conditioner, read through the Installation Manual carefully, and follow its instructions to install the air conditioner.
- Only a qualified installer(\*1) or qualified service person(\*1) is allowed to do installation work. Inappropriate installation may result in water leakage, electric shock or fire.
- Do not use any refrigerant different from the one specified for complement or replacement. Otherwise, abnormally high pressure may be generated in the refrigeration cycle, which may result in a failure or explosion of the product or an injury to your body.
- Before opening the front panel of the indoor unit or service panel of the outdoor unit, set the circuit breaker to the OFF position. Failure to set the circuit breaker to the OFF position may result in electric shocks through contact with the interior parts. Only a qualified installer(\*1) or qualified service person(\*1) is allowed to remove the front panel of the indoor unit or service panel of the outdoor unit and do the work required.
- Before carrying out the installation, maintenance, repair or removal work, be sure to set the circuit breaker to the OFF position. Otherwise, electric shocks may result.
- Place a “Work in progress” sign near the circuit breaker while the installation, maintenance, repair or removal work is being carried out. There is a danger of electric shocks if the circuit breaker is set to ON by mistake.

- Only a qualified installer(\*1) or qualified service person(\*1) is allowed to undertake work at heights using a stand of 50 cm or more or to remove the front panel of the indoor unit to undertake work.
- Wear protective gloves and safety work clothing during installation, servicing and removal.
- Do not touch the aluminium fin of the unit. You may injure yourself if you do so. If the fin must be touched for some reason, first put on protective gloves and safety work clothing, and then proceed.
- Do not climb onto or place objects on top of the outdoor unit. You may fall or the objects may fall off of the outdoor unit and result in injury.
- When work is performed at heights, use a ladder which complies with the ISO 14122 standard, and follow the procedure in the ladder's instructions. Also wear a helmet for use in industry as protective gear to undertake the work.
- Before cleaning the filter or other parts of the outdoor unit, set the circuit breaker to OFF without fail, and place a "Work in progress" sign near the circuit breaker before proceeding with the work.
- Before working at heights, put a sign in place so that no-one will approach the work location, before proceeding with the work. Parts and other objects may fall from above, possibly injuring a person below. While carrying out the work, wear a helmet for protection from falling objects.
- Do not use the refrigerant other than R32.  
For the refrigerant type, check the outdoor unit to be combined.
- The refrigerant used by this air conditioner, follow to the outdoor unit.
- The air conditioner must be transported in stable condition. If any part of the product is broken, contact the dealer.
- When the air conditioner must be transported by hand, carry it by two or more people.
- Do not move or repair any unit by yourself. There is high voltage inside the unit. You may get electric shock while removing the cover and main unit.
- This appliance is intended to be used by expert or trained users in shops, in light industry, or for commercial use by lay persons.

## Selection of installation location

- When the air conditioner is installed in a small room, provide appropriate measures to ensure that the concentration of refrigerant leakage occur in the room does not exceed the critical level.
- Do not install the air conditioner in a location that may be subject to a risk of exposure to a combustible gas. If a combustible gas leaks and becomes concentrated around the unit, a fire may occur.
- To transport the air conditioner, wear shoes with additional protective toe caps.
- To transport the air conditioner, do not take hold of the bands around the packing carton. You may injure yourself if the bands should break.
- Do not place any combustion appliance in a place where it is directly exposed to the wind of air conditioner, otherwise it may cause imperfect combustion.
- Do not install in a location where flammable gas leaks are possible. If the gas leak and accumulate around the unit, it may ignite and cause a fire.
- Install the indoor unit at least 2.5 m above the floor level since otherwise the users may injure themselves or receive electric shocks if they poke their fingers or other objects into the indoor unit while the air conditioner is running.

## Installation

- Install the air conditioner securely in a location where the base can sustain the weight adequately. If the strength is not enough, the unit may fall down resulting in injury.
- Follow the instructions in the Installation Manual to install the air conditioner. Failure to follow these instructions may cause the product to fall down or topple over or give rise to noise, vibration, water leakage or other trouble.
- Carry out the specied installation work to guard against the possibility of high winds and earthquake. If the air conditioner is not installed appropriately, a unit may topple over or fall down, causing an accident.
- If refrigerant gas has leaked during the installation work, ventilate the room immediately. If the leaked refrigerant gas comes in contact with fire, noxious gas may generate.
- Use forklift to carry in the air conditioner units and use winch or hoist at installation of them.



## Refrigerant piping

- Install the refrigerant pipe securely during the installation work before operating the air conditioner. If the compressor is operated with the valve open and without refrigerant pipe, the compressor sucks air and the refrigeration cycles is over pressurized, which may cause a injury.
- Tighten the flare nut with a torque wrench in the specified manner. Excessive tighten of the flare nut may cause a crack in the flare nut after a long period, which may result in refrigerant leakage.
- After the installation work, confirm that refrigerant gas does not leak. If refrigerant gas leaks into the room and flows near a fire source, such as a cooking range, noxious gas may be generated.
- When the air conditioner has been installed or relocated, follow the instructions in the Installation Manual and purge the air completely so that no gases other than the refrigerant will be mixed in the refrigerating cycle. Failure to purge the air completely may cause the air conditioner to malfunction.
- Nitrogen gas must be used for the airtight test.
- The charge hose must be connected in such a way that it is not slack.

## Electrical wiring

- Only a qualified installer(\*1) or qualified service person(\*1) is allowed to carry out the electrical work of the air conditioner. Under no circumstances must this work be done by an unqualified individual since failure to carry out the work properly may result in electric shocks and/or electrical leaks.
- To connect the electrical wires, repair the electrical parts or undertake other electrical jobs, wear gloves to provide protection for electricians and from heat, insulating shoes and clothing to provide protection from electric shocks. Failure to wear this protective gear may result in electric shocks.
- Use wiring that meets the specifications in the Installation Manual and the stipulations in the local regulations and laws. Use of wiring which does not meet the specifications may give rise to electric shocks, electrical leakage, smoking and/or a fire.
- Connect earth wire. (grounding work)  
Incomplete grounding causes an electric shock.
- Do not connect earth wires to gas pipes, water pipes, and lightning conductor or telephone earth wires.
- After completing the repair or relocation work, check that the earth wires are connected properly.
- Install a circuit breaker that meets the specifications in the installation manual and the stipulations in the local regulations and laws.
- Install the circuit breaker where it can be easily accessed by the agent.
- When installing the circuit breaker outdoors, install one which is designed to be used outdoors.

- Under no circumstances the power wire must not be extended. Connection trouble in the places where the wire is extended may give rise to smoking and/or a fire.
- Electrical wiring work shall be conducted according to law and regulation in the community and installation manual. Failure to do so may result in electrocution or short circuit.

### **Test run**

- Before operating the air conditioner after having completed the work, check that the electrical control box cover of the indoor unit and service panel of the outdoor unit are closed, and set the circuit breaker to the ON position. You may receive an electric shock if the power is turned on without first conducting these checks.
- If there is any kind of trouble (such as an error display has appeared, smell of burning, abnormal sounds, the air conditioner fails to cool or heat or water is leaking) has occurred in the air conditioner, do not touch the air conditioner yourself but set the circuit breaker to the OFF position, and contact a qualified service person. Take steps to ensure that the power will not be turned on (by marking “out of service” near the circuit breaker, for instance) until qualified service person(\*1) arrives. Continuing to use the air conditioner in the trouble status may cause mechanical problems to escalate or result in electric shocks or other trouble.
- After the work has finished, use an insulation tester set (500V Megger) to check the resistance is 1 MΩ or more between the charge section and the non-charge metal section (earth section). If the resistance value is low, a disaster such as a leak or electric shock is caused at user’s side.
- Upon completion of the installation work, check for refrigerant leaks and check the insulation resistance and water drainage. Then conduct a test run to check that the air conditioner is operating properly.

### **Explanations given to user**

- Upon completion of the installation work, tell the user where the circuit breaker is located. If the user does not know where the circuit breaker is, he or she will not be able to turn it off in the event that trouble has occurred in the air conditioner.
- If the fan grille is damaged, do not approach the outdoor unit but set the circuit breaker to the OFF position, and contact a qualified service person(\*1) to have the repairs done. Do not set the circuit breaker to the ON position until the repairs are completed.
- After the installation work, follow the Owner’s Manual to explain to the customer how to use and maintain the unit.

---

## Relocation

- Only a qualified installer(\*1) or qualified service person(\*1) is allowed to relocate the air conditioner. It is dangerous for the air conditioner to be relocated by an unqualified individual since a fire, electric shocks, injury, water leakage, noise and/or vibration may result.
  - While carrying out the pump-down work shut down the compressor before disconnecting the refrigerant pipe. Disconnecting the refrigerant pipe with the service valve left open and the compressor still operating will cause air or other gas to be sucked in, raising the pressure inside the refrigeration cycle to an abnormally high level, and possibly resulting in rupture, injury or other trouble.
- 

## CAUTION

---

### **This Air Conditioner has adopted a refrigerant HFC (R32) which does not destroy the ozone layer.**

- As the R32 refrigerant is easily affected by impurities such as moisture, oxidized film, oil, etc., due to the high pressure, be careful not to allow the moisture, dirt, existing refrigerant, refrigerating machine oil, etc., to get mixed up in the refrigeration cycle during the installation work.
- A special tool for the R32 refrigerant is required for installation.
- Use a new and clean piping materials for the connecting pipe so that moisture and dirt are not mixed together during the installation work.
- When using existing pipes, follow the installation manual enclosed with the outdoor unit.

### **To disconnect the appliance from main power supply.**

- This appliance must be connected to the main power supply by means of a switch with a contact separation of at least 3 mm.









### **The installation fuse (all types can be used) must be used for the power supply line of this air conditioner.**

**Install the indoor unit at least 2.5 m above the floor level since otherwise the users may injure themselves or receive electric shocks if they poke their fingers or other objects into the indoor unit while the air conditioner is running.**

---

(\*1) Refer to the “Definition of Qualified Installer or Qualified Service Person.”

## 2 ACCESSORY PARTS

Part name	Q'ty	Shape	Usage
Installation Manual	1	This manual	(Hand over to customers) (For other languages that do not appear in this installation Manual, please refer to the enclosed CD-R.)
Owner's Manual	1		(Hand over to customers) (For other languages that do not appear in this Owner's Manual, please refer to the enclosed CD-R.)
CD-ROM	1	-	Owner's Manual and Installation Manual.
Installation plate	1		
Wireless remote controller	1		
Battery	2		
Remote controller holder	1		
Mounting screw $\varnothing 4 \times 25 \ell$	6		
Flat head wood screw $\varnothing 3.1 \times 16 \ell$	2		
Screw $\varnothing 4 \times 10 \ell$	2		
Heat insulator	1		

### 3 SELECTION OF INSTALLATION PLACE

#### WARNING

- **Install the air conditioner at enough strong place to withstand the weight of the unit.**  
If the strength is not enough, the unit may fall down resulting in injury.

#### CAUTION

- **Do not install the air conditioner in a location subject to a risk of exposure to a combustible gas.**  
If a combustible gas leaks and stays around the unit, a fire may occur.

**Upon approval of the customer, install the air conditioner in a place that satisfies the following conditions.**

- Place where the unit can be installed horizontally.
- Place where a sufficient servicing space can be ensured for safety maintenance and check.
- Place where drained water will not cause any problem.

#### **Avoid installing in the following places.**

Select a location for the indoor unit where the cool or warm air will circulate evenly.

Avoid installation in the following kinds of locations.

- Saline area (coastal area).
- Locations with acidic or alkaline atmospheres (such as areas with hot springs, factories where chemicals or pharmaceuticals are made and places where the exhaust air from combustion appliances will be sucked into the unit).  
Doing so may cause the heat exchanger (its aluminum fins and copper pipes) and other parts to become corroded.
- Locations with atmospheres with mist of cutting oil or other types of machine oil.  
Doing so may cause the heat exchanger to become corroded, mists caused by the blockage of the heat exchanger to be generated, the plastic parts to be damaged, the heat insulators to peel off, and other such problems to result.
- Places where iron or other metal dust is present. If iron or other metal dust adheres to or collects on the interior of the air conditioner, it may spontaneously combust and start a fire.
- Locations where vapors from food oils are formed (such as kitchens where food oils are used).  
Blocked filters may cause the air conditioner's performance to deteriorate, condensation to form, the plastic parts to be damaged, and other such problems to result.
- Locations near obstructions such as ventilation openings or lighting fixtures where the flow of the blown air will be disrupted (a disruption of the air flow may cause the air conditioner's performance to deteriorate or the unit to shut down).
- Locations where an in-house power generator is used for the power supply.  
The power line frequency and voltage may fluctuate, and the air conditioner may not work properly as a result.
- On truck cranes, ships or other moving conveyances.
- The air conditioner must not be used for special applications (such as for storing food, plants, precision instruments or art works).  
(The quality of the items stored may be degraded.)
- Locations where high frequencies are generated (by inverter equipment, in-house power generators, medical equipment or communication equipment).  
(Malfunctioning or control trouble in the air conditioner or noise may adversely affect the equipment's operation.)
- Locations where there is anything under the unit installed that would be compromised by wetness.  
(If the drain has become blocked or when the humidity is over 80%, condensation from the indoor unit will drip, possibly causing damage to anything underneath.)
- In the case of the wireless type of system, rooms with the inverter type of fluorescent lighting or locations exposed to direct sunlight.  
(The signals from the wireless remote controller may not be sensed.)
- Locations where organic solvents are being used.
- The air conditioner cannot be used for liqueed carbonic acid cooling or in chemical plants.
- Location near doors or windows where the air conditioner may come into contact with high-temperature, high-humidity outdoor air.  
(Condensation may occur as a result.)
- Locations where special sprays are used frequently.

## ■ Installation diagram of Indoor unit

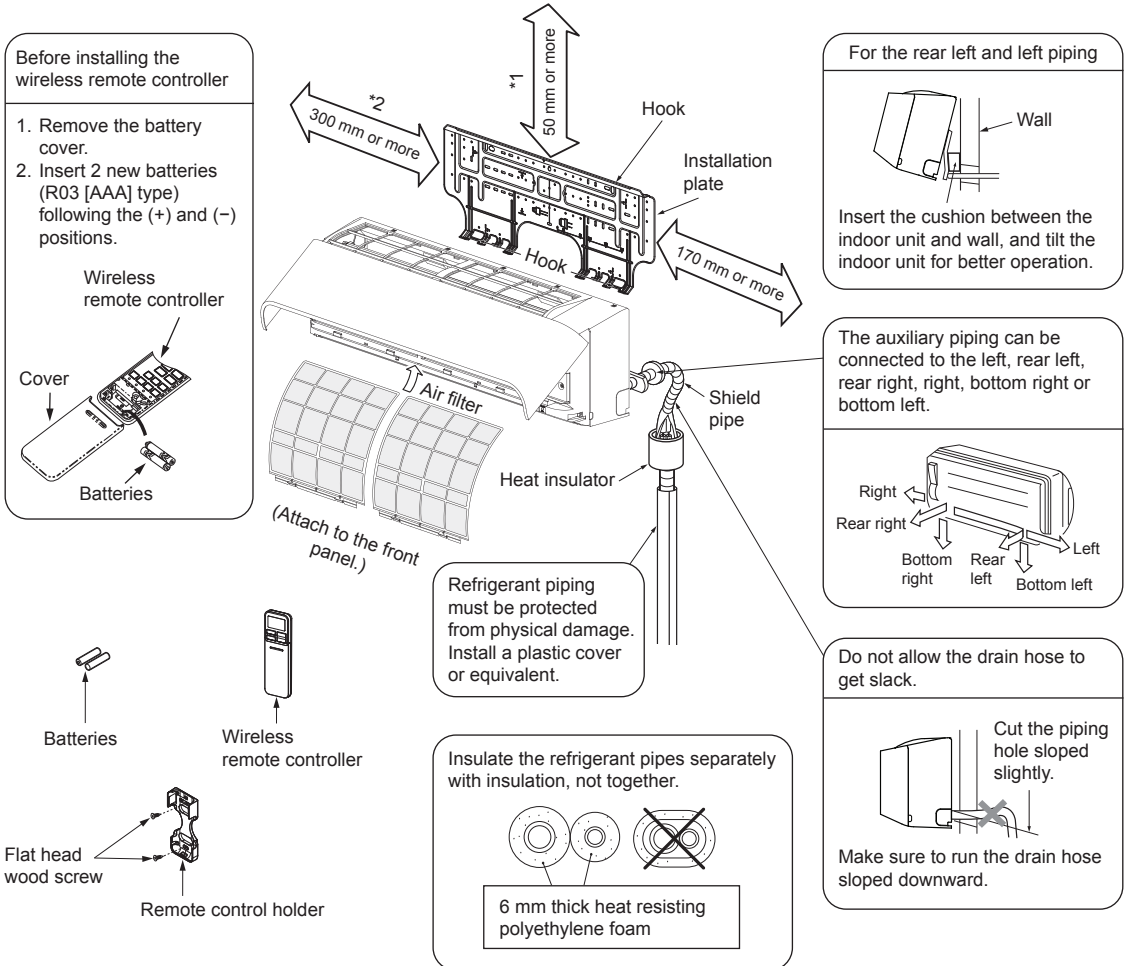

## ■ Installation space

The indoor unit shall be installed at least 2.5 m height.

Also it must be avoided to put anything on top of the indoor unit.

\*1 Reserve space required to install the indoor unit and for service work.

**Keep 50 mm or more for clearance between top plate of the indoor unit and the ceiling surface.**

\*2 Provide a space as shown for service clearance for the cross flow fan.

## ■ Installation place

- A place which provides the spaces around the indoor unit as shown in the above diagram.
- A place where there is no obstacle near the air inlet and outlet.
- A place that allows easy installation of the piping to the outdoor unit.
- A place which allows the front panel to be opened.

### ⚠ CAUTION

- Direct sunlight to the indoor unit's wireless receiver should be avoided.
- The microprocessor in the indoor unit should not be too close to RF noise sources.  
(For details, see the owner's manual.)

## ■ Wireless remote controller

- A place where there are no obstacles such as a curtain that may block the signal from the indoor unit.
- Do not install the remote controller in a place exposed to direct sunlight or close to a heating source, such as a stove.
- Keep the remote controller at least 1 m apart from the nearest TV set or stereo equipment.  
(This is necessary to prevent image disturb-bounces or noise interference.)
- The location of the remote controller should be determined as shown below.

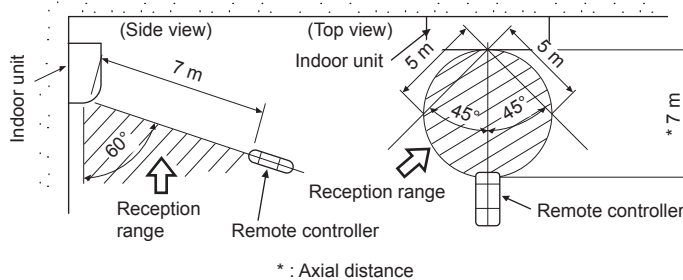

## 4 INSTALLATION OF INDOOR UNIT

### WARNING

Install the air conditioner certainly to sufficiently withstand the weight.  
If the strength is insufficient, the unit may fall down resulting in human injury.  
Perform a specified installation work to guard against strong wind or earthquake.  
An incomplete installation can cause accidents by the units falling and dropping.

### REQUIREMENT

- Strictly comply with the following rules to prevent damage of the indoor units and human injury.
- Do not put a heavy article on the indoor unit. (Even units are packaged)
  - Carry in the indoor unit as it is packaged if possible. If carrying in the indoor unit unpacked by necessity, be sure to use buffering cloth, etc. to not damage the unit.
  - To move the indoor unit, do not apply force to the refrigerant pipe, drain pan, foamed parts, or resin parts, etc.
  - Carry the package by two or more persons, and do not bundle it with plastic band at positions other than specified.

Be careful to the following items when installing the unit.

- Considering air discharge direction, select an installation place where discharge air can circulate evenly in a room. Avoid to install the unit at place with “NO GOOD” mark in the right figure.

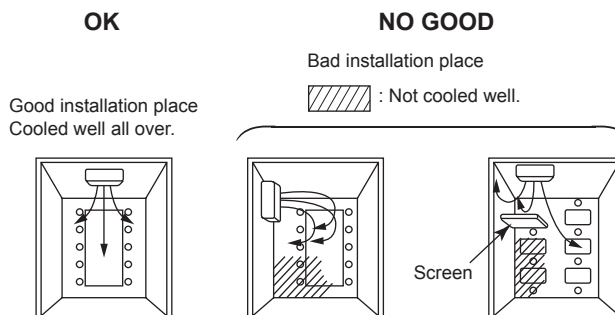

# 5 CUTTING A HOLE AND MOUNTING INSTALLATION PLATE

## ■ Cutting a hole

In case of installing the refrigerant pipes from the rear:

- 1 Decide the hole position for piping at 180 mm from the arrow mark (⇒) on the installation plate and drill a hole at a slight downward slant toward outdoor side.

Pipe hole; dia.80 mm: GM90 type

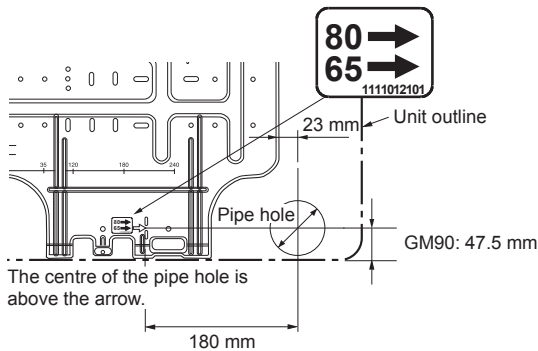

### NOTE

- When drilling a wall that contains a metal lath, wire lath or metal plate, be sure to use a pipe hole brim ring sold separately.

## ■ Mounting the installation plate

Be sure that the installation plate is fix to the wall with screws to make the indoor unit fit to the wall.

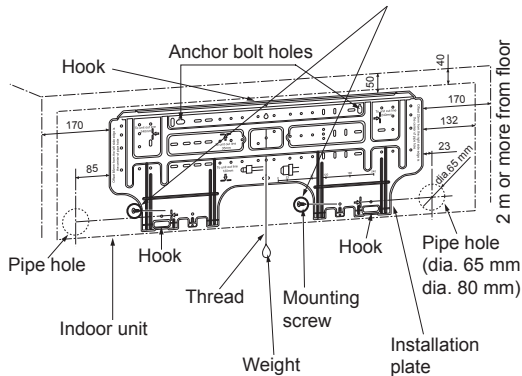

## ■ When the installation plate is directly mounted on the wall

1. Securely fit the installation plate onto the wall by screwing it in the upper and lower parts to hook up the indoor unit.
2. To mount the installation plate on a concrete wall with anchor bolts, utilize the anchor bolt holes as illustrated in the above figure.
3. Install the installation plate horizontally in the wall.

### ⚠ CAUTION

When installing the installation plate with a mounting screw, do not use the anchor bolt hole. Otherwise the unit may fall down and result in personal injury and property damage.

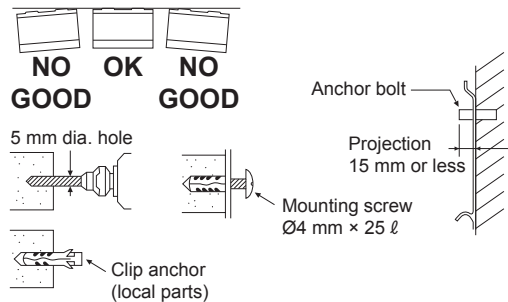

### ⚠ CAUTION

Failure to firmly install the unit may result in personal injury and property damage if the unit falls.

- In case of block, brick, concrete or similar type walls, make 5 mm dia. holes in the wall.
- Insert clip anchors for appropriate mounting screws.

### NOTE

- Secure four corners and lower parts of the installation plate with 6 mounting screws to install it.



# 6 PIPING AND DRAIN HOSE INSTALLATION

## ■ Piping and drain hose forming

\* Since dewing results in a machine trouble, make sure to insulate both connecting pipes. (Use polyethylene foam as insulating material.)

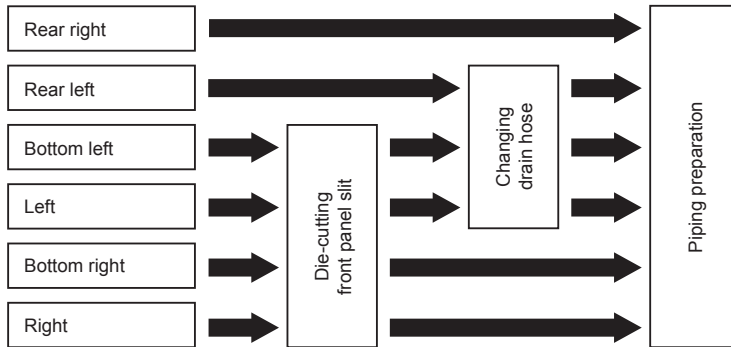

### 1. Die-cutting front panel slit

Cut out the slit on the left or right side of the front panel for the left or right connection and the slit on the bottom left or right side of the front panel for the bottom left or right connection with a pair of nippers.

### 2. Changing drain hose

For leftward connection, bottom-leftward connection and rear-leftward connection's piping, it is necessary to change the drain hose and drain cap.

#### How to remove the drain hose

- The drain hose can be removed by removing the screw securing the drain hose and then pulling out the drain hose.
- When removing the drain hose, be careful of any sharp edges of steel plate. The edges can injure.
- To install the drain hose, insert the drain hose firmly until the connection part contacts with heat insulator, and then secure it with original screw.

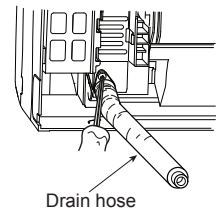

## How to remove the drains cap

Clip the drain cap by needle-nose pliers and pull out.

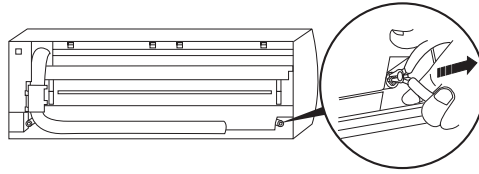

## How to fix the drains cap

1) Insert hexagonal wrench (dia. 4 mm) in a centre head.

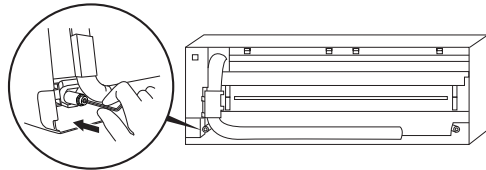

2) Firmly insert drains cap.

Do not apply lubricating oil (refrigerant machine oil) when inserting the drain cap. Application causes deterioration and drain leakage from the plug.

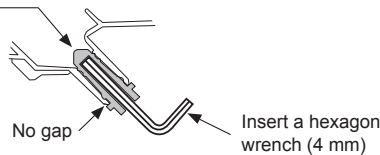

## ⚠ CAUTION

Firmly insert the drain hose and drain cap; otherwise, water may leak.

## How to remove the drain hose

- 1) Remove the front panel.
- 2) Remove the screws of drain hose.
- 3) Pull out the drain hose.

### ▼ In case of right or left piping

- After scribing slits of the front panel with a knife or a marking-off pin, cut them with a pair of nippers or an equivalent tool.

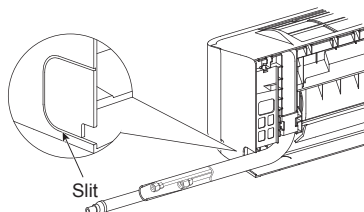

## How to fix the drain hose

- 1) Put the drain hose.
- 2) Screw the drain hose to the indoor unit.
- 3) Install the front panel.

### ▼ In case of bottom right or bottom left piping

- After scribing slits of the front panel with a knife or a marking-off pin, cut them with a pair of nippers or an equivalent tool.

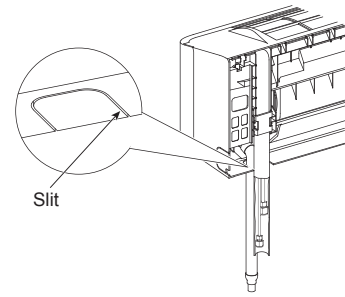

### ▼ Left-hand connection with piping

Bend the connecting pipe so that it is laid within 43 mm above the wall surface. If the connecting pipe is laid exceeding 43 mm above the wall surface, the indoor unit may unstably be set on the wall. When bending the connecting pipe, make sure to use a spring bender so as not to crush the pipe.

#### **Bend the connecting pipe within a radius of 30 mm.**

To connect the pipe after installation of the unit (figure)

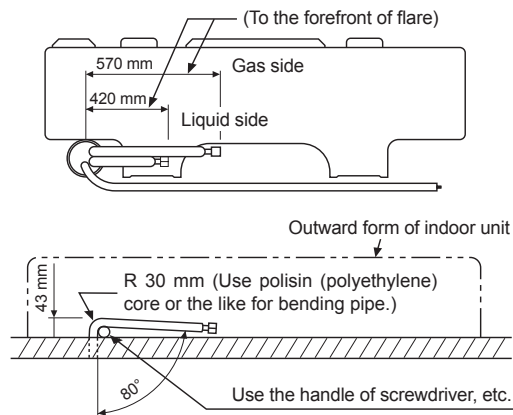

### NOTE

If the pipe is bent incorrectly, the indoor unit may unstably be set on the wall. After passing the connecting pipe through the pipe hole, connect the connecting pipe to the auxiliary pipes and wrap the facing tape around them.

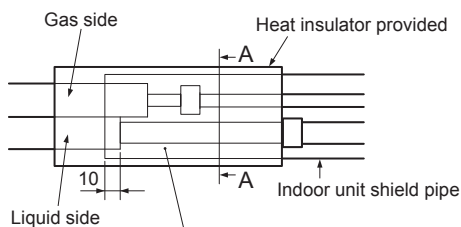

Cut the heat insulator of the gas pipe (locally procured) leaving a 10 mm overlap with the shield of the shield pipe.



### Heat insulator wrapping cross section A-A

Make the slit part of heat insulator to upward.

#### ▼ Insulating the pipes

Insulate the indoor unit completely so there are no gaps using the heat insulator provided.

### ⚠ CAUTION

Securely apply insulation all the way up to the pipe connecting section of the indoor unit so that there is no exposed area. (the pipe exposed to the outside causes water leak.)  
When wrapping the heat insulator around pipes, make sure the slit aperture toward the ceiling surface.

### ⚠ CAUTION

- Bind the auxiliary pipes (two) and power supply wiring and control wiring with facing tape tightly. In case of leftward piping and rear-leftward piping, bind the auxiliary pipes (two) only with facing tape.

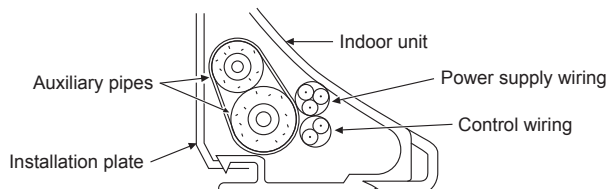

- Carefully arrange pipes so that any pipe does not stick out of the rear plate of the indoor unit.
- Carefully connect the auxiliary pipes and connecting pipes to one another and cut off the insulating tape wound on the connecting pipe to avoid double-taping at the joint; moreover, seal the joint with the vinyl tape, etc.
- Since dew results in a machine trouble, make sure to insulate both the connecting pipes. (Use polyethylene foam as insulating material.)
- When bending a pipe, carefully do it, not to crush it.

## 7 INDOOR UNIT FIXING

1. Pass the pipe through the hole in the wall, and hook the indoor unit on the installation plate at the upper hooks.
2. Swing the indoor unit to right and left to confirm that it is firmly hooked up on the installation plate.
3. While pressing the indoor unit onto the wall, hook it at the lower part on the installation plate. Pull the indoor unit toward you to confirm that it is firmly hooked up on the installation plate.

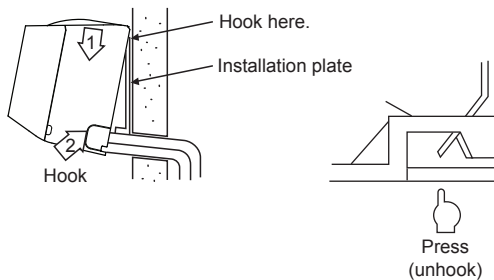

- For detaching the indoor unit from the installation plate, pull the indoor unit toward you while pushing its bottom up at the specified parts.

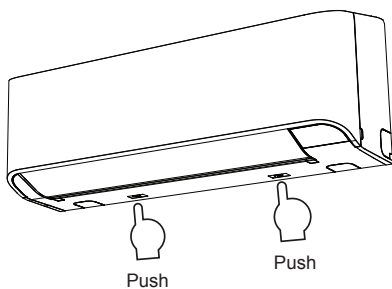

### REQUIREMENT

The lower part of indoor unit may float, due to the condition of piping and you cannot fix it to the installation plate. In that case, use the screws provided to fix the unit and the installation plate.

**Especially when the pipes are pulled out from the left side, the unit must be screwed to the installation plate.**

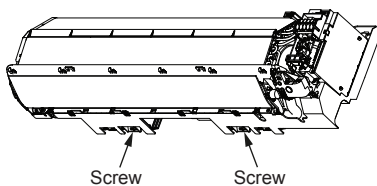

## 8 DRAINAGE

1. Run the drain hose sloped downwards.

### NOTE

- Hole should be made at a slight downward slant on the outdoor side.
2. Put water in the drain pan and make sure that the water is drained out of doors.
  3. When connecting extension drain hose, insulate the connecting part of extension drain hose with shield pipe.

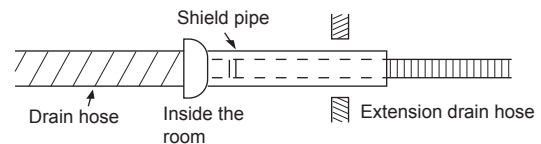
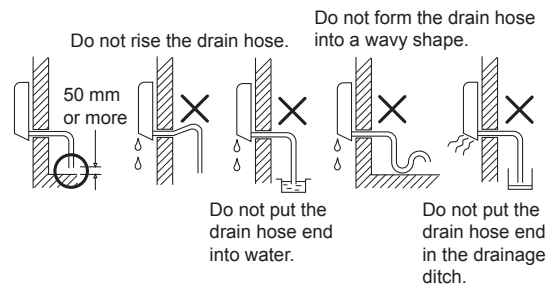

### CAUTION

Arrange the drain pipe for proper drainage from the unit.  
Improper drainage can result in dew-dropping.

This air conditioner has the structure designed to drain water collected from dew, which forms on the back of the indoor unit, to the drain pan. Therefore, do not store the power cord and other parts at a height above the drain guide.

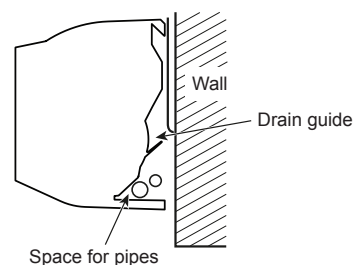

# 9 REFRIGERANT PIPING

## ■ Refrigerant Piping

1. Use copper pipe with 0.8 mm or more thickness. (In case pipe size is dia. 15.9, with 1.0 mm or more.)
2. Flare nut and flare works are also different from those of the conventional refrigerant. Take out the flare nut attached to the main unit of the air conditioner, and use it.

### REQUIREMENT

When the refrigerant pipe is long, provide support brackets at intervals of 2.5 to 3 m to clamp the refrigerant pipe. Otherwise, abnormal sound may be generated.

### ⚠ CAUTION

#### IMPORTANT 4 POINTS FOR PIPING WORK

1. Reusable mechanical connectors and flared joints are not allowed indoors. When mechanical connectors are reused indoors, sealing parts shall be renewed. When flared joints are reused indoors, the flare part shall be refabricated.
2. Tight connection (between pipes and unit)
3. Evacuate the air in the connecting pipes by using VACUUM PUMP.
4. Check the gas leakage. (Connected points)

## ■ Pipe size

(dia. : mm)

RAV	PIPE SIZE (mm)	
	Gas side	Liquid side
HM56	12.7	6.4
HM80, 90	15.9	9.5

## ■ Permissible Piping Length and Height Difference

They vary according to the outdoor unit. For details, refer to the Installation Manual attached to the outdoor unit.

### Flaring

- Cut the pipe with a pipe cutter. Remove burrs completely. Remaining burrs may cause gas leakage.
- Insert a flare nut into the pipe, and flare the pipe.

As the flaring sizes of R32 differ from those of refrigerant R22, the flare tools newly manufactured for R32 are recommended.

However, the conventional tools can be used by adjusting projection margin of the copper pipe.

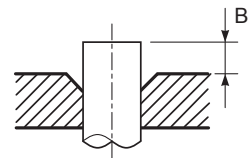

#### ▼ Projection margin in flaring: B (Unit: mm)

RIDGID (Clutch type)

Outer dia. of copper pipe	Tool used	Conventional tool used
6.4 , 9.5	0.5 to 1.0	1.0 to 1.5
12.7 , 15.9	0.5 to 1.1	1.5 to 2.0

#### ▼ Flaring dia. meter size: A (Unit: mm)

Outer dia. of copper pipe	A $\frac{3}{4}$
6.4	9.1
9.5	13.2
12.7	16.6
15.9	19.7

**CAUTION**

- Do not scratch the inner surface of the flared part when removing burrs.
- Flare processing under the condition of scratches on the inner surface of flare processing part will cause refrigerant gas leak.
- Check that the flared part is not scratched, deformed, stepped, or flattened, and that there are no chips adhered or other problems, after flare processing.
- Do not apply refrigerating machine oil to the flare surface.

\* In case of flaring with the conventional flare tool, pull it out approx. 0.5 mm more than that for R22 to adjust to the specified flare size. The copper pipe gauge is useful for adjusting projection margin size.

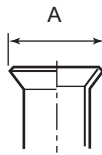

**Tightening connection**

**CAUTION**

- Do not apply excessive torque. Otherwise, the nut may crack depending on the conditions.

(Unit: N•m)

Outer dia. of copper pipe	Tightening torque
6.4 mm (dia.)	14 to 18 (1.4 to 1.8 kgf•m)
9.5 mm (dia.)	33 to 42 (3.3 to 4.2 kgf•m)
12.7 mm (dia.)	50 to 62 (5.0 to 6.2 kgf•m)
15.9 mm (dia.)	68 to 82 (6.8 to 8.2 kgf•m)

**▼ Tightening torque of flare pipe connections**

Incorrect connections may cause not only a gas leak, but also a trouble of the refrigeration cycle. Align the centres of the connecting pipes and tighten the flare nut as far as possible with your fingers. Then tighten the nut with a spanner and torque wrench as shown in the figure.

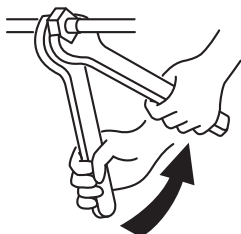

Work using double spanner

**REQUIREMENT**

Tightening with an excessive torque may crack the nut depending on installation conditions. Tighten the nut within the specified tightening torque.

**Piping with outdoor unit**

- Shape of valve differs according to the outdoor unit.  
For details of installation, refer to the Installation Manual of the outdoor unit.

**Heat insulation**

Heat insulation for the pipes should be done separately for the liquid side and gas side. Because both of the liquid and gas side pipes become a low temperature during cooling operation, sufficient heat insulation should be done to prevent condensation.

- Heat insulator with a heat resistance of 120°C or more must be used for the gas side pipe.
- The pipe connection section of the indoor unit must be heat insulated securely and compactly with the attached heat insulator.

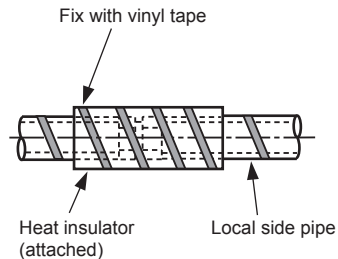

**REQUIREMENT**

Apply the heat insulation to the pipe connecting section of the indoor unit securely up to the root without exposure of the pipe. (the pipe exposed to the outside causes water leak.)

**■ Airtight test/Air purge, etc.**

For airtight test, air purge, addition of refrigerant, and gas leak check, follow the Installation Manual attached to the outdoor unit.

## ■ Open fully valves of the outdoor unit

Open the valve of the outdoor unit fully. A hexagonal wrench is required for opening the valve.

For details, refer to the Installation Manual attached to the outdoor unit.

## ■ Gas leak check

Check with a leak detector or soap water whether gas leaks or not, from the pipe connecting section or cap of the valve.



### REQUIREMENT

Use a leak detector manufactured exclusively HFC refrigerant (R410A, R134a, R32, etc.).

## ■ Wireless remote controller A-B selection

Using 2 wireless remote controllers for the respective air conditioners, when the 2 air conditioners are closely installed.

### Wireless remote controller B setup

- 1 Push **TEMPORARY**  button on the indoor unit to turn the air conditioner ON.
- 2 Point the wireless remote controller at the indoor unit.
- 3 Push and hold **CHK**  button on the wireless remote controller by the tip of the pencil. "00" will be shown on the display.
- 4 Push **MODE** during pushing **CHK** . "B" will be shown on the display and "00" will be disappear and the air conditioner will turn OFF. The wireless remote controller B is memorized.

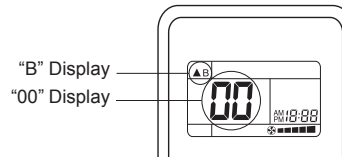

### NOTE

- Repeat above step to reset wireless remote controller to be A.
- The wireless remote controllers do not display "A".
- The factory default of the wireless remote controllers is "A".



# 10 ELECTRICAL CONNECTION

## WARNING

- **Use the specified wires for wiring connect the terminals. Securely fix them to prevent external forces applied to the terminals from affecting the terminals.**  
Incomplete connection or fixation may cause a fire or other trouble.
- **Connect earth wire. (grounding work)**  
Incomplete grounding cause an electric shock.  
Do not connect earth wires to gas pipes, water pipes, lightning conductor or telephone earth wires.
- **Appliance shall be installed in accordance with national wiring regulations.**  
Capacity shortage of power circuit or incomplete installation may cause an electric shock or a fire.
- **Under no circumstances, the power supply wire or the indoor and outdoor connecting wire must not be connected in the middle (Connection using a solderless terminal etc.)**  
Connection trouble in the places where the wire is connected in the middle may give rise to smoking and/or a fire.

## CAUTION

- For power supply specifications, follow the Installation Manual of outdoor unit.
  - Do not connect 220 – 240V power to the terminal blocks ( **A** , **B** ) for control wiring.  
Otherwise, the system will fail.
  - Do not damage or scratch the conductive core and inner insulator of power and Indoor / Outdoor connecting wires while peeling them.
  - Perform the electric wiring so that it does not come to contact with the high-temperature part of the pipe.  
The coating may melt resulting in an accident.
- 
- Do not turn on the power of the indoor unit until vacuuming of the refrigerant pipes completes.

## ■ Wiring specifications

### Indoor / Outdoor connecting wires specifications

#### Indoor unit power supplied from outdoor unit

- The outdoor unit power supply patterns vary on models.

Indoor unit power supply	1~50 Hz 220 - 240V 1~60 Hz 220V	
Indoor / Outdoor connecting wires*	4 × 1.5 mm <sup>2</sup> or more (H07RN-F or 60245 IEC 66)*	Up to 70 m

\*Number of wire × wire size

\*Including earth line

### Remote controller wiring

Remote controller wiring, remote controller inter-unit wiring	Wire size: 2 × 0.5 to 2.0 mm <sup>2</sup>	
Total wire length of remote controller wiring and remote controller inter-unit wiring = L + L1 + L2 + ... Ln	In case of wired type only	Up to 500 m
	2 remote controllers	Up to 300 m
	In case of wireless type included	Up to 400 m
Total wire length of remote controller inter-unit wiring = L1 + L2 + ... Ln		Up to 200 m

\* The remote controller wiring length differs depending on the remote controller used. For details, refer to the Installation Manual attached to the remote controller.

## ⚠ CAUTION

The remote controller wire and Indoor / Outdoor connecting wires cannot be parallel to contact each other and cannot be stored in the same conduits. If doing so, a trouble may be caused on the control system due to noise or other factor.

### ■ Communication type

TU2C-Link can be used with these models.

If the indoor unit and the connected remote controller / remote sensor are all TU2C-Link models, TU2C-Link communication will be performed automatically.

(If the TCC-Link model is included, TCC-Link communication will be performed.)

For details of communication type, refer to the following table.

#### Communication type and model names

Communication type	TU2C-Link	TCC-Link
Indoor unit	RAV-HM *** series model	Other than RAV-HM *** series
Wired remote controller	RBC-A **U *** ↑ This letter indicates U series model.	Other than U series
Wireless remote controller kit & receiver unit	RBC-AXU *** ↑ This letter indicates U series model.	Other than U series
Remote sensor	TCB-TC **U *** ↑ This letter indicates U series model.	Other than U series

## ⚠ CAUTION

When connecting to the central control device dedicated to TCC-Link, it is necessary to change to TCC-Link using a wired remote controller. Set according to the Communication type procedure of “11 Applicable controls”.

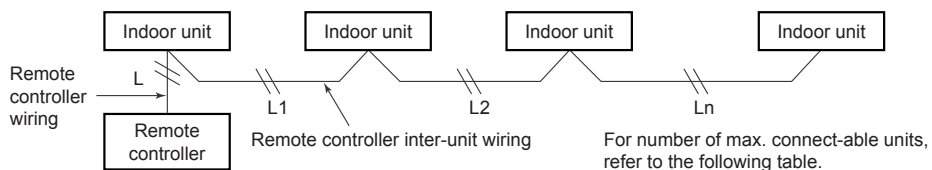

#### Max. number of connect-able indoor units, and communication type

	Unit type			
	Indoor unit	RAV-HM ***	RAV-HM ****	*
Remote controller	U series	*	U series	*
Remote sensor				
Communication type	TU2C-Link	TCC-Link		
Max. number of connect-able units	16	8		

\* : Other than RAV-HM \*\*\*\* and U series

## ■ Wiring between indoor unit and outdoor unit

- 1 Figure below shows the wiring connections between the indoor and outdoor units and between the indoor units and remote controller. The wires indicated by the broken lines or dot-and-dash lines are provided at the locally.
- 2 Refer to the both indoor and outdoor unit wiring diagrams.
- 3 The power of the indoor unit is supplied from the outdoor unit.

### Wiring diagram

#### ▼ Single system

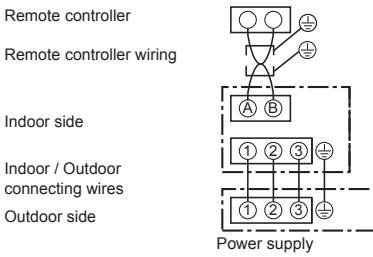

#### ▼ Simultaneous twin system

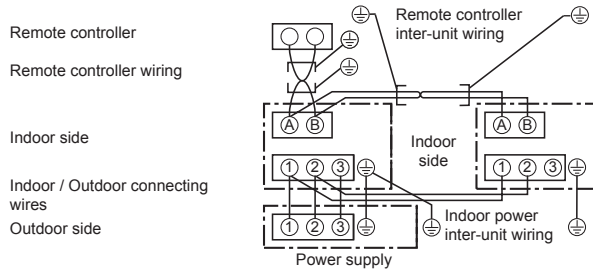

#### ▼ Simultaneous triple and double twin system

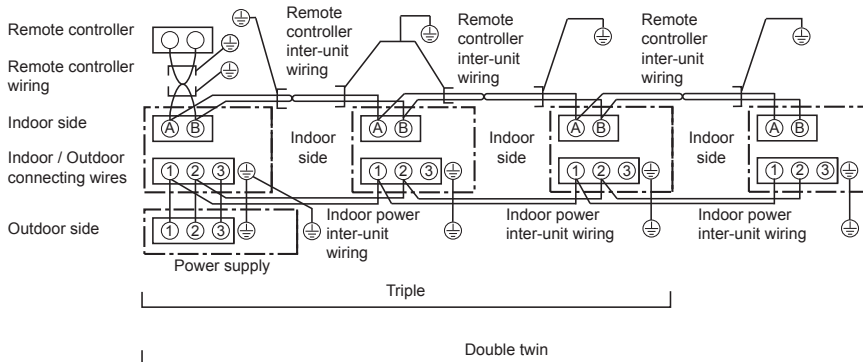

\* Use 2-core shield wire (MVVS 0.5 to 2.0 mm<sup>2</sup> or more) for the remote controller wiring in the simultaneous twin, simultaneous triple and simultaneous double twin systems to prevent noise problems. Be sure to connect both ends of the shield wire to earth leads.

\* Connect earth wires for each indoor unit in the simultaneous twin, simultaneous triple and simultaneous double twin systems.

## ■ Wired remote controller wiring

- As the wired remote controller wire has non-polarity, there is no problem if connections to indoor unit terminal blocks A and B are reversed.

### ▼ Wiring diagram

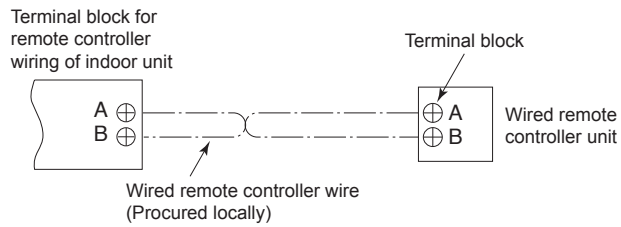

## ■ Wiring Connection

### How to connect the power supply wiring and control wiring

The power supply wire and the control wire can be connected without removing the front panel.

#### REQUIREMENT

Connect the power supply wire after connecting the control wire for this model.

1. Remove the air inlet grille.  
Open the air inlet grille upward and pull it toward you.
2. Remove the terminal cover and the clamp base.
3. Insert the power supply wire and control wire (according to the local rule) into the pipe hole on the wall.
4. Take the power supply wire out of the cable slot on the rear panel so that it protrudes about 150 mm from the front.
5. Insert the control wire fully into the control/wired remote controller terminal block (U<sub>3</sub>, U<sub>4</sub>, A, B) and secure it tightly with screws.
6. Clamp the control wire with the cord clamp.
7. Install the clamp base with a screw.
8. Insert the power supply wire fully into the terminal block and secure it tightly with screws. Tightening torque: 1.2 N·m (0.12 kgf·m) Secure the earth line with the earth screw.
9. Clamp the power supply wire with the cord clamp.
10. Attach the terminal cover and the air inlet grille to the indoor unit.

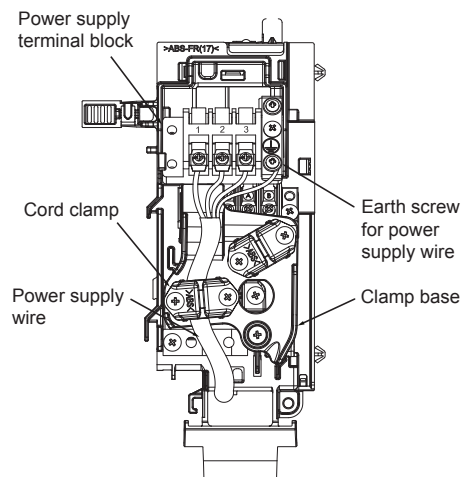
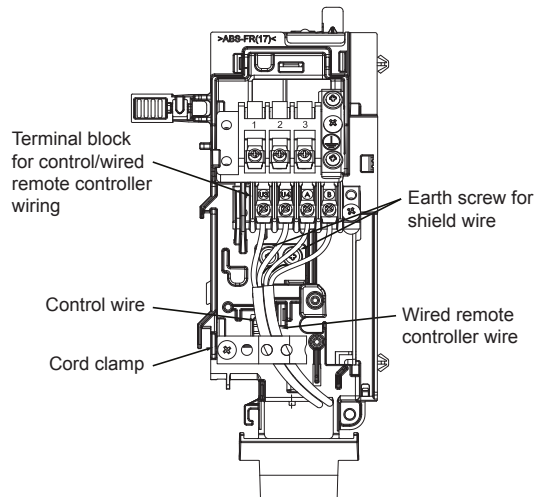
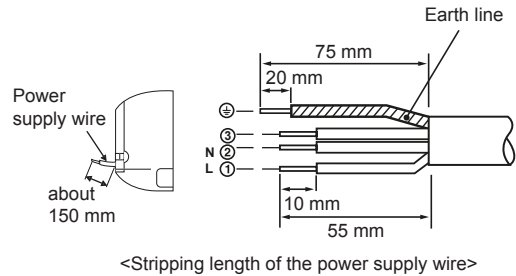
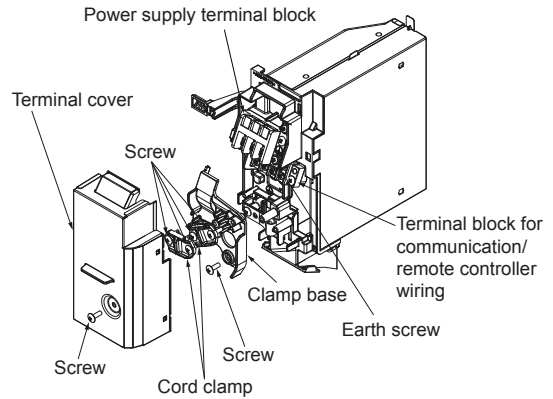

### CAUTION

- Be sure to refer to the wiring diagram attached inside the front panel.
- Check local electrical cords and also any specific wiring instructions and limitations.
- Do not catch the control wire when installing the clamp base.

## ■ Wiring connection (twin, triple, double twin system)

- 1** Connect a header unit by following the procedure of wiring connection for single system.
- 2** Connect Indoor / Outdoor connecting wires 1 and 2 of follower unit to terminal 1 and 2 on terminal block respectively. Indoor / Outdoor connecting wires 3 is not used.
- 3** Connect the earth wire to the earth screw located on the underside of the electrical control box.
- 4** Clamp the Indoor / Outdoor connecting wires with the cord clamp.
- 5** Attach the terminal cover and the air intake grille to the indoor unit.

### ▼ When using optional wired remote controller

The Indoor / Outdoor connecting wires and the wired remote controller wire can be connected without removing the front panel.

- 1** Remove the air intake grille.  
Open the air intake grille upward and pull it toward you.
- 2** Remove the terminal cover and the clamp base.
- 3** Insert the Indoor / Outdoor connecting wires and wired remote controller wire (according to the local rule) into the pipe hole on the wall.
- 4** Take the Indoor / Outdoor connecting wires and wired remote controller wire out of the cable slot on the rear panel so that it protrudes about 150 mm from the front.
- 5** Insert the wired remote controller wire fully into the wired remote controller / central control terminal block, (A), (B) and secure it tightly with screws.
  - Strip off approx. 9 mm the wire to be connected.
  - Non polarity, 2 core wire is used for wiring of the wired remote controller. (0.5 mm<sup>2</sup> to 2.0 mm<sup>2</sup> wires)

- 6** Clamp the wired remote controller wire with the cord clamp.
- 7** Install the clamp base with a screw.
- 8** Insert the Indoor / Outdoor connecting wires fully into the terminal block and secure it tightly with screws.  
Tightening torque: 1.2 N·m (0.12 kgf·m)  
Secure the earth wire with the earth screw.
- 9** Clamp the Indoor / Outdoor connecting wires with the cord clamp.
- 10** Attach the terminal cover and the air intake grille to the indoor unit.

### CAUTION

- Be sure to refer to the wiring diagram attached inside the front panel.
- Check local electrical cords and also any specific wiring instructions and limitations.
- Do not catch the wired remote controller wire when installing the clamp base.

# 11 APPLICABLE CONTROLS

- For using the wired remote controller RBC-AMS55E \*, refer to the Owner's Manual attached to the wired remote controller.

## REQUIREMENT

- When you use this air conditioner for the first time, it takes approx. 5 minutes until the remote controller becomes available after power-on. This is normal.

### <When power is turned on for the first time after installation>

It takes **approx. 5 minutes** until the remote controller becomes available.

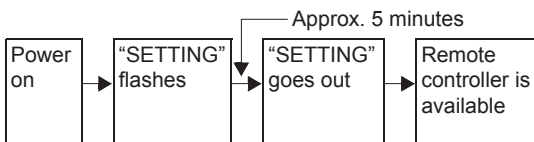

### <When power is turned on for the second (or later) time>

It takes **approx. 1 minute** until the remote controller becomes available.

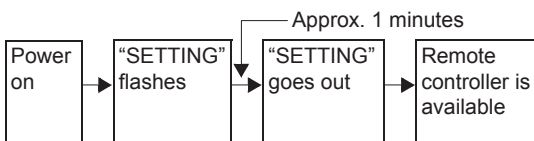

- Normal settings were made when the indoor unit was shipped from factory. Change the indoor unit settings as required.
- Use the wired remote controller to change the settings.
- \* The settings cannot be changed using the wireless remote controller, sub remote controller, or remote-controller less system (for central remote controller only). Therefore, install the wired remote controller to change the settings.

## ■ Applicable controls setup (settings at the site)

Remote controller model name:  
**RBC-ASCU1 \***

### Basic procedure

**Be sure to stop the air conditioner before making settings.**

(Change the setup while the air conditioner is not working.)

## ⚠ CAUTION

Set only the Code No. shown in the following table: Do NOT set any other Code No.

If a Code No. not listed is set, it may not be possible to operate the air conditioner or other trouble with the product may result.

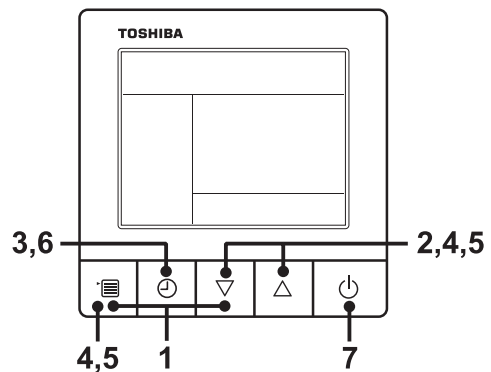

### 1 Push and hold menu button and [▽] setting button simultaneously for 10 seconds or more.

- After a while, the display flashes as shown in the figure. "ALL" is displayed as indoor unit numbers during initial communication immediately after the power has been turned on.

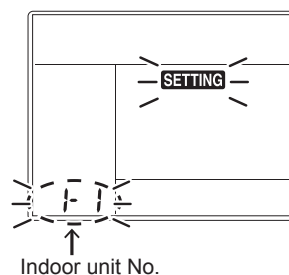

**2** Each time [▽][△] setting button is pushed, indoor unit numbers in the group control change cyclically. Select the indoor unit to change settings for.

- The fan of the selected indoor unit runs.  
The indoor unit can be confirmed for which to change settings.

**3** Push OFF timer button to confirm the selected indoor unit.

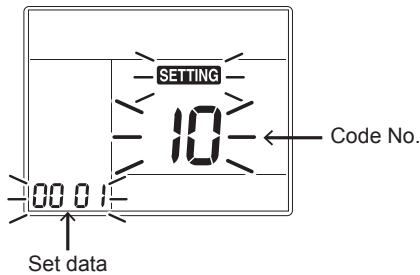

**4** Push the menu button to make Code No. [\*\*] flash. Change Code No. [\*\*] with [▽][△] setting button.

**5** Push the menu button to make Set data [\*\*\*\*] flash. Change Set data [\*\*\*\*] with [▽][△] setting button.

**6** Push OFF timer button.  
By doing so, the setup is completed.

- To change other settings of the selected indoor unit, repeat from Procedure 4.

**7** When all the settings have been completed, push ON/OFF button to determine the settings.

“SETTING” flashes and then the display content disappears and the air conditioner enters the normal stop mode. (The remote controller is unavailable while “SETTING” is flashing.)

- To change settings of another indoor unit, repeat from Procedure 1.

## ■ Change of lighting time of filter sign

According to the installation condition, the lighting time of the filter sign (Notification of filter cleaning) can be changed.

Follow to the basic operation procedure

(1 → 2 → 3 → 4 → 5 → 6).

- For the CODE No. in Procedure 4, specify [01].
- For the [SET DATA] in Procedure 5, select the SET DATA of filter sign lighting time from the following table.

SET DATA	Filter sign lighting time
0000	None
0001	150H (Factory setting)
0002	2500H
0003	5000H
0004	10000H

## ■ To secure better effect of heating

When it is difficult to obtain satisfactory heating due to installation place of the indoor unit or structure of the room, the detection temperature of heating can be raised. Also use a circulator, etc. to circulate heat air near the ceiling.

Follow to the basic operation procedure

(1 → 2 → 3 → 4 → 5 → 6).

- For the CODE No. in Procedure 4, specify [06].
- For the SET DATA in Procedure 5, select the SET DATA of shift value of detection temperature to be set up from the table below.

SET DATA	Detection temp shift value
0000	No shift
0001	+1°C
0002	+2°C (Factory setting)
0003	+3°C
0004	+4°C
0005	+5°C
0006	+6°C



## ■ Remote controller sensor

The temperature sensor of the indoor unit senses room temperature usually. Set the remote controller sensor to sense the temperature around the remote controller.

Select items following the basic operation procedure (1 → 2 → 3 → 4 → 5 → 6 → 7).

- Specify **[32]** for the Code No. in Procedure 4.
- Select the following data for the set data in Procedure 5.

Set data	Remote controller sensor
0000	Not in use (Factory default)
0001	In use

When  flashes, the remote controller sensor is defective.

Select the set data [0000] (not in use) or replace the remote controller.

## ■ Communication type

When connecting to the central control device dedicated to TCC-Link, it is necessary to change to TCC-Link.

Follow to the basic operation procedure (1 → 2 → 3 → 4 → 5 → 6 → 7).

- Specify **[FC]** for the Code No. in Procedure 4.
- Select the set data [0000] (TCC-Link) in Procedure 5.

Set data	Communication type
0000	TCC-Link
0004	TU2C-Link (Factory default)

## ■ Fan speed setting when thermostat-OFF in cooling mode

Set the fan speed when the room temperature reaches the set temperature in the cooling mode.

Follow to the basic operation procedure (1 → 2 → 3 → 4 → 5 → 6 → 7).

- Specify **[9A]** for the Code No. in Procedure 4.
- Select the following data for the set data in Procedure 5.

Set data	Fan speed when thermostat-OFF in cooling mode
0000	Remote controller setting
0001	Extremely low speed (UL) (Factory default)

## ■ 8°C operation

Pre-heating operation can be set for cold regions where room temperature drops to below zero.

Follow to the basic operation procedure (1 → 2 → 3 → 4 → 5 → 6 → 7).

- Specify **[d1]** for the Code No. in Procedure 4.
- Select the following data for the set data in Procedure 5.

Set data	8°C Operation setting
0000	None (Factory default)
0001	8°C Operation setting

## ■ Installing optional parts

When installing optional parts, data setup may be required with remote controller.

Be sure to set the data, according to Installation Manual for optional parts.

## ■ Information

The following functions require a connection with the RBC-AMTU \*\*\* and RBC-AMSU \*\*\* remote controller. For details, refer to the manual included with the remote controller.

- Individual unit selection during group operation
- Individual setting of louver position (wind direction)
- Swing type setting
- Louver lock (no swing) setting
- Energy saving operation (Power saving operation)
- Notification of filter cleaning time

## ■ Others

The following functions can be used with this model.

Refer to the Service Manual for more information.

- Rotation / backup operation
- Free cooling
- Secondary heating
- Power shift

## ■ Adjustment of air direction

1. Using the remote controller switch, change the up/down air direction by moving the horizontal louver.
2. Adjust the right/left air direction by bending the vertical grille inside of the air outlet port with hands.

### REQUIREMENT

Do not touch the horizontal louver directly with hands; otherwise a trouble may be caused. For handling of the horizontal louver, refer to "Owner's Manual" attached to the outdoor unit.

## ■ Group control

### Simultaneous twin system

A combination with an outdoor unit allows simultaneous ON / OFF operation of the indoor units.

The following system patterns are available.

- Two indoor units for the twin system

#### ▼ Twin system

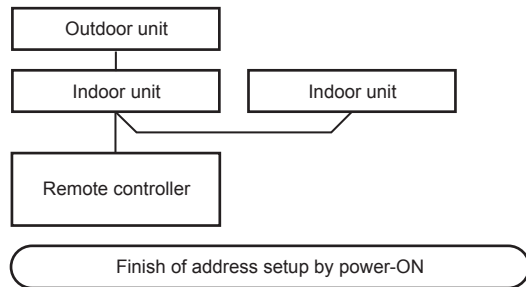

- For wiring procedure and wiring method, follow to the "Electrical connection" in this manual.
- When the power supply has been turned on, the automatic address setup starts and which indicates that address is being set up flashes on the display part.

During setup of automatic address, the remote controller operation is not accepted.

**Required time up to the finish of automatic addressing is approx. 5 minutes.**

## Group control for system of multiple units

One group can control up to 16 (TU2C-Link) or 8 (TCC-Link) indoor units with one remote controller. (Refer to the Wiring specifications)

### ▼ Group control in single system

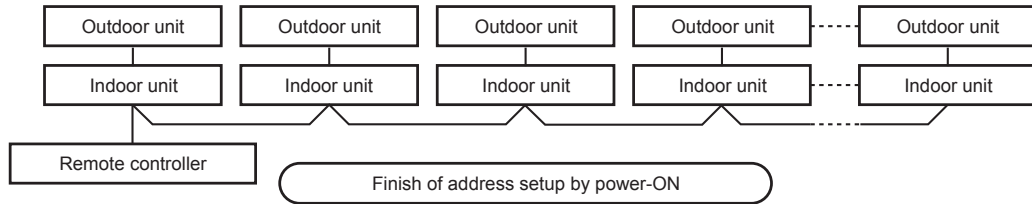

- For wiring procedure and wiring method of the individual line (identical refrigerant line) system, follow to “Electrical connection”.
- Wiring between lines is performed in the following procedure.  
Connect the terminal block (A / B) of the indoor unit connected with a remote controller to the terminal blocks (A / B) of the indoor units of other indoor units by wiring the inter-unit wire of the remote controller.
- When the power supply has been turned on, the automatic address setup starts and which indicates that address is being set up flashes on the display part in about 3 minutes. During setup of automatic address, the remote controller operation is not accepted.

**Required time up to the finish of automatic addressing is approx. 5 minutes.**

### NOTE

In some cases, it is necessary to change the address manually after setup of the automatic address according to the system configuration of the group control.

- The follow mentioned system configuration is a case when complex systems in which systems of the simultaneous twin and simultaneous triple unit is controlled as a group by a remote controller.

### (Example) Group control for complex system

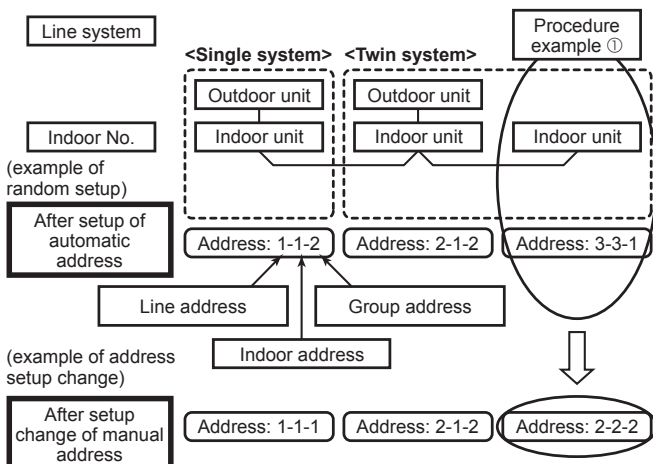

The above address is set by the automatic addressing when the power is turned on. However, line addresses and indoor addresses are set randomly. For this reason, change the setting to match line addresses with indoor addresses.

## ■ Manual address setting

---

- 1 Push and hold menu button and [▽] setting button simultaneously for 10 seconds or more.
- 2 Push OFF timer button to confirm the selected indoor unit.

### <Line address>

- 3 Push the menu button until the Code No. flashes. And using the [▽][△] buttons, specify the Code No. [12].
- 4 Push the menu button until the Set data flashes. And using the [▽][△] buttons, set a line address.
- 5 Push OFF timer button to confirm the Set data.

### <Indoor unit address>

- 6 Push the menu button until the Code No. flashes. And using the [▽][△] buttons, specify the Code No. [13].
- 7 Push the menu button until the Set data flashes. And using the [▽][△] buttons, set an indoor unit address.
- 8 Push OFF timer button to confirm the Set data.

### <Group address>

- 9 Push the menu button until the Code No. flashes. And using the [▽][△] buttons, specify the Code No. [14].
- 10 Push the menu button until the Set data flashes. And using the [▽][△] buttons, set a group address. If the indoor unit is individual, set the address to 0000. (header unit: 0001, follower unit: 0002)
- 11 Push OFF timer button to confirm the Set data.
- 12 When all the settings have been completed, push ON/OFF button to finish the settings. (Return to the normal mode)

## ■ To find an indoor unit's position from its address

---

- 1 Push and hold menu button and [▽] setting button simultaneously for 10 seconds or more. E.g.) A unit number 1-1 is indicated on the LCD of the remote controller. The indicated number shows the line (system) address and indoor unit address of the unit.
- 2 When 2 or more indoor units are connected to the remote controller (group-controlled units), a number of other connected units appears each time you push the [▽][△] buttons.
- 3 Push the ON/OFF button, return to the normal mode.

## ■ Central control system

Air conditioners at multiple locations can be controlled individually for each refrigeration system from a control room.

Central control is not available with the supplied wireless remote controller. Use the optional wired remote controller.

### ▼ Wiring for central control

The terminal block for central control wiring (U<sub>3</sub> and U<sub>4</sub>) is the same as that for optional wired remote controller. Connect the central control wire to the terminals (U<sub>3</sub> and U<sub>4</sub>) on the terminal block in the same way as the optional wired remote controller. For details, refer to the installation manual of the applicable central control system.

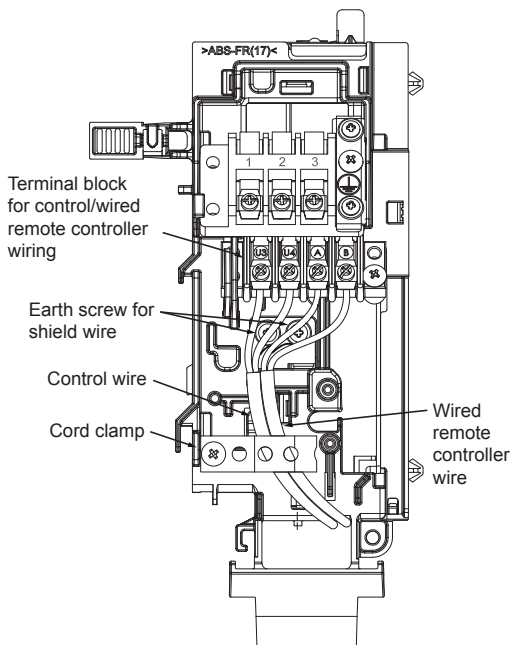

▼ Centrally control the system by the SDI, DI series on their own setting for the terminating resistor is required.

- Use switch SW01 for the setting.
- Make the terminating resistor setting only for the indoor unit with the smallest line address number.

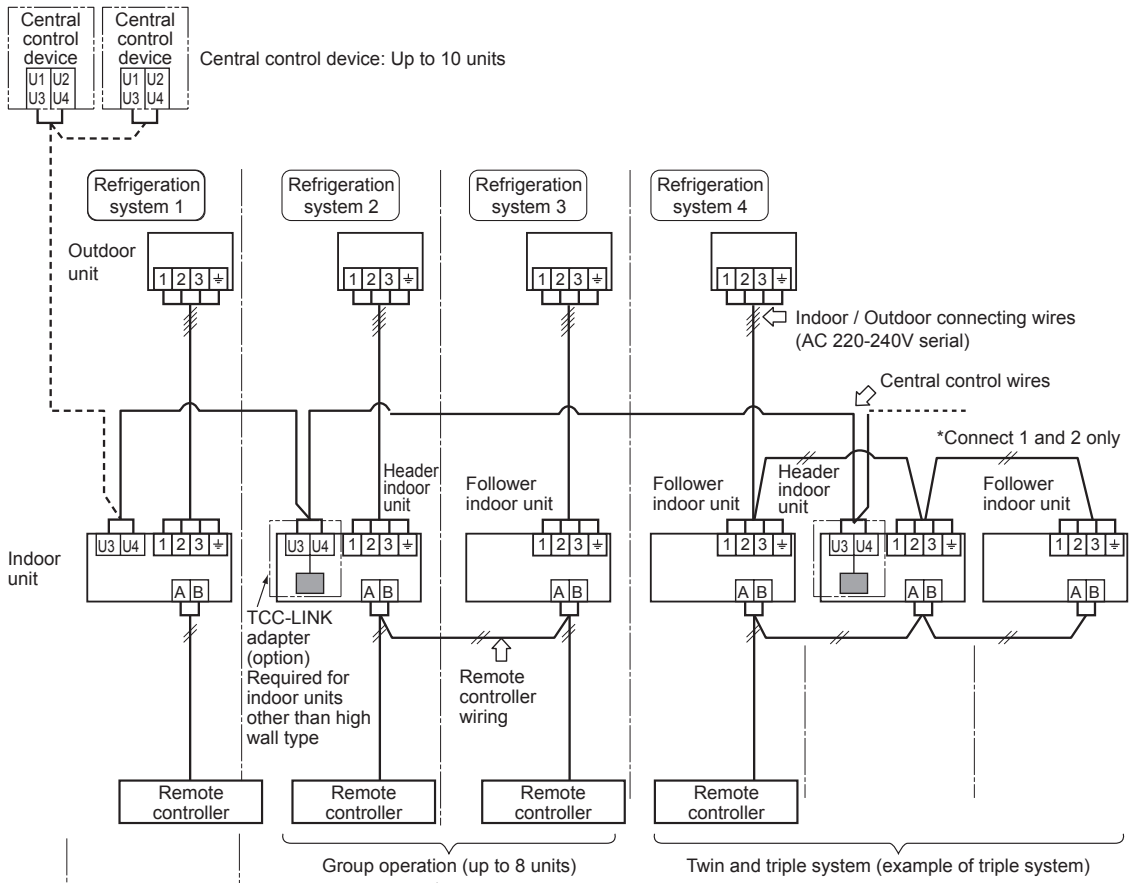

Line address	1	2		4	
SW01 bit1	ON	OFF		OFF	(OFF at factory default)
Remarks	Set bit1 of SW01 to ON	Factory default		Factory default	

## How to set the SW01

### 1 Remove the front panel.

- Before removing the front panel, direct the horizontal louver to the direction shown in the figure below.
- Remove the screws securing the front panel, and detach it from the indoor unit.

### 2 Remove the earth wire, TC sensor, TCJ sensor motor lead (louver motor, fan motor).

### 3 Remove the screws and detach the electrical control box.

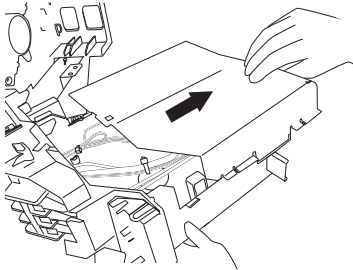

### 4 Remove the electrical control box cover and set bit1 of SW01 on the board to ON. (Do not touch SW02 as it is used for other setting.)

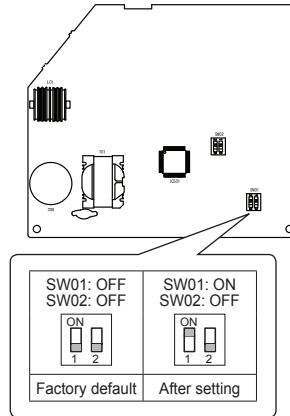

### 5 Assemble the removed parts by reversing steps 1 to 3.

Insert the sensors and motor lead (louver motor, fan motor) into the original positions.

## CAUTION

Connect the sensor and the motor lead certainly back to the previous position. If they are not properly connected, the system will not operate or other errors may occur.

▼ Centrally control the system by connecting to the TCC-LINK central control system.

**Setting central control addresses**

When air conditioners of the SDI, DI series are connected to the TCC-LINK central control system for central control using this product, set the addresses of indoor units using the following procedure.

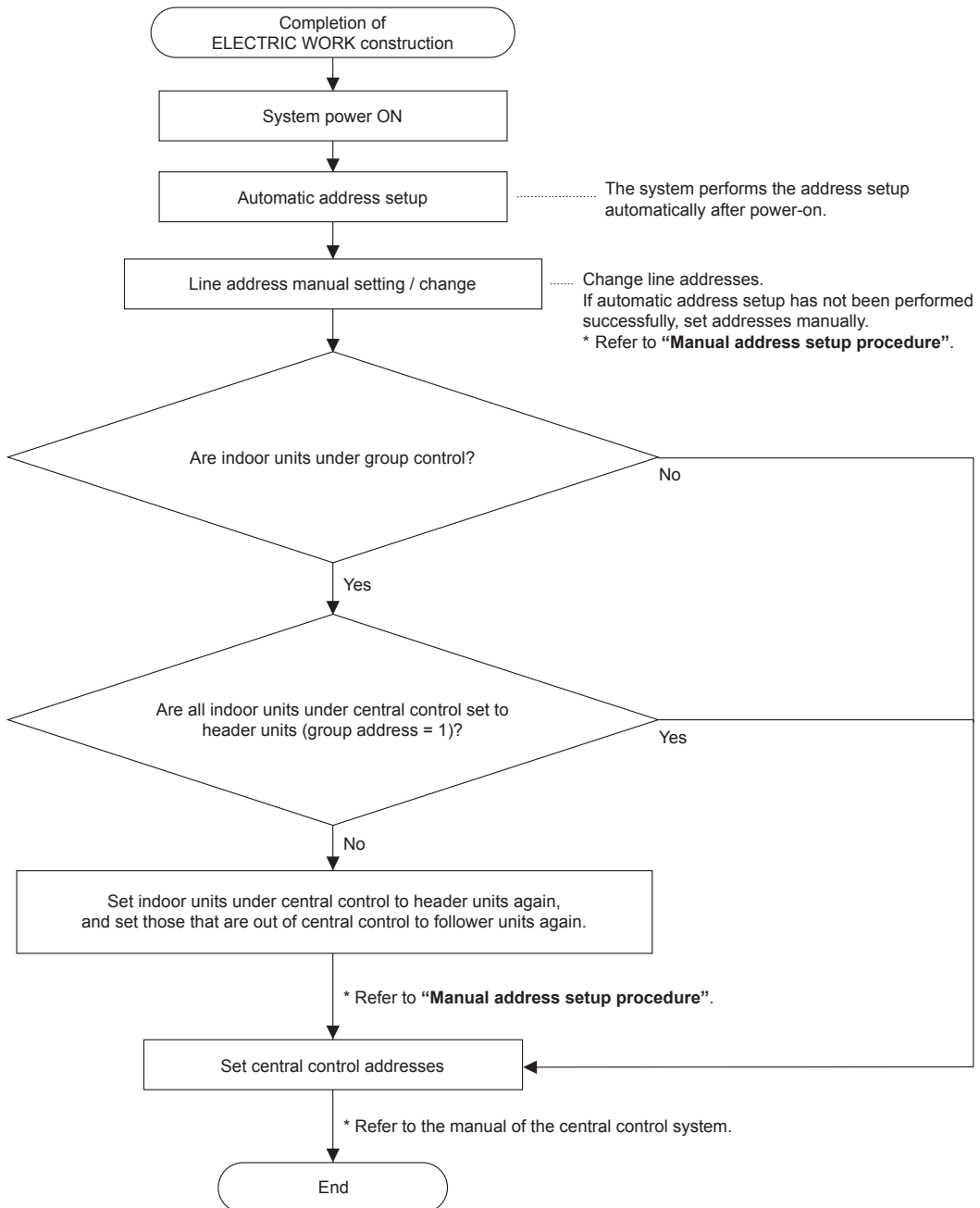



# 12 TEST RUN

A wired remote controller is necessary for this function. This function cannot be operate with a wireless remote controller.

## ■ Before test run

- Before turning on the power supply, carry out the following procedure.
  - 1) Using 500V-megger, check that resistance of 1MΩ or more exists between the terminal block of the power supply and the earth (grounding).  
If resistance of less than 1MΩ is detected, do not run the unit.
  - 2) Check the valve of the outdoor unit being opened fully.
- To protect the compressor at activation time, leave power-ON for 12 hours or more before operating.

## ■ Execute a test run

Operate the unit with the remote controller as usual.

For the procedure of the operation, refer to the attached Owner's Manual to the outdoor unit. A forced test run can be executed in the following procedure even if the operation stops by thermostat-OFF.

In order to prevent a serial operation, the forced test run is released after 60 minutes have passed and returns to the usual operation.

### CAUTION

- Do not use the forced test run for cases other than the test run because it applies an excessive load to the devices.

## Wired remote controller

**Be sure to stop the air conditioner before making settings.**

(Change the setup while the air conditioner is not working.)

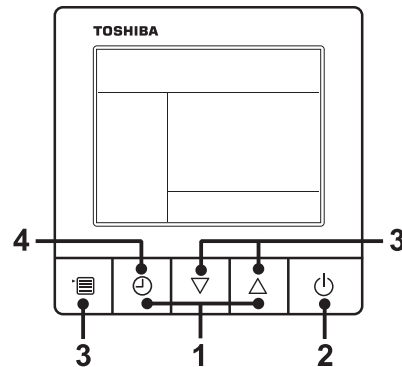

- 1** Push and hold OFF timer button and [△] setting button simultaneously for 10 seconds or more. [TEST] is displayed on the display part and the test run is permitted.

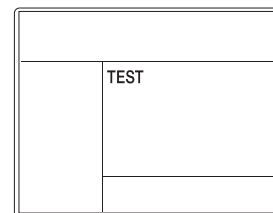

- 2** Push ON/OFF button.
- 3** Push menu button to select the operation mode. Select [Cool] or [Heat] with [▽] [△] setting button, and then push menu button (three times) again to determine the operation mode.
  - Do not run the air conditioner in a mode other than [Cool] or [Heat].
  - The temperature setting function does not work during test run.
  - The check code is displayed as usual.

- 4** After the test run, push OFF timer button to stop a test run.  
([TEST] disappears on the display and the air conditioner enters the normal stop mode.)

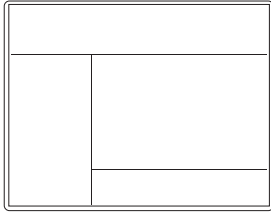

**Wireless remote controller**

- 1** Turn on the power of the air conditioner. When power is turned on for the first time after installation, it takes approx. 5 minutes until the remote controller becomes available. In the case of subsequent power-on, it takes approx. 1 minute until the remote controller becomes available. Execute a test run after the predetermined time has passed.
- 2** Push “ON/OFF” button on the remote controller, select [Cool] or [Heat] with “MODE” button, and then select [HIGH] with “FAN” button.

**3**

Cooling test run	Heating test run
Set the temperature to 17°C with the temp. setup buttons.	Set the temperature to 30°C with the temp. setup buttons.

**4**

Cooling test run	Heating test run
After confirming a signal receiving sound “beep” immediately set the temperature to 18°C with the temp. setup buttons.	After confirming a signal receiving sound “beep” immediately set the temperature to 29°C with the temp. setup buttons.

**5**

Cooling test run	Heating test run
After confirming a signal receiving sound “beep” immediately set the temperature to 17°C with the temp. setup buttons.	After confirming a signal receiving sound “beep” immediately set the temperature to 30°C with the temp. setup buttons.

- 6** Repeat procedures 4 → 5 → 4 → 5. Indicators “Operation” (green), “Timer” (green), and “Ready” (orange) in the wireless receiver section flash in approx. 10 seconds, and the air conditioner starts operation. If any of these indicators does not flash, repeat procedures 2 to 5.
- 7** Upon completion of the test run, push “ON/OFF” button to stop operation.

<Overview of test run operations using the wireless remote controller>

▼ **Cooling test run:**  
ON/OFF → 17°C → 18°C → 17°C → 18°C → 17°C → 18°C → 17°C → (test run) → ON/OFF

▼ **Heating test run:**  
ON/OFF → 30°C → 29°C → 30°C → 29°C → 30°C → 29°C → 30°C → (test run) → ON/OFF

**Wired remote controller**

- 1** When TEMPORARY button is pushed for 10 seconds or more, “Pi!” sound is heard and the operation changes to test run. After approx. 3 minutes, a cooling operation starts forcibly. Check cool air starts blowing. If the operation does not start, check wiring again.
- 2** To stop a test operation, push TEMPORARY button once again (Approx. 1 second). Check wiring / piping of the indoor and outdoor units in test run.

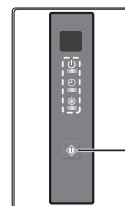

TEMPORARY button

## ■ When a test run is not performed properly

- When a test run is not performed properly, refer to the error code and the part to be checked on “Troubleshooting”.
- When a test run is executed before installing the external duct, a protection control may be activated and lets the unit stop and the code P12 may be displayed. (This is not due to a malfunction but to the current control function of the DC motor in this unit.)  
When a test run executed before installing the external duct, select “Low” for the fan speed level or cover the air discharge.
- In addition, stop the operation before replacing the High-efficiency filter or opening the service panel.  
After the test run, reset the circuit breaker of the indoor unit.

## ■ Monitoring function

This function can be used to call the service monitor mode from the remote controller during a test run to obtain the temperature of the sensors of the remote controller, indoor unit, and outdoor unit.

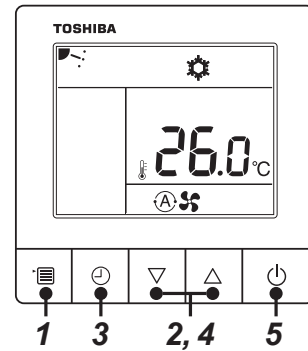

“Monitoring function” display

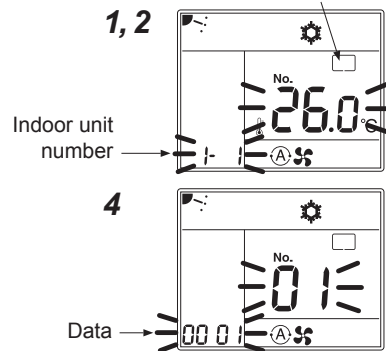

- 1** Push and hold menu button for 10 seconds or more. “Monitoring function” is displayed on a screen.
- 2** Every pushing [▽] [△] buttons, the indoor unit numbers in group control are displayed successively.
- 3** Push OFF timer button to confirm the selected indoor unit.
- 4** Every pushing [▽] [△] buttons, Code No. of the item is changed successively.
- 5** After you have finished checking, push “ON/OFF” button, return to normal mode.

Indoor unit data	
Code No.	Data name
01	Room temperature (remote controller)
02	Indoor unit intake air temperature (TA)
03	Indoor unit heat exchanger (coil) temperature (TCJ)
04	Indoor unit heat exchanger (coil) temperature (TC)
07	Indoor unit fan speed (×1 rpm)
B9	Communication protocol (0000: TCC-Link, 0001: TU2C-Link)
F3	Indoor unit fan cumulative operating hours (×1 h)
F8	Indoor unit discharge air temperature *1

Outdoor unit data *2	
Code No.	Data name
60	Outdoor unit heat exchanger (coil) temperature (TE)
61	Outside air temperature (TO)
62	Compressor discharge temperature (TD)
63	Compressor suction temperature (TS)
65	Heatsink temperature (THS)
6A	Operating current (×1/10)
6D	Outdoor heat exchange (coil) temperature (TL)
F1	Compressor cumulative operating hours (×100 h)

\*1 : The above temperature values are estimated from the temperature of the heat exchanger. It may differ from the actual discharge temperature.

\*2 : For outdoor unit data, refer to the Installation Manual and Service Manual of the outdoor unit.

**In case of wireless remote controller (Forced test operation is performed in a different way.)**

**REQUIREMENT**

- For the operation procedure, be sure to follow the Owner's Manual.
- Finish the forced cooling operation in a short time because it applies excessive strength to the air conditioner.
- A test operation of forced heating is unavailable. Perform a test operation by heating operation using the switches of the remote controller. However heating operation may be not carried out according to the temperature conditions.

**• Check wiring/piping of indoor and outdoor units**

1. When pushing [RESET] button for 10 seconds or more, "Pi!" sound is heard and the operation changes to a forced cooling operation. After approx. 3 minutes, a cooling operation starts forcedly. Check cool air starts blowing. If the operation does not start, check wiring again.
2. To stop a test operation, push [RESET] button once again (Approx. 1 second). The louver closes and the operation stops.

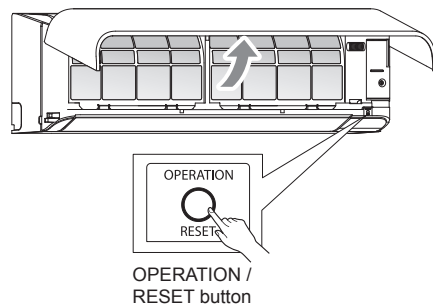



**• Check transmission of remote controller**

1. Push "START/STOP" button of the remote controller to check an operation can also start by the remote controller.
  - "Cooling" operation by the remote controller may be unavailable according to the temperature conditions. Check wiring/piping of the indoor and outdoor units in forced cooling operation.

# 13 MAINTENANCE

## ◆ Daily maintenance

### Cleaning of air filter

- 1 Push the  button to stop the operation, then turn off the circuit breaker. After the cooling or dry operation, the ventilation fan keeps running for self-cleaning. Push the  button twice to stop the operation.

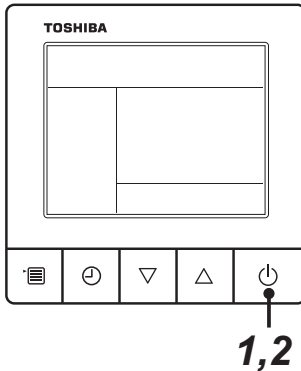

### Mount the air filter

- 2 Turn on the circuit breaker, then push the  button on the remote controller to start the operation.

### CAUTION

- Do not start the air conditioner while leaving air filter removed.

### Take out the air filter

- 1 Open the air intake grille until it stops, and slightly raise the hook on the lower centre of the air filter. The air intake grille should not be opened further; otherwise, the arms may come off and the air intake grille may fall down.

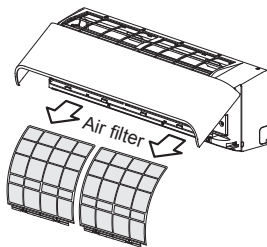

### Cleaning with water or vacuum cleaner

- If dirt is heavy, clean the air filter by tepid water with neutral detergent or water.
- After cleaning with water, dry the air filter sufficiently in a shade place.

## ◆ Periodic maintenance

For environmental conservation, it is strongly recommended that the indoor and outdoor units of the air conditioner in use be cleaned and maintained regularly to ensure efficient operation of the air conditioner. When the air conditioner is operated for a long time, periodic maintenance (once a year) is recommended. Furthermore, regularly check the outdoor unit for rust and scratches, and remove them or apply rustproof treatment, if necessary.

As a general rule, when an indoor unit is operated for 8 hours or more daily, clean the indoor unit and outdoor unit at least once every 3 months. Ask a professional for this cleaning / maintenance work. Such maintenance can extend the life of the product though it involves the owner's expense.

Failure to clean the indoor and outdoor units regularly will result in poor performance, freezing, water leakage, and even compressor failure.

### Inspection before maintenance

Following inspection must be carried out by a qualified installer or qualified service person.

Part	Inspection method
Heat exchanger	Access from inspection opening and remove the access panel. Examine the heat exchanger if there is any clogging or damages.
Fan motor	Access from inspection opening and check if any abnormal noise can be heard.
Fan	Access from inspection opening and remove the access panel. Examine the fan if there are any waggles, damages or adhesive dust.
Filter	Go to installed location and check if there are any stains or breaks on the filter.
Drain pan	Access from inspection opening and remove the access panel. Check if there is any clogging or drain water is polluted.

### ▼ Maintenance List

Part	Unit	Check (visual / auditory)	Maintenance
Heat exchanger	Indoor / outdoor	Dust / dirt clogging, scratches	Wash the heat exchanger when it is clogged.
Fan motor	Indoor / outdoor	Sound	Take appropriate measures when abnormal sound is generated.
Filter	Indoor	Dust / dirt, breakage	<ul style="list-style-type: none"> <li>• Wash the filter with water when it is contaminated.</li> <li>• Replace it when it is damaged.</li> </ul>
Fan	Indoor	<ul style="list-style-type: none"> <li>• Vibration, balance</li> <li>• Dust / dirt, appearance</li> </ul>	<ul style="list-style-type: none"> <li>• Replace the fan when vibration or balance is terrible.</li> <li>• Brush or wash the fan when it is contaminated.</li> </ul>
Air intake / discharge grilles	Indoor / outdoor	Dust / dirt, scratches	Fix or replace them when they are deformed or damaged.
Drain pan	Indoor	Dust / dirt clogging, drain contamination	Clean the drain pan and check the downward slope for smooth drainage.
Ornamental panel, louvers	Indoor	Dust / dirt, scratches	Wash them when they are contaminated or apply repair coating.
Exterior	Outdoor	<ul style="list-style-type: none"> <li>• Rust, peeling of insulator</li> <li>• Peeling / lift of coat</li> </ul>	Apply repair coating.

# 14 TROUBLESHOOTING

## ■ Confirmation and check

If a problem occurs with the air conditioner, the OFF timer indicator alternately shows the check code and the indoor Unit No. in which the problem occurred.

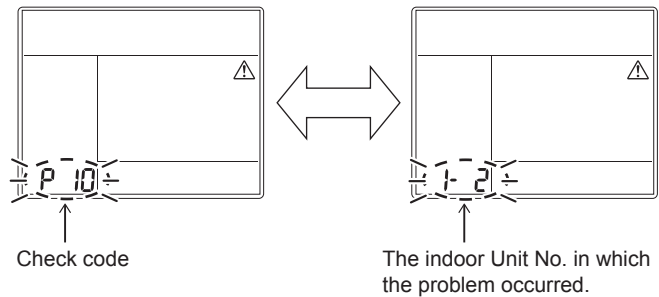

## ■ Troubleshooting history and confirmation

You can check the troubleshooting history with the following procedure if a problem occurs with the air conditioner.

(The troubleshooting history records up to 4 incidents.)

You can check it during operation or when operation is stopped.

- If you check the troubleshooting history during OFF timer operation, the OFF timer will be canceled.

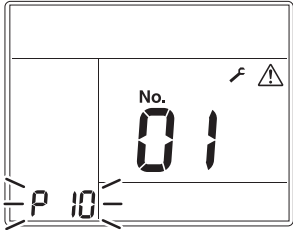
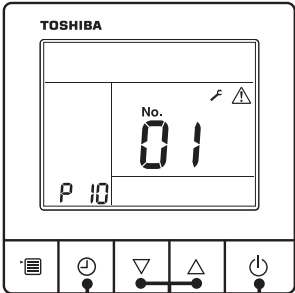
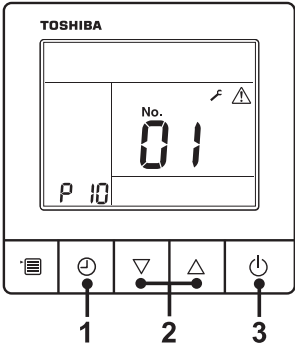
Procedure	Description of operation
<p>1</p>	<p>Push the OFF timer button for over 10 seconds and the indicators appear as an image indicating the troubleshooting history mode has been entered. If [Service check] is displayed, the mode enters in the troubleshooting history mode.</p> <ul style="list-style-type: none"> <li>• [01: Order of troubleshooting history] appears in the temperature indicator.</li> <li>• The OFF timer indicator alternately shows the [check code] and the [indoor Unit No. ] in which the problem occurred.</li> </ul> 
<p>2</p>	<p>Each time the setting button is pushed, the recorded troubleshooting history is displayed in sequence. The troubleshooting history appears in order from [01] (newest) to [04] (oldest).</p> <p style="text-align: center;"><b>⚠ CAUTION</b></p> <p>In the troubleshooting history mode, DO NOT push the Menu button for over 10 seconds, doing so deletes the entire troubleshooting history of the indoor unit.</p> 
<p>3</p>	<p>After you have finished checking, push the ON/OFF button to return to the regular mode.</p> <ul style="list-style-type: none"> <li>• If the air conditioner is operating, it remains operated even after the ON/OFF button has been pushed. To stop its operation, push the ON/OFF button again.</li> </ul> 

## ■ Error codes and parts to be checked

Wired remote controller display	Wireless remote controller Sensor block display of receiving unit		Main defective parts	Judging device	Parts to be checked / error description	Air conditioner status
	Indication	Operation Timer Ready GR GR OR				
E01	◎ ● ●		No header remote controller	Remote controller	Incorrect remote controller setting --- The header remote controller has not been set (including two remote controllers).	*
			Remote controller communication error		No signal can be received from the indoor unit.	
E02	◎ ● ●		Remote controller transmission error	Remote controller	Indoor / Outdoor connecting wires, indoor P.C. board, remote controller. --- No signal can be sent to the indoor unit.	*
E03	◎ ● ●		Indoor unit-remote controller regular communication error	Indoor	Remote controller, network adapter, indoor P.C. board --- No data is received from the remote controller or network adapter.	Auto-reset
E04	● ● ◎		Indoor unit-outdoor unit serial communication error	Indoor	Indoor / Outdoor connecting wires, indoor P.C. board, outdoor P.C. board --- Serial communication error between indoor unit and outdoor unit	Auto-reset
			IPDU-CDB communication error			
E08	◎ ● ●		Duplicated indoor addresses ★	Indoor	Indoor address setting error --- The same address as the self-address was detected.	Auto-reset
E09	◎ ● ●		Duplicated header remote controllers	Remote controller	Remote controller address setting error --- Two remote controllers are set as header in the double-remote controller control.	*
					(* The header indoor unit stops raising alarm and follower indoor units continue to operate.)	
E10	◎ ● ●		CPU-CPU communication error	Indoor	Indoor P.C. board --- Communication error between main MCU and motor microcomputer MCU.	Auto-reset
E11	◎ ● ●		Communication trouble between Application control kit and Indoor unit	Indoor	Communication trouble between Application control kit and Indoor unit	Entire stop
E18	◎ ● ●		Header unit follower unit regular communication error	Indoor	Indoor P.C. board --- Regular communication is not possible between header and follower indoor units or between twin header (main) and follower (sub) units.	Auto-reset
E31	● ● ◎		IPDU communication error	Outdoor	Communication error between IPDU and CDB.	Entire stop
F01	◎ ◎ ●	ALT	Indoor unit heat exchanger sensor (TCJ) error	Indoor	Heat exchanger sensor (TCJ), indoor P.C. board --- Open-circuit or short-circuit of the heat exchanger sensor (TCJ) was detected.	Auto-reset
F02	◎ ◎ ●	ALT	Indoor unit heat exchanger sensor (TC) error	Indoor	Heat exchanger sensor (TC), indoor P.C. board --- Open-circuit or short-circuit of the heat exchanger sensor (TC) was detected.	Auto-reset
F04	◎ ◎ ○	ALT	Outdoor unit discharge temp. sensor (TD) error	Outdoor	Outdoor temp. sensor (TD), outdoor P.C. board --- Open-circuit or short-circuit of the discharge temp. sensor was detected.	Entire stop
F06	◎ ◎ ○	ALT	Outdoor unit temp. sensor (TE / TS) error	Outdoor	Outdoor temp. sensors (TE / TS), outdoor P.C. board --- Open-circuit or short-circuit of the heat exchanger temp. sensor was detected.	Entire stop
F07	◎ ◎ ○	ALT	TL sensor error	Outdoor	TL sensor may be displaced, disconnected or short-circuited.	Entire stop
F08	◎ ◎ ○	ALT	Outdoor unit outside air temp. sensor error	Outdoor	Outdoor temp. sensor (TO), outdoor P.C. board --- Open-circuit or short-circuit of the outdoor air temp. sensor was detected.	Operation continued



Wired remote controller display	Wireless remote controller Sensor block display of receiving unit		Main defective parts	Judging device	Parts to be checked / error description	Air conditioner status
	Indication	Operation Timer Ready GR GR OR				
F10	◎ ◎ ●	ALT	Indoor unit room temp. sensor (TA) error	Indoor	Room temp. sensor (TA), indoor P.C. board --- Open-circuit or short-circuit of the room temp. sensor (TA) was detected.	Auto-reset
F12	◎ ◎ ○	ALT	TS sensor error	Outdoor	TS sensor may be displaced, disconnected or short-circuited.	Entire-stop
F13	◎ ◎ ○	ALT	Heat sink sensor error	Outdoor	Abnormal temperature was detected by the temp. sensor of the IGBT heat sink.	Entire stop
F15	◎ ◎ ○	ALT	Temp. sensor connection error	Outdoor	Temp. sensor (TE / TS) may be connected incorrectly.	Entire stop
F29	◎ ◎ ●	SIM	Indoor unit, other P.C. board error	Indoor	Indoor P.C. board --- EEPROM error.	Auto-reset
F30	◎ ◎ ○	SIM	Occupancy sensor trouble	Indoor	Abnormality was detected from occupancy sensor.	Operation continued
F31	◎ ◎ ○	SIM	Outdoor unit P.C. board	Outdoor	Outdoor P.C. board ---- In the case of EEPROM error.	Entire stop
H01	● ◎ ●		Outdoor unit compressor breakdown	Outdoor	Current detect circuit, power voltage --- Minimum frequency was reached in the current releasing control or short-circuit current (Idc) after direct excitation was detected.	Entire stop
H02	● ◎ ●		Outdoor unit compressor lock	Outdoor	Compressor circuit --- Compressor lock was detected.	Entire stop
H03	● ◎ ●		Outdoor unit current detect circuit error	Outdoor	Current detect circuit, outdoor unit P.C. board --- Abnormal current was detected in AC-CT or a phase loss was detected.	Entire stop
H04	● ◎ ●		Case thermostat operation	Outdoor	Malfunction of the case thermostat	Entire stop
H06	● ◎ ●		Outdoor unit low-pressure system error	Outdoor	Current, high-pressure switch circuit, outdoor P.C. board --- Pressure sensor error was detected or low-pressure protective operation was activated.	Entire stop
L03	◎ ● ◎	SIM	Duplicated header indoor units ★	Indoor	Indoor address setting error --- There are two or more header units in the group.	Entire stop
L07	◎ ● ◎	SIM	Group line in individual indoor unit ★	Indoor	Indoor address setting error --- There is at least one group-connected indoor unit among individual indoor units.	Entire stop
L08	◎ ● ◎	SIM	Indoor group address not set ★	Indoor	Indoor address setting error --- Indoor address group has not been set.	Entire stop
L09	◎ ● ◎	SIM	Indoor unit capacity not set	Indoor	Indoor unit capacity has not been set.	Entire stop
L10	◎ ○ ◎	SIM	Outdoor unit P.C. board	Outdoor	In the case of outdoor P.C. board jumper wire (for service) setting error.	Entire stop
L20	◎ ○ ◎	SIM	LAN communication error	Network adapter central control	Address setting, central control remote controller, network adapter --- Duplication of address in central control communication.	Auto-reset
L29	◎ ○ ◎	SIM	Other outdoor unit error	Outdoor	Other outdoor unit error.	Entire stop
					1) Communication error between IPDU MCU and CDB MCU. 2) Abnormal temperature was detected by the heat sink temp. sensor in IGBT.	Entire stop
L30	◎ ○ ◎	SIM	Abnormal external input into indoor unit (interlock)	Indoor	External devices, outdoor unit P.C. board --- Abnormal stop due to incorrect external input into CN80.	Entire stop
L31	◎ ○ ◎	SIM	Phase sequence error, etc.	Outdoor	Power supply phase sequence, outdoor unit P.C. board --- Abnormal phase sequence of the 3-phase power supply.	Operation continued (thermostat OFF)

Wired remote controller display	Wireless remote controller Sensor block display of receiving unit		Main defective parts	Judging device	Parts to be checked / error description	Air conditioner status
	Indication	Operation Timer Ready GR GR OR				
P01	● ○ ○	ALT	Indoor unit fan error	Indoor	Indoor fan motor, indoor P.C. board --- Indoor AC fan error (fan motor thermal relay activated) was detected.	Entire stop
P03	○ ● ○	ALT	Outdoor unit discharge temp. error	Outdoor	An error was detected in the discharge temp. releasing control.	Entire stop
P04	○ ● ○	ALT	Outdoor unit high-pressure system error	Outdoor	High-pressure switch --- The IOL was activated or an error was detected in the high-pressure releasing control using the TE.	Entire stop
P05	○ ● ○	ALT	Open phase detected	Outdoor	The power wire may be connected incorrectly. Check open phase and voltages of the power supply.	Entire stop
P07	○ ● ○	ALT	Heat sink overheat	Outdoor	Abnormal temperature was detected by the temp. sensor of the IGBT heat sink.	Entire stop
P10	● ○ ○	ALT	Indoor unit water overflow detected	Indoor	Drain pipe, clogging of drainage, float switch circuit, indoor P.C. board --- Drainage is out of order or the float switch was activated.	Entire stop
P12	● ○ ○	ALT	Abnormal operation of the fan of the indoor unit	Indoor	Abnormal operation of the indoor fan motor, indoor P.C. board, or indoor DC fan (over current or lock, etc.) is detected.	Entire stop
P15	○ ● ○	ALT	Gas leakage detected	Outdoor	There may be gas leakage from the pipe or connecting part. Check for gas leakage.	Entire stop
P19	○ ● ○	ALT	4-way valve error	Outdoor (Indoor)	4-way valve, indoor temp. sensors (TC / TCJ) --- An error was detected due to temperature drop of the indoor unit heat exchanger sensor during heating.	Auto-reset
P20	○ ● ○	ALT	High-pressure protective operation	Outdoor	High-pressure protection.	Entire stop
P22	○ ● ○	ALT	Outdoor unit fan error	Outdoor	Outdoor unit fan motor, outdoor unit P.C. board --- An error (overcurrent, locking, etc.) was detected in the outdoor unit fan drive circuit.	Entire stop
P26	○ ● ○	ALT	Outdoor unit inverter Idc activated	Outdoor	IGBT, outdoor unit P.C. board, inverter wiring, compressor --- Short-circuit protection for compressor drive circuit devices (G-Tr / IGBT) was activated.	Entire stop
P29	○ ● ○	ALT	Outdoor unit position error	Outdoor	Outdoor unit P.C. board, high-pressure switch --- Compressor motor position error was detected.	Entire stop
P31	○ ● ○	ALT	Other indoor unit error	Indoor	Another indoor unit in the group is raising an alarm.	Entire stop
					E03 / L07 / L03 / L08 alarm check locations and error description.	Auto-reset

○ : Lighting ◎ : Flashing ● : OFF ★ : The air conditioner automatically enters the auto-address setting mode.  
 ALT : When two LEDs are flashing, they flash alternately. SIM: When two LEDs are flashing, they flash in synchronization.  
 Receiving unit display OR : Orange GR : Green

# 15 SPECIFICATIONS

Model	Sound pressure level (dBA)		Weight (kg)
	Cooling	Heating	
RAV-HM561KRTP-E	*	*	14
RAV-HM801KRTP-E	*	*	14
RAV-HM901KRTP-E	*	*	14

\* Under 70 dBA

## Declaration of Conformity

Manufacturer: Toshiba Carrier (Thailand) Co., Ltd.  
144/9 Moo 5, Bangkadi Industrial Park, Tivanon road, Tambol Bangkadi,  
Amphur Muang, Pathumthani 12000, Thailand

TCF holder: TOSHIBA CARRIER EUROPE S.A.S  
Route de Thil 01120 Montluel FRANCE

Hereby declares that the machinery described below:

Generic Denomination: Air Conditioner

Model / type: RAV-HM561KRTP-E,  
RAV-HM801KRTP-E,  
RAV-HM901KRTP-E

Commercial name: Digital Inverter Series / Super Digital Inverter Series Air Conditioner

Complies with the provisions of the Machinery Directive (Directive 2006/42/EC) and the regulations transposing into national law

Name: Masaru Takeyama  
Position: GM, Quality Assurance Dept.  
Date: 5 April, 2022  
Place Issued: Thailand

### NOTE

This declaration becomes invalid if technical or operational modifications are introduced without the manufacturer's consent.

## Declaration of Conformity

Manufacturer: Toshiba Carrier (Thailand) Co., Ltd.  
144/9 Moo 5, Bangkadi Industrial Park, Tivanon road, Tambol Bangkadi,  
Amphur Muang, Pathumthani 12000, Thailand

TCF holder: TOSHIBA CARRIER UK LTD.  
Porsham Close Belliver Industrial Estate Roborough Plymouth Devon  
PL6 7DB United Kingdom

Hereby declares that the machinery described below:

Generic Denomination: Air Conditioner

Model / type: RAV-HM561KRTP-E,  
RAV-HM801KRTP-E,  
RAV-HM901KRTP-E

Commercial name: Digital Inverter Series / Super Digital Inverter Series Air Conditioner

Complies with the provisions of the Supply of Machinery (Safety) Regulations 2008

Name: Masaru Takeyama  
Position: GM, Quality Assurance Dept.  
Date: 5 April, 2022  
Place Issued: Thailand

### NOTE

This declaration becomes invalid if technical or operational modifications are introduced without the manufacturer's consent.

# 16 APPENDIX

## Work instructions

The existing R22 and R410A piping can be reused for inverter R32 product installations.

### WARNING

**Confirming the existence of scratches or dents on the existing pipes and confirming the reliability of the pipe strength are conventionally referred to the local site. If the specified conditions can be cleared, it is possible to update existing R22 and R410A pipes to those for R32 models.**

## Basic conditions needed to reuse existing pipes

Check and observe the presence of three conditions in the refrigerant piping works.

1. **Dry** (There is no moisture inside of the pipes.)
2. **Clean** (There is no dust inside of the pipes.)
3. **Tight** (There are no refrigerant leaks.)

## Restrictions for use of existing pipes

**In the following cases, the existing pipes should not be reused as they are. Clean the existing pipes or exchange them with new pipes.**

1. When a scratch or dent is heavy, be sure to use new pipes for the refrigerant piping works.
2. When the existing pipe thickness is thinner than the specified "Pipe diameter and thickness," be sure to use new pipes for the refrigerant piping works.
  - The operating pressure of refrigerant is high. If there is a scratch or dent on the pipe or a thinner pipe is used, the pressure strength may be inadequate, which may cause the pipe to break in the worst case.

### \* Pipe diameter and thickness (mm)

Pipe outer diameter		Ø6.4	Ø9.5	Ø12.7	Ø15.9
Thickness	R32, R410A	0.8	0.8	0.8	1.0
	R22				

3. When the outdoor unit was left with the pipes disconnected, or the gas leaked from the pipes and the pipes were not repaired and refilled.
  - There is the possibility of rain water or air, including moisture, entering the pipe.
4. When refrigerant cannot be recovered using a refrigerant recovery unit.
  - There is the possibility that a large quantity of dirty oil or moisture remains inside the pipes.

5. When a commercially available dryer is attached to the existing pipes.
  - There is the possibility that copper green rust has been generated.
6. When the existing air conditioner is removed after refrigerant has been recovered. Check if the oil is judged to be clearly different from normal oil.
  - The refrigerator oil is copper rust green in color:
 

There is the possibility that moisture has mixed with the oil and rust has been generated inside the pipe.
  - There is discolored oil, a large quantity of residue, or a bad smell.
  - A large quantity of shiny metal dust or other wear residue can be seen in the refrigerant oil.
7. When the air conditioner has a history of the compressor failing and being replaced.
  - When discolored oil, a large quantity of residue, shiny metal dust, or other wear residue or mixture of foreign matter is observed, trouble will occur.
8. When temporary installation and removal of the air conditioner are repeated such as when leased etc.
9. If the type of refrigerator oil of the existing air conditioner is other than the following oil (Mineral oil), Suniso, Freol-S, MS (Synthetic oil), alkyl benzene (HAB, Barrel-freeze), ester series, PVE only of ether series.
  - The winding-insulation of the compressor may deteriorate.

### NOTE

The above descriptions are results have been confirmed by our company and represent our views on our air conditioners, but do not guarantee the use of the existing pipes of air conditioners that have adopted R32 in other companies.

## Curing of pipes

When removing and opening the indoor or outdoor unit for a long time, cure the pipes as follows:

- Otherwise rust may be generated when moisture or foreign matter due to condensation enters the pipes.
- The rust cannot be removed by cleaning, and new pipes are necessary.

Placement location	Term	Curing manner
Outdoors	1 month or more	Pinching
	Less than 1 month	Pinching or taping
Indoors	Every time	

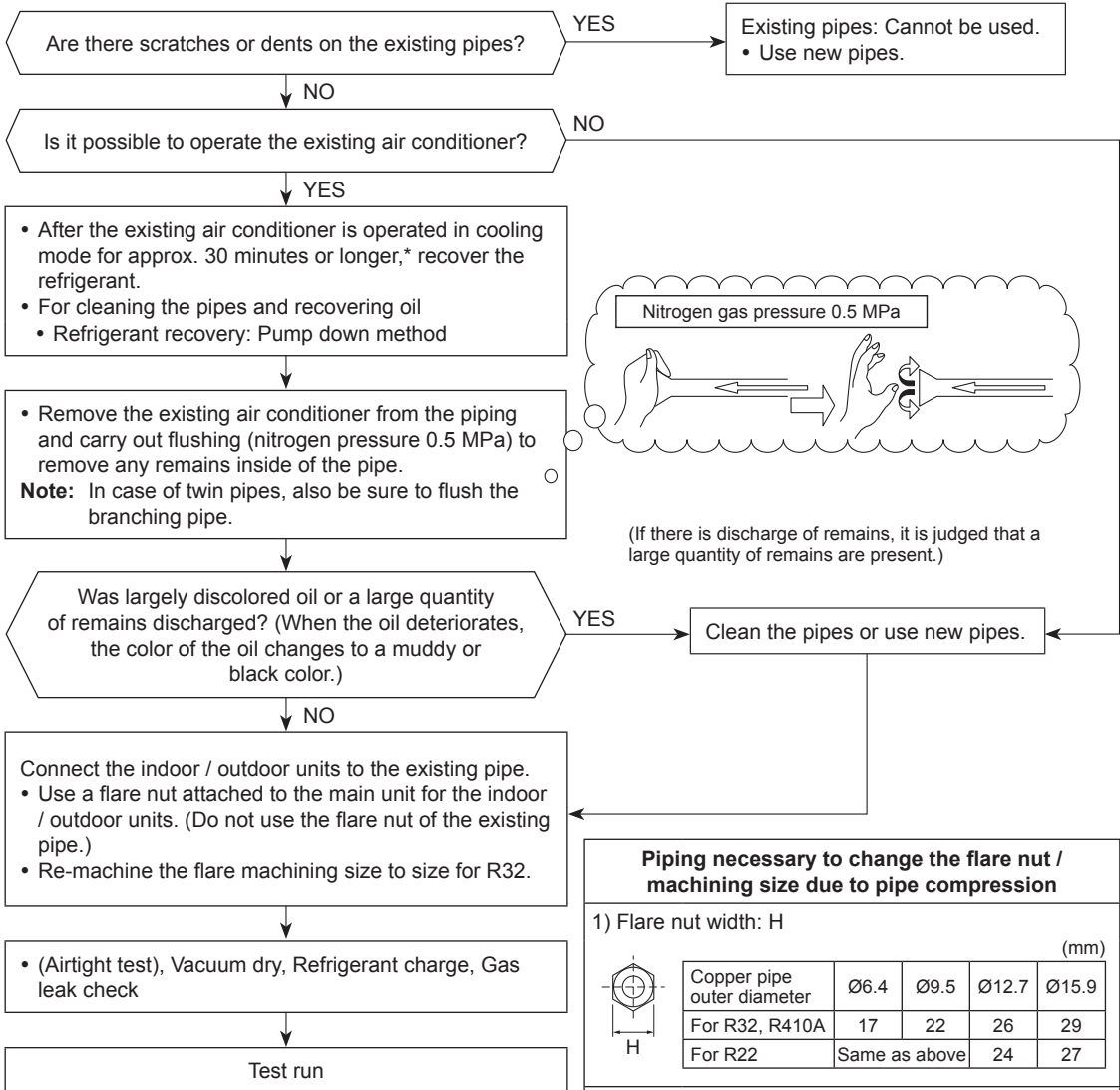

**Piping necessary to change the flare nut / machining size due to pipe compression**

1) Flare nut width: H (mm)

Copper pipe outer diameter	Ø6.4	Ø9.5	Ø12.7	Ø15.9
For R32, R410A	17	22	26	29
For R22	Same as above	24	27	

2) Flare machining size: A (mm)

Copper pipe outer diameter	Ø6.4	Ø9.5	Ø12.7	Ø15.9
For R32, R410A	9.1	13.2	16.6	19.7
For R22	9.0	13.0	16.2	19.4

Becomes a little larger for R32

Do not apply refrigerator oil to the flare surface.

# **Toshiba Carrier (Thailand) Co., Ltd.**

144 / 9 Moo 5, Bangkadi Industrial Park, Tivanon Road, Tambol Bangkadi, Amphur Muang, Pathumthani 12000, Thailand