

Kioto One



Kioto One 1185↑ × 480⇔ S8
colour: RAL 7022

Angled integrated thermostatic valve set with immersion tube, left, chrome
Integrated pipe-masking set, chrome
ONE heating element



TERMA
SINCE 1990



Kioto One



Projekt : *Terma*

Standard connections:

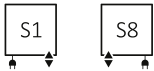

Electric radiators:

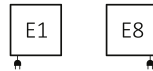

Available sizes:

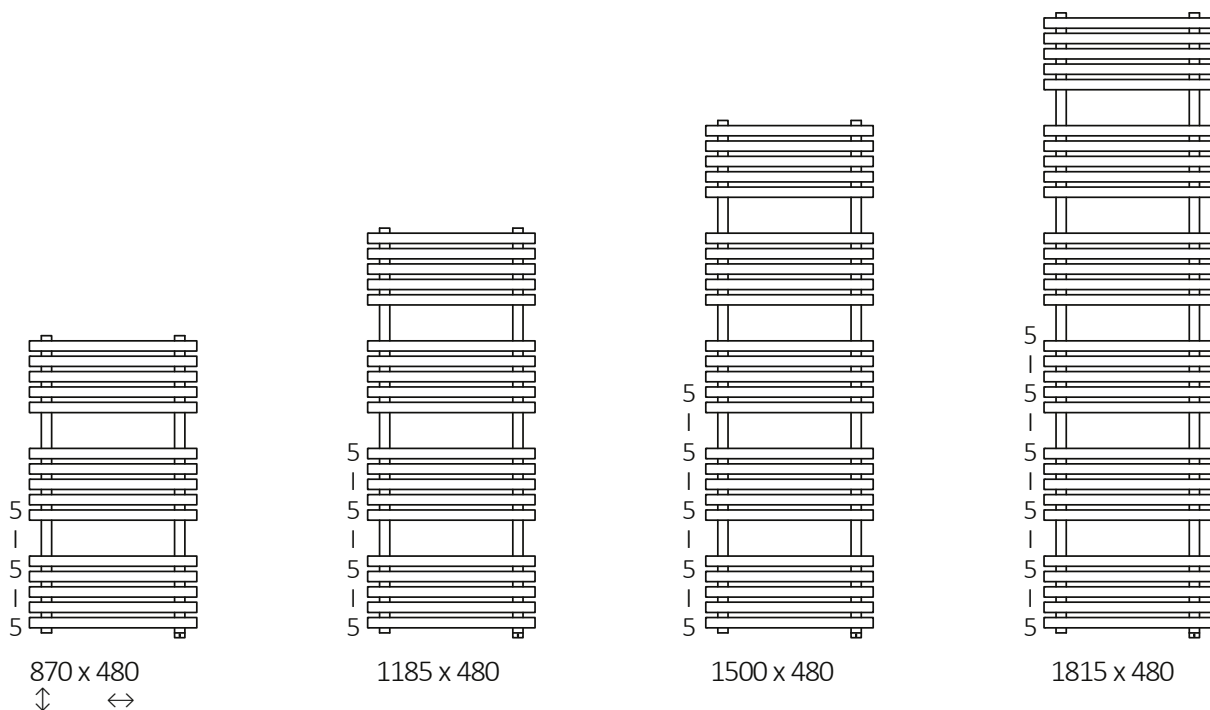



Electrical specification:

Power supply:	230 V / 50 Hz
Device protection class:	Class I
Ingress protection [IP]:	IPx5

Specifications:

Working pressure: 1000 kPa Maximum operating temperature: 82°C

A ↓ [mm]	B ↔ [mm]	75/65/20°C [W]	55/45/20°C [W]	 [W]	D [mm]	E [mm]	F [mm]	 [dm³]	 [kg]	Product Code <small>configuration code p. 5</small>
870	480	476	255	400	390	720	75	2,96	10,7	WZKIN087048
1185	480	628	336	600	390	1035	75	4,00	14,31	WZKIN118048
1500	480	780	415	800	390	1350	75	5,04	17,92	WZKIN150048
1815	480	932	496	1000	390	1665	75	6,08	21,53	WZKIN181048



Technical drawing:

S8

S1

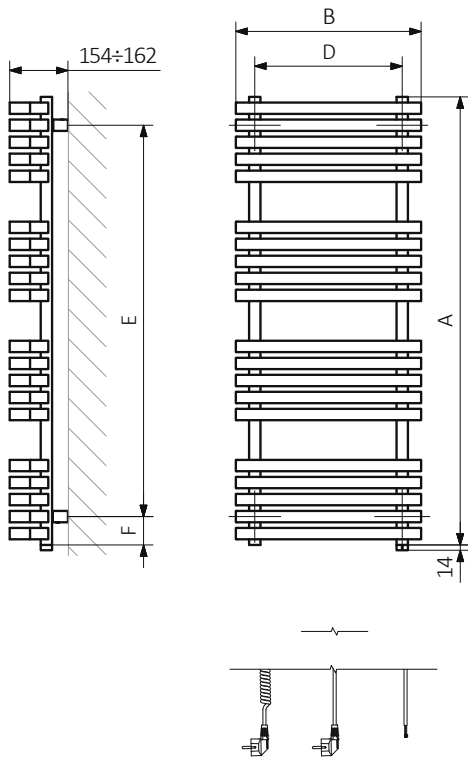
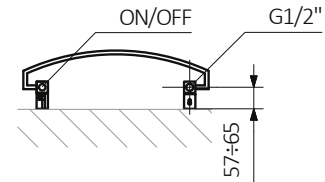
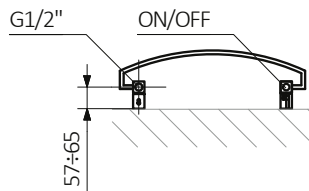

A – Height B – Width C1-C5 – Distance between pipe centres D – Horizontal distance between mounting bracket centres
E – Vertical distance between mounting brackets F – Distance between a mounting bracket and the bottom of the radiator

Collector:

Pipe:

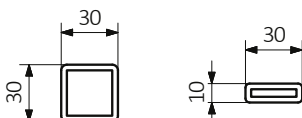



In the table with technical data, the last column lists product codes. When placing an order, please remember to quote the product code followed by the configuration code as shown in the diagram below:

The construction of a configuration code of a water radiator with a built-in One heating element:

WZKIN087048

PRODUCT CODE
(located in the table for the product)

K916S1

CONIGURATION CODE
(supplemented by hand)

Cable Type

W – straight cable with plug
P – straight cable without plug
U – spiral cable with plug

Example Configuration

K 916 S1 W

Package code Plate color code Connection code Cable Type code
K - carton box

The Construction of the product and configuration code for a radiator with the built-in heating element ONE:

WWKIN087048

PRODUCT CODE
(located in the table for the product)

K916E1

CONIGURATION CODE
(supplemented by hand)

Cable Type

W – straight cable with plug
P – straight cable without plug
U – spiral cable with plug

Example Configuration

K 916 E1 P

Package code Plate color code Connection code Cable Type code
K - carton box

Epoxy primer

E – Code of epoxy primer is an extra processes.

WZKIN087048 K916S1 **E** — Extra processes or additions code

Kioto One



Legend



Radiator available in a "water" version.



Radiator suitable for dual fuel connection. Electric heating element can be installed.



Radiator available in electric only version. It comes prefilled with a 'heating medium' and equipped with a heating element. All tested and ready to use.



Connection types dedicated for this radiator. The icon shows the flow and return connections for the radiator as well as the thermostatic valve and heating element position if applicable.



Suggested heating element power output for electric and dual fuel versions.



Weight.



Capacity.



Available in chrome finish.



No additional payment for a color.