

Alex One



Alex One 1140↑ × 600↔ S1
colour: Modern Grey

Angled integrated thermostatic valve set with immersion tube, right, chrome
Integrated pipe-masking set, chrome
ONE heating element



TERMA
SINCE 1990



Alex One



Design: *Terma*

Standard connections:

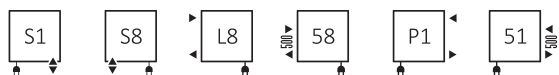

Electric radiators:

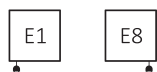

Available sizes:

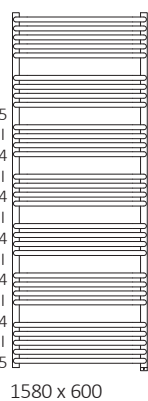
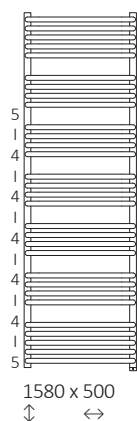
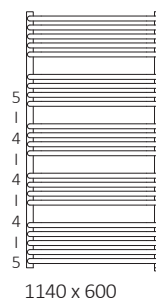
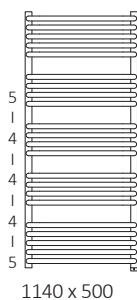
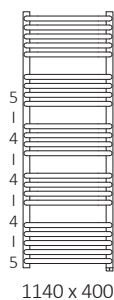
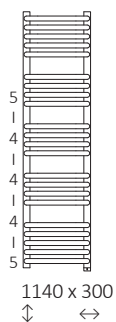
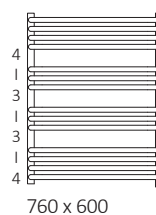
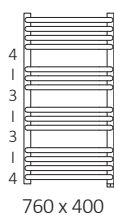
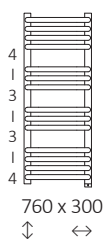





Specifications:

Working pressure: 1000 kPa Maximum operating temperature: 82°C

Electrical specification:

Power supply:	230 V / 50 Hz
Device protection class:	Class I
Ingress protection [IP]:	IPx5

A ↓ [mm]	B ↔ [mm]	75 65 20°C [W]	55 45 20°C [W]	 [W]	D [mm]	E [mm]	F [mm]	 [dm²]	 [kg]	Product Code <small>configuration code p. 10</small>
Paint										
760	300	257	137	300	270	620	70	2,39	5,15	WZALN076030
760	400	330	177	300	370	620	70	2,79	6,08	WZALN076040
760	500	412	220	400	470	620	70	3,19	7,02	WZALN076050
760	600	481	257	600	570	620	70	3,58	7,95	WZALN076060
1140	300	362	194	400	270	1000	70	3,72	7,86	WZALN114030
1140	400	479	257	400	370	1000	70	4,34	9,33	WZALN114040
1140	500	591	313	600	470	1000	70	4,97	10,8	WZALN114050
1140	600	711	380	800	570	1000	70	5,59	12,27	WZALN114060
1580	500	793	425	800	470	1440	70	6,83	14,74	WZALN158050
1580	600	949	508	1000	570	1440	70	7,68	16,75	WZALN158060
1580	700	1104	591	1000	670	1440	70	8,60	18,75	WZALN158070
Plating										
760	300	180	92	200	270	620	70	2,39	4,95	WZALN076030
760	400	231	118	200	370	620	70	2,79	5,85	WZALN076040
760	500	288	147	300	470	620	70	3,19	6,74	WZALN076050
760	600	337	172	400	570	620	70	3,58	7,64	WZALN076060
1140	300	253	129	300	270	1000	70	3,72	7,56	WZALN114030
1140	400	335	171	400	370	1000	70	4,34	8,97	WZALN114040
1140	500	414	211	400	470	1000	70	4,97	10,38	WZALN114050
1140	600	498	254	600	570	1000	70	5,59	11,79	WZALN114060
1580	500	555	283	600	470	1440	70	6,83	14,17	WZALN158050
1580	600	664	339	600	570	1440	70	7,68	16,09	WZALN158060
1580	700	773	394	800	670	1440	70	8,60	18,01	WZALN158070



Technical drawing:

S1

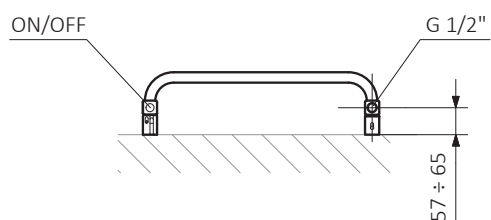

S8

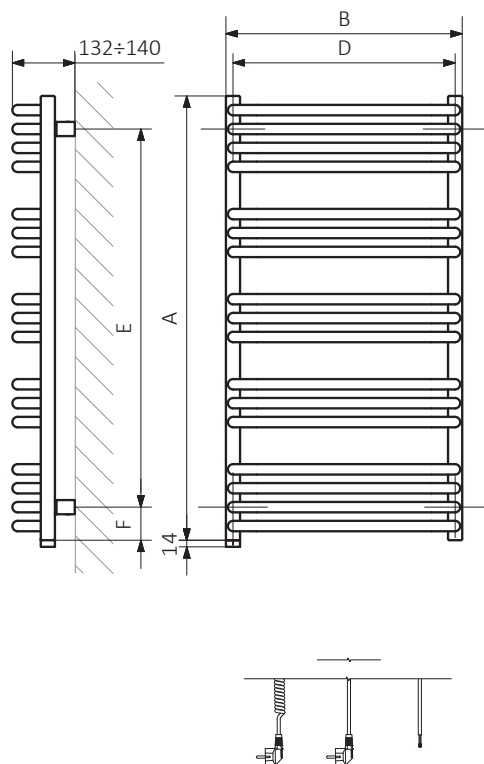
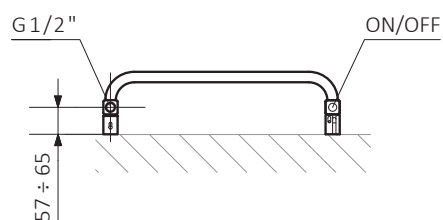

A – Height B – Width C1-C5 – Distance between pipe centres D – Horizontal distance between mounting bracket centres
E – Vertical distance between mounting brackets F – Distance between a mounting bracket and the bottom of the radiator

Collector:

Pipe:

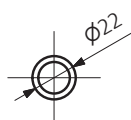
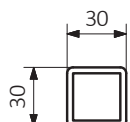



Technical drawing:

L8

58

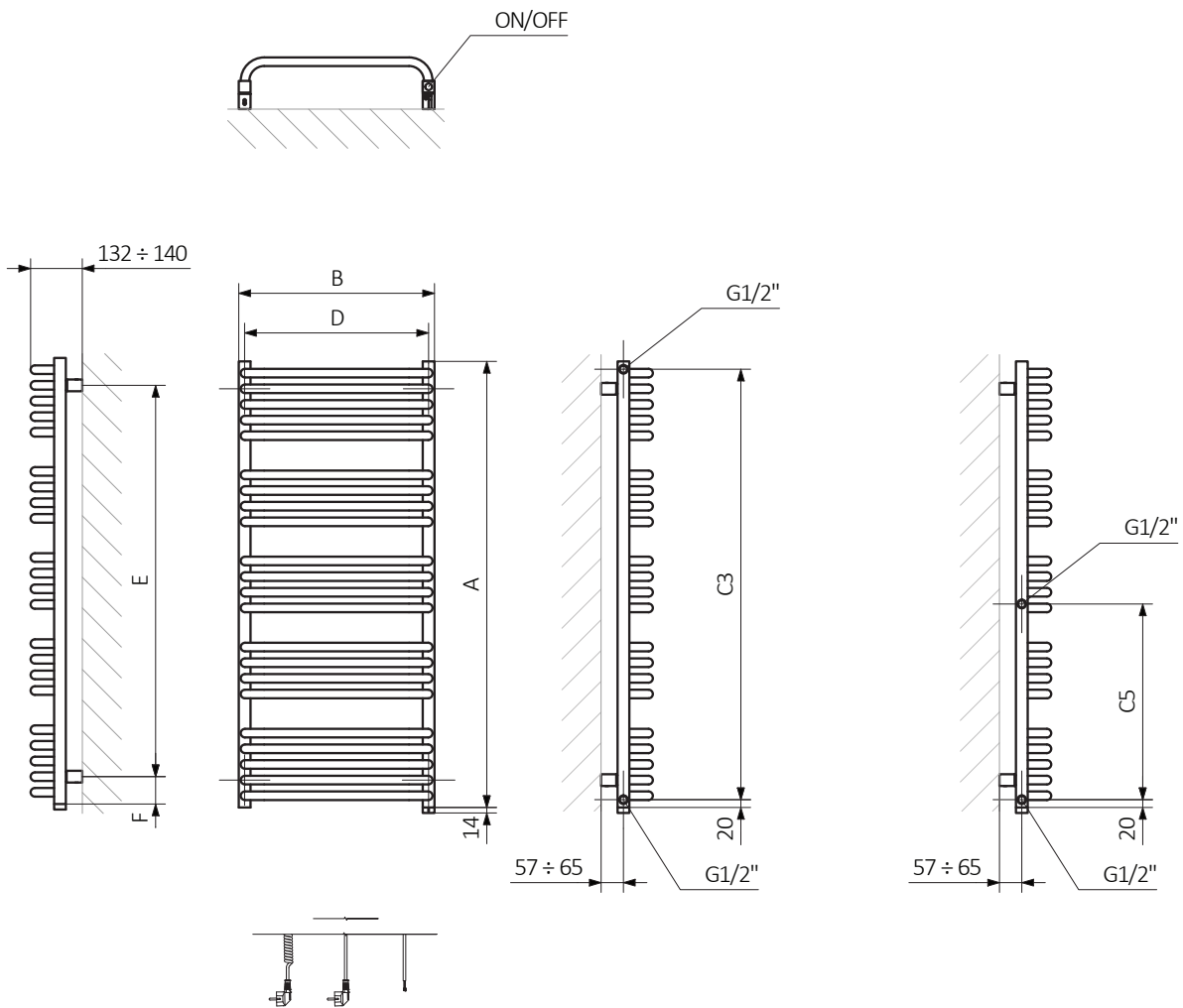

A – Height B – Width C1-C5 – Distance between pipe centres D – Horizontal distance between mounting bracket centres
E – Vertical distance between mounting brackets F – Distance between a mounting bracket and the bottom of the radiator

Collector:

Pipe:

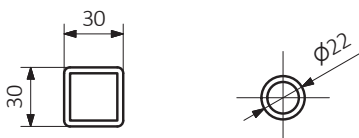



Technical drawing:

P1

51

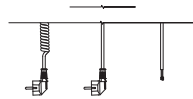
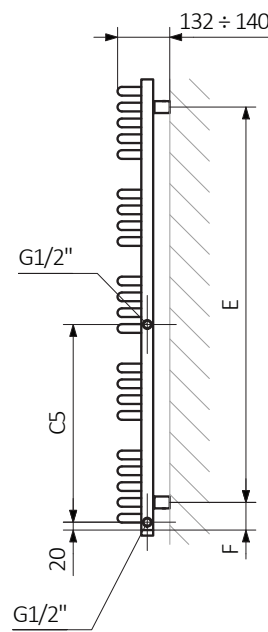
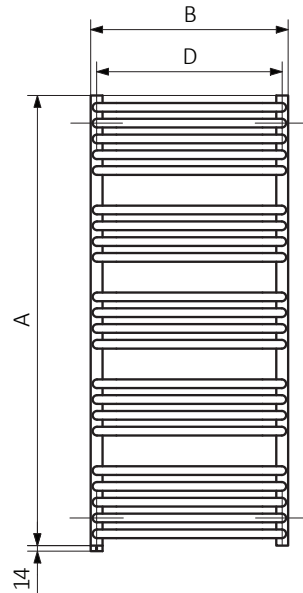
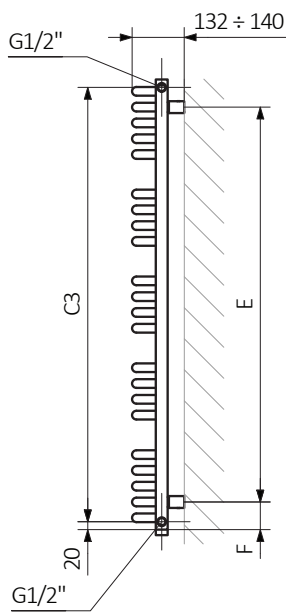
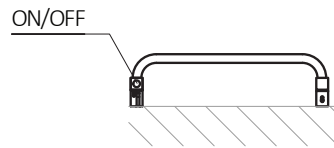

A – Height B – Width C1-C5 – Distance between pipe centres D – Horizontal distance between mounting bracket centres
E – Vertical distance between mounting brackets F – Distance between a mounting bracket and the bottom of the radiator

Collector:

Pipe:

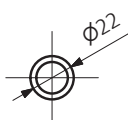
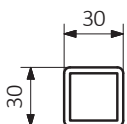



In the table with technical data, the last column lists product codes. When placing an order, please remember to quote the product code followed by the configuration code as shown in the diagram below:

The construction of a configuration code of a water radiator with a built-in One heating element:

WZALN076030

PRODUCT CODE
(located in the table for the product)

K916S1

CONIGURATION CODE
(supplemented by hand)

Cable Type

W – straight cable with plug
P – straight cable without plug
U – spiral cable with plug

Example Configuration

K 916 S1 P

Package code Plate color code Connection code Cable Type code
K - carton box

The Construction of the product and configuration code for a radiator with the built-in heating element ONE:

WWALN076030

PRODUCT CODE
(located in the table for the product)

K916E1

CONIGURATION CODE
(supplemented by hand)

Cable Type

W – straight cable with plug
P – straight cable without plug
U – spiral cable with plug

Example Configuration

K 916 E1 P

Package code Plate color code Connection code Cable Type code
K - carton box

Epoxy primer

E – Code of epoxy primer is an extra processes.

WZALN076030 K916S1 **E** — Extra processes or additions code

Alex One



Legend



Radiator available in a "water" version.



Radiator suitable for dual fuel connection. Electric heating element can be installed.



Radiator available in electric only version. It comes prefilled with a 'heating medium' and equipped with a heating element. All tested and ready to use.



Connection types dedicated for this radiator. The icon shows the flow and return connections for the radiator as well as the thermostatic valve and heating element position if applicable.



Suggested heating element power output for electric and dual fuel versions.



Weight.



Capacity.



Available in chrome finish.



No additional payment for a color.