

Technické náčrty Spirál

Spiral Horizontal - ZEĎ

RA1-W

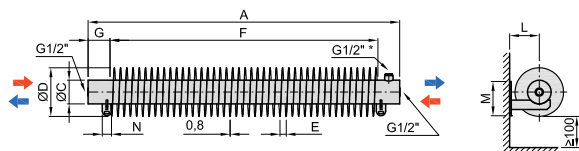

RA1-W	Ø32 x Ø92	Ø57 x Ø137	Ø76 x Ø156	Ø89 x Ø169	Ø108 x Ø188
A	500-6000				
B	-	-	-	-	-
C	32	57	76	89	108
D	92	137	156	169	188
E	10	18	20	20	20
F	A-100	A-140	A-140	A-140	A-140
G	50	70	70	70	70
J	-	-	-	-	-
L	60	85	95	102	111
M	90	100	110	115	125
N	25	30	30	30	35

RAT2-W

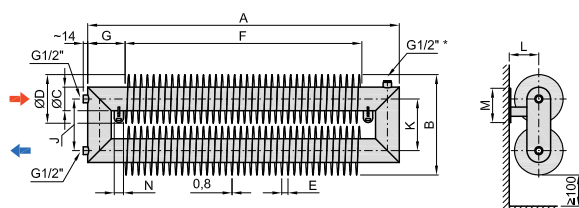

RAT2-W	Ø32 x Ø92	Ø57 x Ø137	Ø76 x Ø156	Ø89 x Ø169	Ø108 x Ø188
A	500-6000				
B	197	283	322	348	386
C	32	57	76	89	108
D	92	137	156	169	188
E	10	18	20	20	20
F	A-130	A-220	A-240	A-260	A-300
G	65	110	120	130	150
J	103	146	166	179	198
K	105	146	166	179	198
L	60	85	95	102	111
M	90	100	110	115	125
N	25	30	30	30	35

RAT3-W

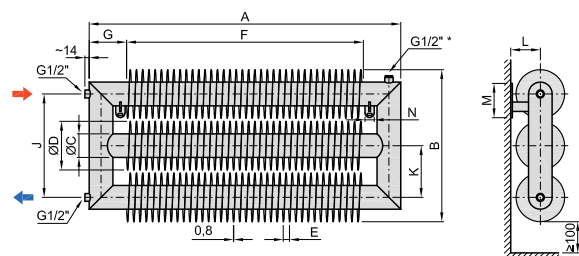

RAT3-W	Ø32 x Ø92	Ø57 x Ø137	Ø76 x Ø156	Ø89 x Ø169	Ø108 x Ø188
A	500-6000				
B	302	429	488	527	584
C	32	57	76	89	108
D	92	137	156	169	188
E	10	18	20	20	20
F	A-130	A-220	A-240	A-260	A-300
G	65	110	120	130	150
J	208	292	332	358	396
K	105	146	166	179	198
L	60	85	95	102	111
M	90	100	110	115	125
N	25	30	30	30	35

RAO2-W

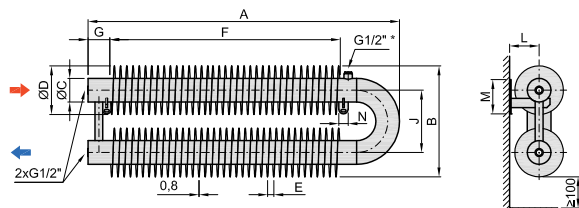

RAO2-W	Ø32 x Ø92	Ø57 x Ø137	Ø76 x Ø156	Ø89 x Ø169	Ø108 x Ø188
A	500-6000				
B	187	282 (312**)	356 (351**)	400	478
C	32	57	76	89	108
D	92	137	156	169	188
E	10	18	20	20	20
F	A-160	A-230	A-260	A-280	A-310
G	50	70	70	70	70
J	95	145 (175**)	200 (195**)	231	290
L	60	85	95	102	111
M	90	100	110	115	125
N	25	30	30	30	35

RAO3-W

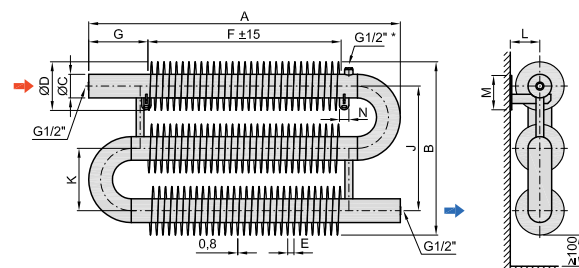

RAO3-W	Ø32 x Ø92	Ø57 x Ø137	Ø76 x Ø156	Ø89 x Ø169	Ø108 x Ø188
A	500-6000				
B	282	427 (487**)	556 (546**)	631	768
C	32	57	76	89	108
D	92	137	156	169	188
E	10	18	20	20	20
F	A-220	A-300	A-380	A-420	A-480
G	110	150	190	210	240
J	190	290 (350**)	400 (390**)	462	580
K	95	145 (175**)	200 (195**)	231	290
L	60	85	95	102	111
M	90	100	110	115	125
N	25	30	30	30	35

Tolerance rozměrů: **F** (délka žebrování) +/- 15 mm / **J** (připojovací rozeť) +/- 2,5 mm

* odvězdušňovací ventil ** nerezové provedení, pouze ø32, 57 a 76 mm

Spiral Horizontal - ZEM

RA1-F

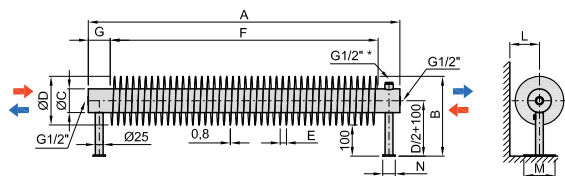

RA1-F	Ø32 x Ø92	Ø57 x Ø137	Ø76 x Ø156	Ø89 x Ø169	Ø108 x Ø188
A	500-6000				
B	192	237	256	269	288
C	32	57	76	89	108
D	92	137	156	169	188
E	10	18	20	20	20
F	A-100	A-140	A-140	A-140	A-140
G	50	70	70	70	70
J	-	-	-	-	-
L	≥60	≥85	≥95	≥102	≥111
M	100	100	100	160	160
N	40	40	40	60	60

RAT2-F

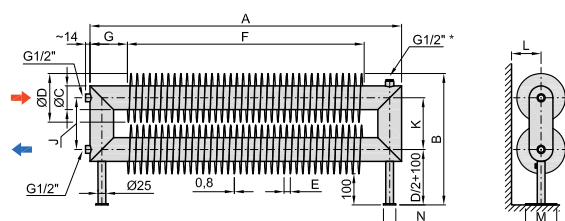

RAT2-F	Ø32 x Ø92	Ø57 x Ø137	Ø76 x Ø156	Ø89 x Ø169	Ø108 x Ø188
A	500-6000				
B	297	383	422	448	486
C	32	57	76	89	108
D	92	137	156	169	188
E	10	18	20	20	20
F	A-130	A-220	A-240	A-260	A-300
G	65	110	120	130	150
J	103	146	166	179	198
K	105	146	166	179	198
L	≥60	≥85	≥95	≥102	≥111
M	100	100	100	160	160
N	40	40	40	60	60

RAT3-F

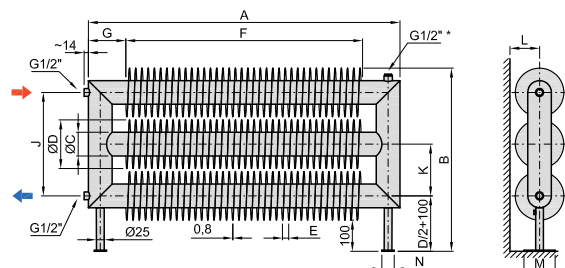

RAT3-F	Ø32 x Ø92	Ø57 x Ø137	Ø76 x Ø156	Ø89 x Ø169	Ø108 x Ø188
A	500-6000				
B	402	529	588	627	684
C	32	57	76	89	108
D	92	137	156	169	188
E	10	18	20	20	20
F	A-130	A-220	A-240	A-260	A-300
G	65	110	120	130	150
J	208	292	332	358	396
K	105	146	166	179	198
L	≥60	≥85	≥95	≥102	≥111
M	100	100	100	160	160
N	40	40	40	60	60

RAO2-F

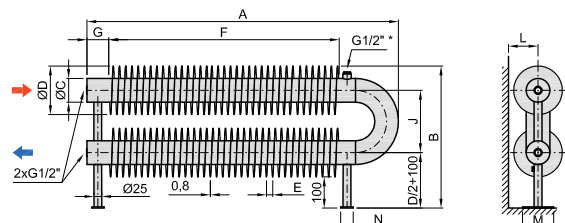

RAO2-F	Ø32 x Ø92	Ø57 x Ø137	Ø76 x Ø156	Ø89 x Ø169	Ø108 x Ø188
A	500-6000				
B	287	382 (412**)	456 (451**)	500	578
C	32	57	76	89	108
D	92	137	156	169	188
E	10	18	20	20	20
F	A-160	A-230	A-260	A-280	A-310
G	50	70	70	70	70
J	95	145 (175**)	200 (195**)	231	290
L	60	85	95	≥102	≥111
M	100	100	100	160	160
N	40	40	40	60	60
N	25	30	30	30	35

RAO3-F

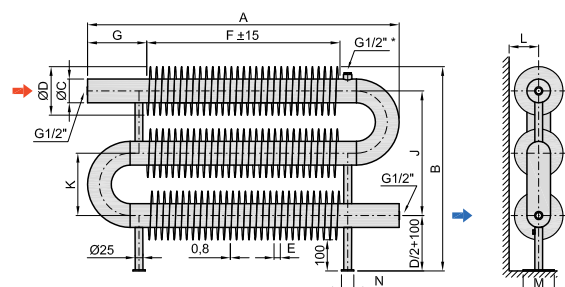

RAO3-F	Ø32 x Ø92	Ø57 x Ø137	Ø76 x Ø156	Ø89 x Ø169	Ø108 x Ø188
A	500-6000				
B	382	527 (587**)	656 (646**)	731	868
C	32	57	76	89	108
D	92	137	156	169	188
E	10	18	20	20	20
F	A-220	A-300	A-380	A-420	A-480
G	110	150	190	210	240
J	190	290 (350**)	400 (390**)	462	580
K	95	145 (175**)	200 (195**)	231	290
L	≥60	≥85	≥95	≥102	≥111
M	100	100	100	160	160
N	40	40	40	60	60

Tolerance rozměrů: **F** (délka žebrování) +/- 15 mm / **J** (připojovací rozték) +/- 2,5 mm

* odvědušňovací ventil ** nerezové provedení, pouze ø32, 57 a 76 mm

Spiral Horizontal - SAMOSTOJNÝ

RAT1-S

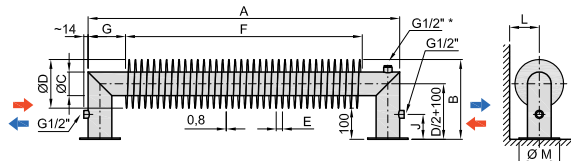

RAT1-S	Ø32 x Ø92	Ø57 x Ø137	Ø76 x Ø156	Ø89 x Ø169	Ø108 x Ø188
A	500-6000				
B	192	237	256	269	288
C	32	57	76	89	108
D	92	137	156	169	188
E	10	18	20	20	20
F	A-130	A-220	A-240	A-260	A-300
G	65	110	120	130	150
J	80	80	80	80	80
L	≥60	≥85	≥95	≥102	≥111
M	76	130	130	150	150
N	25	30	30	30	35

RAT2-S

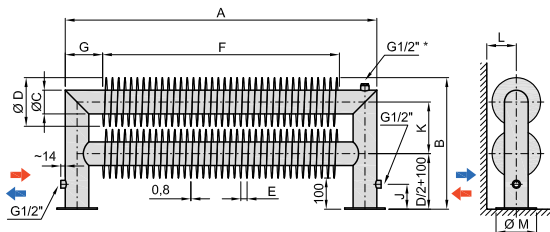

RAT2-S	Ø32 x Ø92	Ø57 x Ø137	Ø76 x Ø156	Ø89 x Ø169	Ø108 x Ø188
A	500-6000				
B	297	383	422	448	486
C	32	57	76	89	108
D	92	137	156	169	188
E	10	18	20	20	20
F	A-130	A-220	A-240	A-260	A-300
G	65	110	120	130	150
J	80	80	80	80	80
K	105	146	166	179	198
L	≥60	≥85	≥95	≥102	≥111
M	76	130	130	150	150
N	-	-	-	-	-

RAT3-S

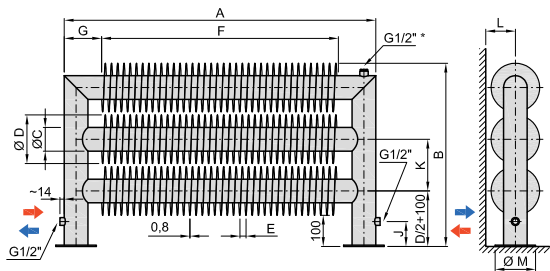

RAT3-S	Ø32 x Ø92	Ø57 x Ø137	Ø76 x Ø156	Ø89 x Ø169	Ø108 x Ø188
A	500-6000				
B	402	529	588	627	684
C	32	57	76	89	108
D	92	137	156	169	188
E	10	18	20	20	20
F	A-130	A-220	A-240	A-260	A-300
G	65	110	120	130	150
J	80	80	80	80	80
K	105	146	166	179	198
L	≥60	≥85	≥95	≥102	≥111
M	76	130	130	150	150
N	-	-	-	-	-

Tolerance rozměrů: **F** (délka žebrování) +/- 15 mm / **J** (připojovací rosteč) +/- 2,5 mm

* odvědušňovací ventil ** nerezové provedení, pouze ø32, 57 a 76 mm

Spiral Vertikal - ZEĎ

RA1-V

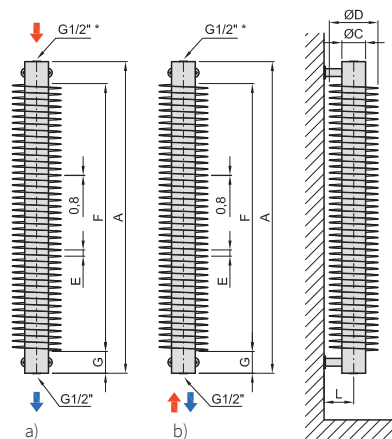

Těleso nemá odvzdušňovací ventil, je nutné odvzdušňovat na horním přívodním potrubí a) nebo použít jednobodový ventil b)

RA1-V		Ø32 x Ø92	Ø57 x Ø137	Ø76 x Ø156	Ø89 x Ø169	Ø108 x Ø188
Rozměry [mm]	A	500-2500				
	B	-	-	-	-	-
	C	32	57	76	89	108
	D	92	137	156	169	188
	E	10	18	20	20	20
	F	A-100	A-140	A-140	A-140	A-140
	G	50	70	70	70	70
	J	-	-	-	-	-
	K	-	-	-	-	-
	L	60	85	95	102	111
	N	40	40	40	60	60

Poznámka: možnost b) není k dispozici pro ø32 mm

RAT2-V

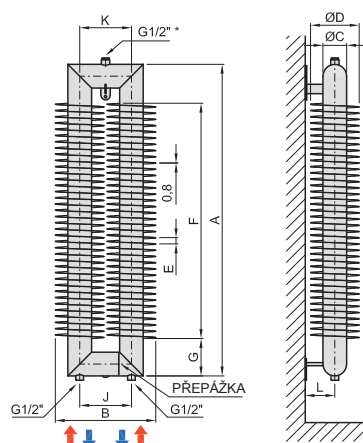

RAT2-V		Ø32 x Ø92	Ø57 x Ø137	Ø76 x Ø156	Ø89 x Ø169	Ø108 x Ø188
Rozměry [mm]	A	500-2500				
	B	197	283	322	348	386
	C	32	57	76	89	108
	D	92	137	156	169	188
	E	10	18	20	20	20
	F	A-130	A-220	A-240	A-260	A-300
	G	65	110	120	130	150
	J	103	146	166	179	198
	K	105	146	166	179	198
	L	60	85	95	102	111
	N	40	40	40	60	60

RAT3-V

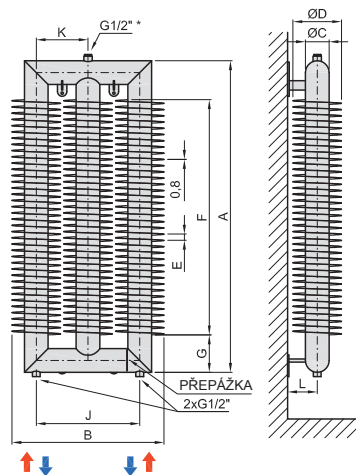

RAT3-V		Ø32 x Ø92	Ø57 x Ø137	Ø76 x Ø156	Ø89 x Ø169	Ø108 x Ø188
Rozměry [mm]	A	500-2500				
	B	302	429	488	527	584
	C	32	57	76	89	108
	D	92	137	156	169	188
	E	10	18	20	20	20
	F	A-130	A-220	A-240	A-260	A-300
	G	65	110	120	130	150
	J	208	292	332	358	396
	K	105	146	166	179	198
	L	60	85	95	102	111
	N	40	40	40	60	60

RAO2-V

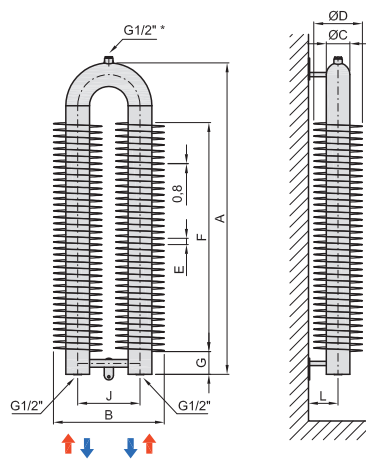

RAO2-V		Ø32 x Ø92	Ø57 x Ø137	Ø76 x Ø156	Ø89 x Ø169	Ø108 x Ø188
Rozměry [mm]	A	500-2500				
	B	187	282 (312**)	356 (351**)	400	478
	C	32	57	76	89	108
	D	92	137	156	169	188
	E	10	18	20	20	20
	F	A-160	A-230	A-260	A-280	A-320
	G	50	70	70	70	70
	J	95	145 (175**)	200 (195**)	231	290
	K	-	-	-	-	-
	L	60	85	95	102	111
	N	40	40	40	60	60

Tolerance rozměrů: **F** (délka žebrování) +/- 15 mm / **J** (připojovací roztče) +/- 2,5 mm

*odvzdušňovací ventil ** nerezové provedení, pouze ø32, 57 a 76 mm